

Product Summary

- 20V/-7 A
- $R_{DS(ON)} = 22m\Omega(Typ.)@V_{GS}=-4.5V$
- $R_{DS(ON)} = 26m\Omega(Typ.)@V_{GS}=-2.5V$

Application

- Battery Pack
- Portable Devices

Package and Pin Configuration

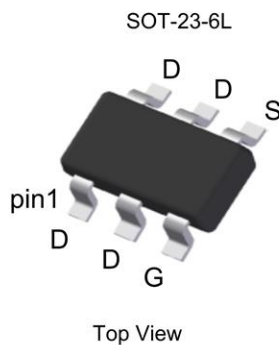

Circuit diagram

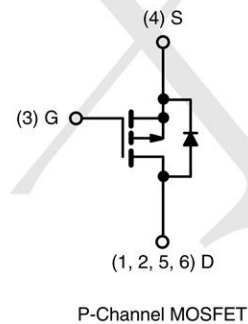

Marking:

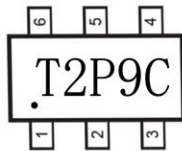

Absolute Maximum Ratings ($T_A=25^{\circ}C$ unless otherwise noted)

PARAMETER	SYMBOL	LIMIT	UNIT
Drain-Source Voltage	V_{DS}	-20	V
Gate-Source Voltage	V_{GS}	± 12	V
Continuous Drain Current	I_D	$T_C = 25^{\circ}C$	-7
		$T_C = 100^{\circ}C$	-4.9
Pulsed Drain Current (Note 1)	I_{DM}	-26	A
Total Power Dissipation	$P_{D(TOT)}$	1.56	W
Operating Junction Temperature	T_J	150	$^{\circ}C$
Operating Junction and Storage Temperature Range	T_J, T_{STG}	- 55 to +150	$^{\circ}C$

Thermal Characteristic

PARAMETER	SYMBOL	LIMIT	UNIT
Junction to Ambient Thermal Resistance	$R_{\theta JA}$	80	$^{\circ}C/W$

Electrical Characteristics ($T_A=25^\circ\text{C}$ unless otherwise noted)

PARAMETER	CONDITIONS	SYMBOL	MIN	TYP	MAX	UNIT
Static (Note 2)						
Drain-Source Breakdown Voltage	$V_{GS} = 0V, I_D = -250\mu A$	BV_{DSS}	-20	--	--	V
Gate Threshold Voltage	$V_{DS} = V_{GS}, I_D = -250\mu A$	$V_{GS(TH)}$	-0.4	--	-1.1	V
Gate Body Leakage	$V_{GS} = \pm 12V, V_{DS} = 0V$	I_{GSS}	--	--	± 100	nA
Zero Gate Voltage Drain Current	$V_{DS} = -20V, V_{GS} = 0V$	I_{DSS}	--	--	-1	μA
	$V_{DS} = -16V, T_J = 125^\circ\text{C}$		--	--	-10	
Drain-Source On-State Resistance	$V_{GS} = -4.5V, I_D = -5A$	$R_{DS(on)}$	--	22	26	m Ω
	$V_{GS} = -2.5V, I_D = -4A$		--	26	32	
	$V_{GS} = -1.8V, I_D = -3A$		--	32	40	
Forward Transconductance	$V_{DS} = -10V, I_S = -5A$	g_{fs}	--	15	--	S
Dynamic (Note 3)						
Total Gate Charge	$V_{DS} = -10V, I_D = -5A,$ $V_{GS} = -4.5V$	Q_g	--	19.5	--	nC
Gate-Source Charge		Q_{gs}	--	2	--	
Gate-Drain Charge		Q_{gd}	--	3.6	--	
Input Capacitance	$V_{DS} = -15V, V_{GS} = 0V,$ $F = 1.0\text{MHz}$	C_{iss}	--	1670	--	pF
Output Capacitance		C_{oss}	--	220	--	
Reverse Transfer Capacitance		C_{rss}	--	120	--	
Switching						
Turn-On Delay Time	$V_{DD} = -10V, I_D = -1A,$ $V_{GS} = -4.5V,$ $R_{GEN} = 25\Omega$	$t_{d(on)}$	--	10.4	--	ns
Turn-On Rise Time		t_r	--	37.5	--	
Turn-Off Delay Time		$t_{d(off)}$	--	89.1	--	
Turn-Off Fall Time		t_f	--	24.6	--	
Source-Drain Diode						
Forward Voltage	$V_{GS} = 0V, I_S = -1A$	V_{SD}	--	--	-1	V
Continuous Forward Current	Integral reverse diode in the MOSFET	I_S	--	--	-7	A
Pulse Forward Current		I_{SM}	--	--	-26	A

Typical Electrical and Thermal Characteristics

Continuous Drain Current vs. T_c

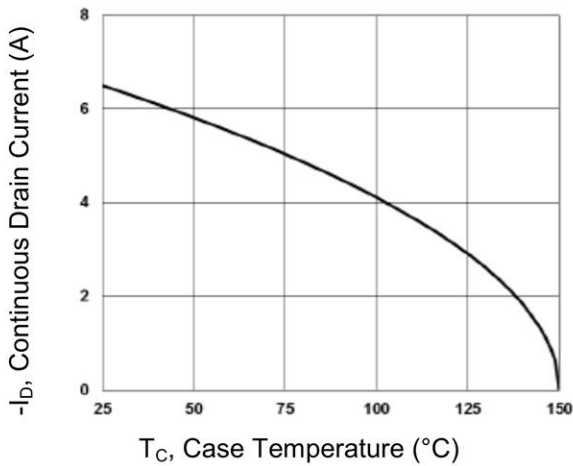

Gate Charge

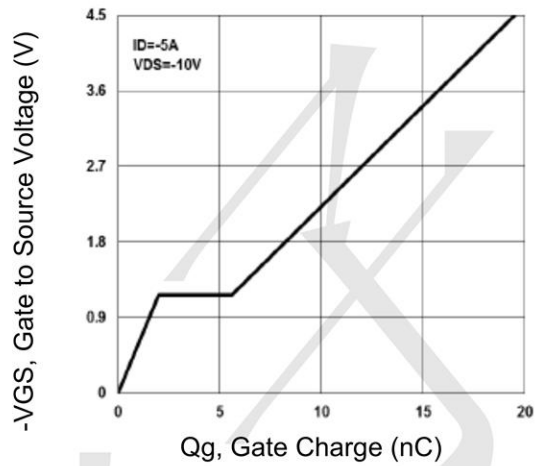

On-Resistance vs. Junction Temperature

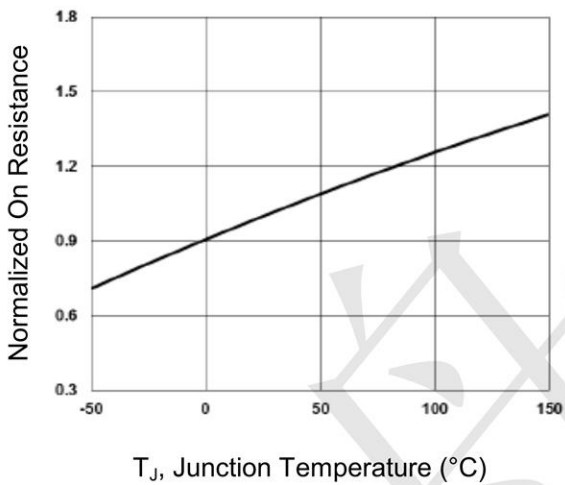

Threshold Voltage vs. Junction Temperature

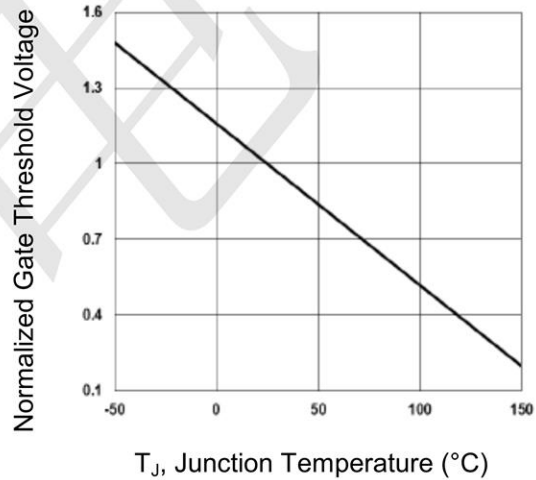

Maximum Safe Operating Area

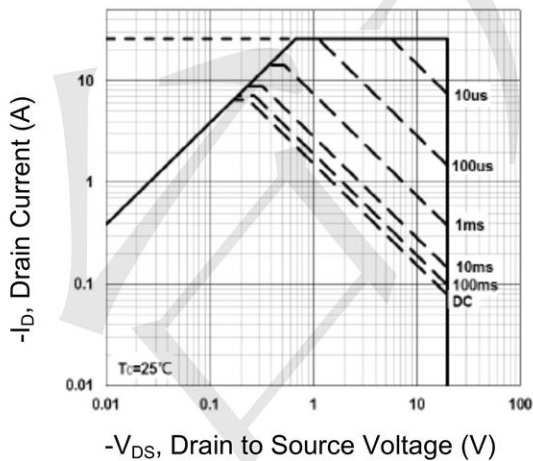

Normalized Thermal Transient Impedance Curve

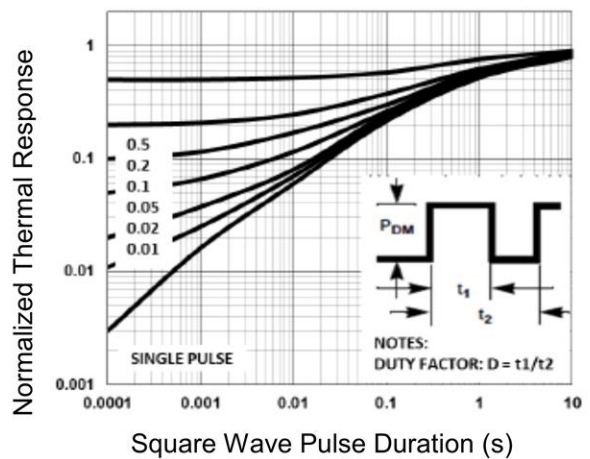



SOT-23-6L Package Outline Dimensions

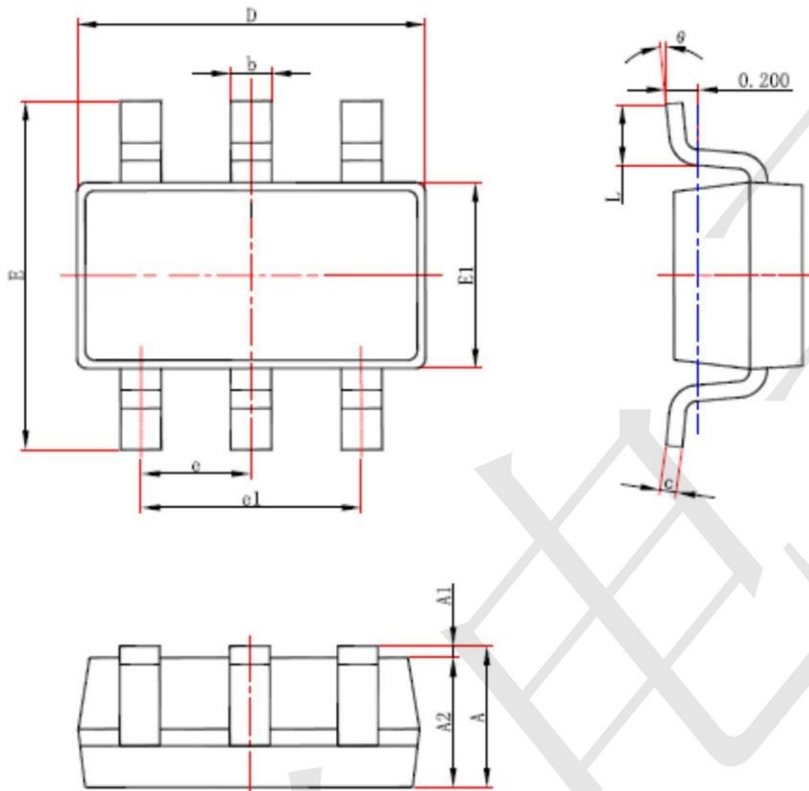

Symbol	Dimensions In Millimeters		Dimensions In Inches	
	Min.	Max.	Min.	Max.
A	1.050	1.250	0.041	0.049
A1	0.000	0.100	0.000	0.004
A2	1.050	1.150	0.041	0.045
b	0.300	0.500	0.012	0.020
c	0.100	0.200	0.004	0.008
D	2.820	3.020	0.111	0.119
E1	1.500	1.700	0.059	0.067
E	2.650	2.950	0.104	0.116
e	0.950(BSC)		0.037(BSC)	
e1	1.800	2.000	0.071	0.079
L	0.300	0.600	0.012	0.024
θ	0°	8°	0°	8°