



SGM8263-1/SGM8263-2

Ultra-Low Offset Voltage, High Linearity, Low Noise Operational Amplifiers

GENERAL DESCRIPTION

The single SGM8263-1 and dual SGM8263-2 are bipolar-input, low noise operational amplifiers optimized for high voltage systems. These devices operate from 4V to 36V single supply or from $\pm 2V$ to $\pm 18V$ dual power supplies, while consuming 2.5mA quiescent current per amplifier.

The SGM8263-1/2 have impressive dynamic characteristics with various loads. The rail-to-rail output swing with a 2k Ω load is within 190mV of the rails. This results in large headroom and wide dynamic range. The SGM8263-1/2 are unity-gain stable and offer a $\pm 55mA$ high output current. They feature 4.5nV/ \sqrt{Hz} ultra-low noise at 1kHz with 0.0001% distortion.

The SGM8263-1/2 also offer an 8.5 μV maximum offset voltage and ultra-low offset voltage drift over temperature. The combination of above features makes these devices appropriate for amplifying low noise and low amplitude signal.

The SGM8263-1 is available in Green SOT-23-5 and SOIC-8 packages. The SGM8263-2 is available in a Green SOIC-8 package. They are specified from -40°C to +85°C temperature range.

FEATURES

- **Ultra-Low Offset Voltage: 8.5 μV (MAX)**
- **Ultra-Low Input Offset Voltage Drift: 10nV/°C**
- **Low Input Voltage Noise: 4.5nV/ \sqrt{Hz} at 1kHz**
- **Low Distortion: 0.0001% at 1kHz**
- **Unity-Gain Stable**
- **Gain-Bandwidth Product: 10MHz (G = +1)**
- **High Slew Rate: 10V/ μs**
- **High Open-Loop Gain: 145dB**
- **Rail-to-Rail Output**
- **Support Single or Dual Power Supplies:
4V to 36V or $\pm 2V$ to $\pm 18V$**
- **Low Quiescent Current: 2.5mA/Amplifier**
- **-40°C to +85°C Operating Temperature Range**
- **Small Packaging:
SGM8263-1 Available in Green SOT-23-5 and SOIC-8 Packages
SGM8263-2 Available in a Green SOIC-8 Package**

APPLICATIONS

Temperature Measurements
Pressure Sensors
Precision Current Sensing
Electronic Scales
Strain Gauge Amplifiers
Medical Instrumentation
Thermocouple Amplifiers
Handheld Test Equipment

PACKAGE/ORDERING INFORMATION

MODEL	PACKAGE DESCRIPTION	SPECIFIED TEMPERATURE RANGE	ORDERING NUMBER	PACKAGE MARKING	PACKING OPTION
SGM8263-1	SOT-23-5	-40°C to +85°C	SGM8263-1YN5G/TR	GJ8XX	Tape and Reel, 3000
	SOIC-8	-40°C to +85°C	SGM8263-1YS8G/TR	SGM 82631YS8 XXXXX	Tape and Reel, 4000
SGM8263-2	SOIC-8	-40°C to +85°C	SGM8263-2YS8G/TR	SGM 82632YS8 XXXXX	Tape and Reel, 4000

MARKING INFORMATION

NOTE: XX = Date Code. XXXXX = Date Code and Vendor Code.

SOT-23-5

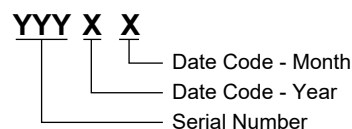

SOIC-8

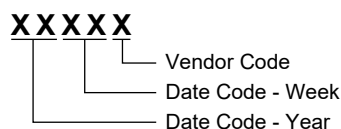

Green (RoHS & HSF): SG Micro Corp defines "Green" to mean Pb-Free (RoHS compatible) and free of halogen substances. If you have additional comments or questions, please contact your SGMICRO representative directly.

ABSOLUTE MAXIMUM RATINGS

- Supply Voltage, +V_S to -V_S 40V
- Input Voltage Range (-V_S) - 0.3V to (+V_S) + 0.3V
- Input Current (All pins except power supply pins)..... ±10mA
- Output Short-Circuit Current ±80mA
- Junction Temperature +150°C
- Storage Temperature Range..... -65°C to +150°C
- Lead Temperature (Soldering, 10s) +260°C
- ESD Susceptibility
- HBM (SGM8263-1) 3000V
- HBM (SGM8263-2) 5000V
- MM (SGM8263-1) 200V
- MM (SGM8263-2) 300V
- CDM 1000V

RECOMMENDED OPERATING CONDITIONS

- Operating Temperature Range -40°C to +85°C

OVERSTRESS CAUTION

Stresses beyond those listed in Absolute Maximum Ratings may cause permanent damage to the device. Exposure to absolute maximum rating conditions for extended periods may affect reliability. Functional operation of the device at any conditions beyond those indicated in the Recommended Operating Conditions section is not implied.

ESD SENSITIVITY CAUTION

This integrated circuit can be damaged if ESD protections are not considered carefully. SGMICRO recommends that all integrated circuits be handled with appropriate precautions. Failure to observe proper handling and installation procedures can cause damage. ESD damage can range from subtle performance degradation to complete device failure. Precision integrated circuits may be more susceptible to damage because even small parametric changes could cause the device not to meet the published specifications.

DISCLAIMER

SG Micro Corp reserves the right to make any change in circuit design, or specifications without prior notice.

PIN CONFIGURATIONS

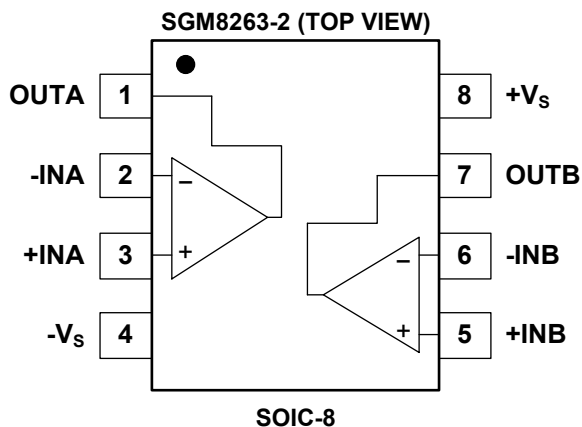
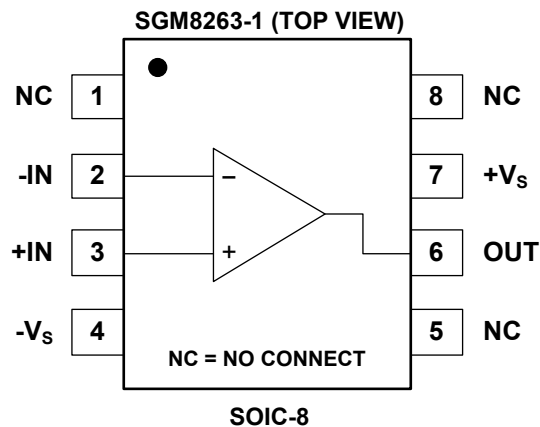
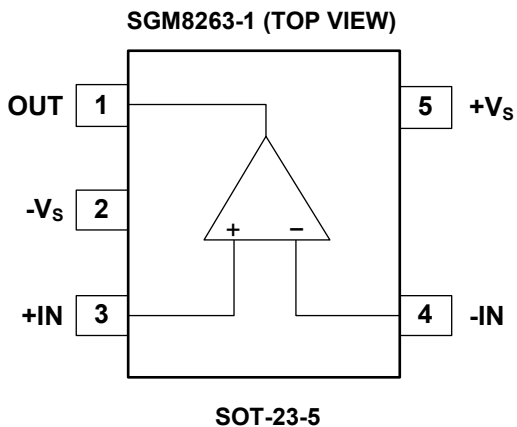

ELECTRICAL CHARACTERISTICS

(At $T_A = +25^\circ\text{C}$, $V_S = 4.5\text{V to } 36\text{V}$ or $V_S = \pm 2.25\text{V to } \pm 18\text{V}$, $R_L = 2\text{k}\Omega$, $V_{CM} = V_{OUT} = V_S/2$, Full = $-40^\circ\text{C to } +85^\circ\text{C}$, unless otherwise noted.)

PARAMETER	SYMBOL	CONDITIONS	TEMP	MIN	TYP	MAX	UNITS
Input Characteristics							
Input Offset Voltage	V_{OS}	$V_S = \pm 15\text{V}$	+25°C		1.5	8.5	μV
			Full			10	
Input Offset Voltage Drift	$\Delta V_{OS}/\Delta T$		Full		10		$\text{nV}/^\circ\text{C}$
Input Bias Current	I_B	$V_{CM} = 0\text{V}$	+25°C		± 60	± 300	nA
			Full			± 350	
Input Offset Current	I_{OS}	$V_{CM} = 0\text{V}$	+25°C		± 20	± 190	nA
			Full			± 210	
Input Common Mode Voltage Range	V_{CM}		Full	$(-V_S) + 2$		$(+V_S) - 2$	V
Common Mode Rejection Ratio	CMRR	$(-V_S) + 2\text{V} \leq V_{CM} \leq (+V_S) - 2\text{V}$	+25°C	107	135		dB
			Full	102			
Open-Loop Voltage Gain	A_{OL}	$(-V_S) + 0.2\text{V} \leq V_{OUT} \leq (+V_S) - 0.2\text{V}$, $R_L = 10\text{k}\Omega$	+25°C	118	145		dB
			Full	115			
			+25°C	115	145		
			Full	112			
Input Impedance							
Differential			+25°C		$16\text{k} \parallel 10$		$\Omega \parallel \text{pF}$
Common Mode			+25°C		$10^9 \parallel 10$		$\Omega \parallel \text{pF}$
Output Characteristics							
Output Voltage Swing from Rail		$R_L = 10\text{k}\Omega$	+25°C		40	75	mV
			Full			85	
			+25°C		190	320	
			Full			360	
Output Short-Circuit Current	I_{SC}		+25°C	± 36	± 55		mA
			Full	± 27			
Dynamic Performance							
Gain-Bandwidth Product	GBP	$G = +1$	+25°C		10		MHz
Phase Margin	ϕ_O	$V_{OUT} = 100\text{mV}_{P-P}$, $R_L = 2\text{k}\Omega$, $C_L = 10\text{pF}$	+25°C		50		°
Slew Rate	SR	$G = -1$, $V_{OUT} = 2\text{V}_{P-P}$	+25°C		10		$\text{V}/\mu\text{s}$
Settling Time to 0.1%	t_S	10V step, $G = +1$	+25°C		3		μs
Overload Recovery Time		$V_{IN} \times G > V_S$	+25°C		0.2		μs
Total Harmonic Distortion + Noise	THD+N	$G = +1$, $V_{OUT} = 1\text{V}_{RMS}$, $f = 1\text{kHz}$, $\text{BW} = 80\text{kHz}$	+25°C		0.0001		%
Noise Performance							
Input Voltage Noise		$f = 0.1\text{Hz to } 10\text{Hz}$	+25°C		100		nV_{P-P}
Input Voltage Noise Density	e_n	$f = 1\text{kHz}$	+25°C		4.5		$\text{nV}/\sqrt{\text{Hz}}$
Input Current Noise Density	i_n	$f = 1\text{kHz}$	+25°C		5		$\text{pA}/\sqrt{\text{Hz}}$
Power Supply							
Supply Voltage	V_S		Full	± 2		± 18	V
Quiescent Current/Amplifier	I_Q	$I_{OUT} = 0\text{A}$	+25°C		2.5	3.2	mA
			Full			3.4	
Power Supply Rejection Ratio	PSRR	$V_S = \pm 2\text{V to } \pm 18\text{V}$	+25°C		0.02	0.4	$\mu\text{V}/\text{V}$
			Full			0.6	

TYPICAL PERFORMANCE CHARACTERISTICS

At $T_A = +25^\circ\text{C}$, $V_S = \pm 18\text{V}$ and $R_L = 10\text{k}\Omega$, unless otherwise noted.

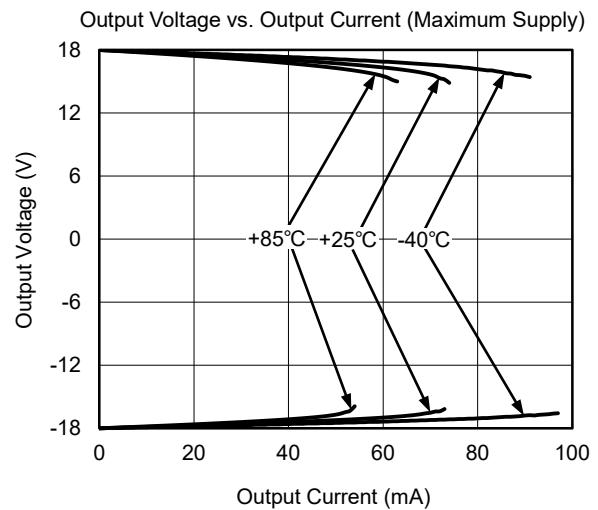
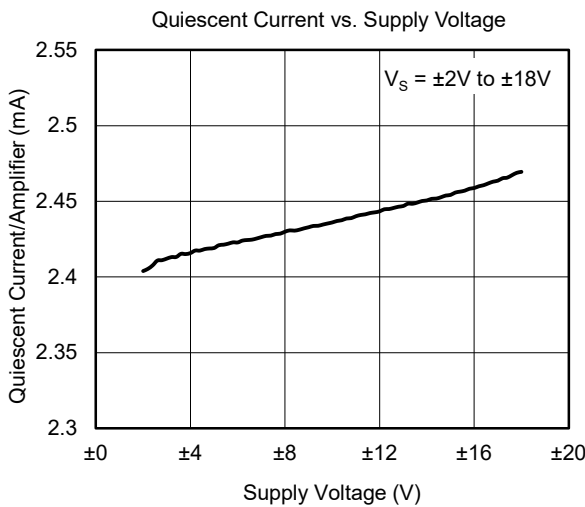
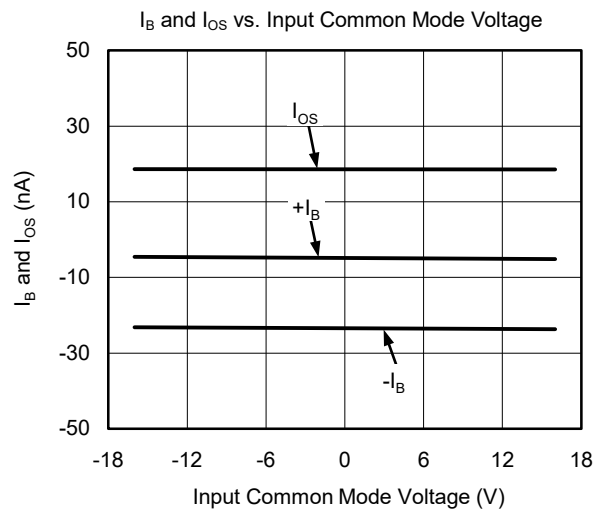
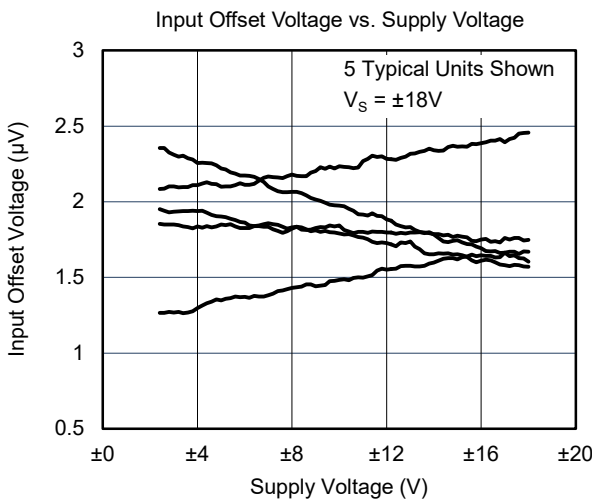
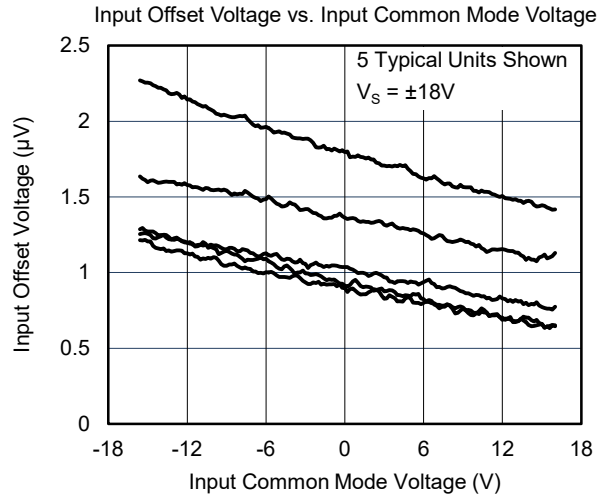
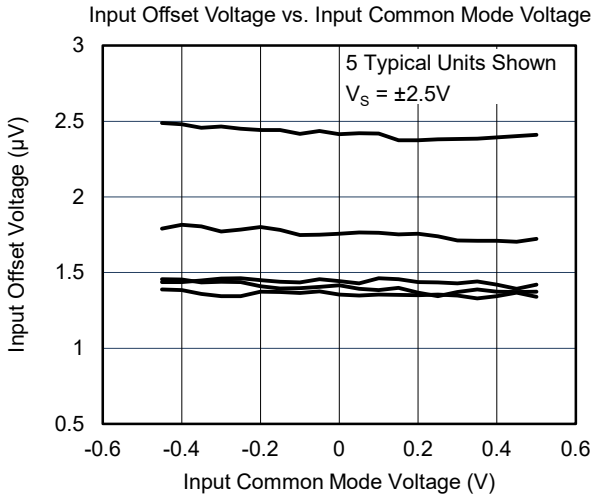

TYPICAL PERFORMANCE CHARACTERISTICS (continued)

At $T_A = +25^\circ\text{C}$, $V_S = \pm 18\text{V}$ and $R_L = 10\text{k}\Omega$, unless otherwise noted.

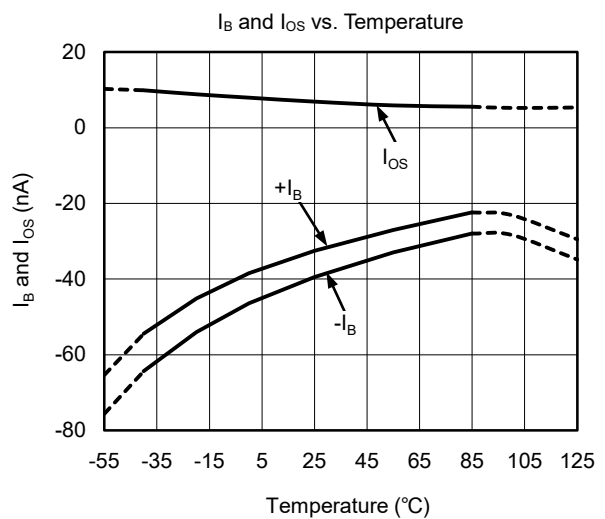
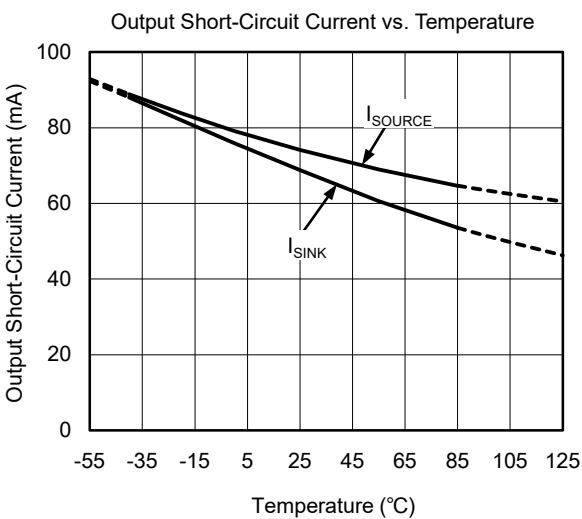
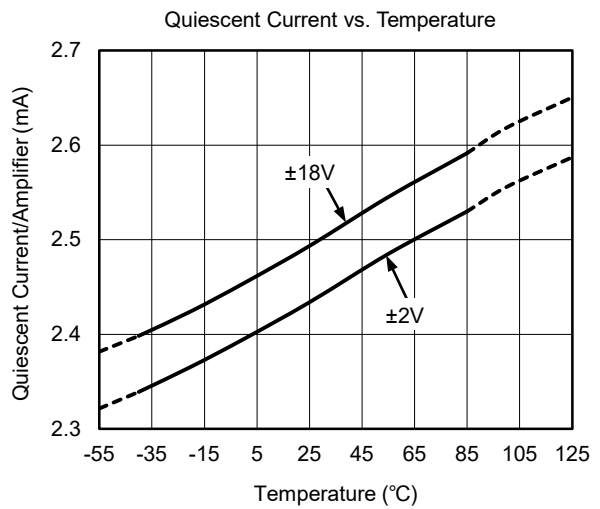
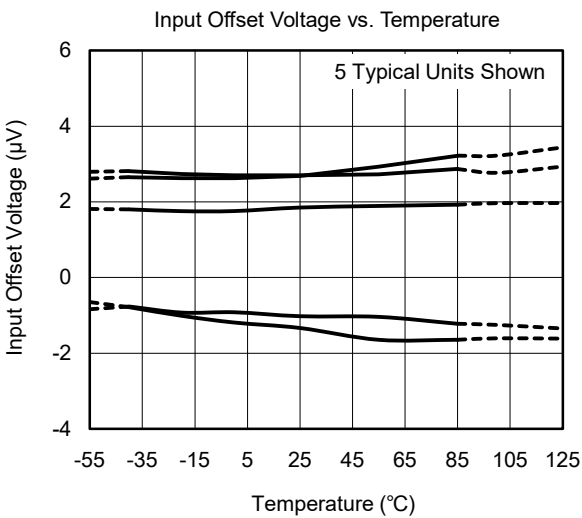
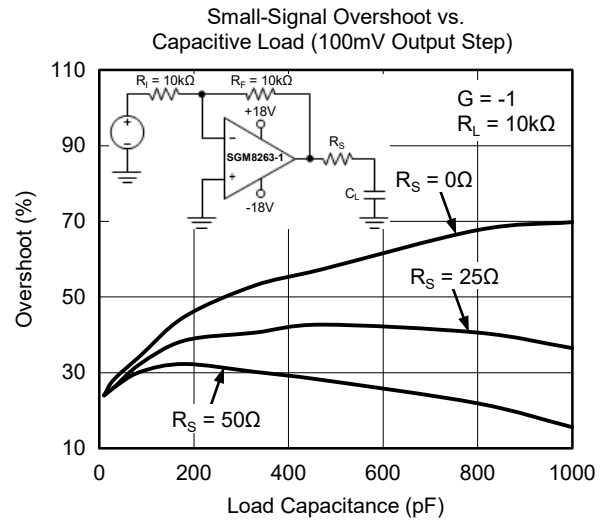
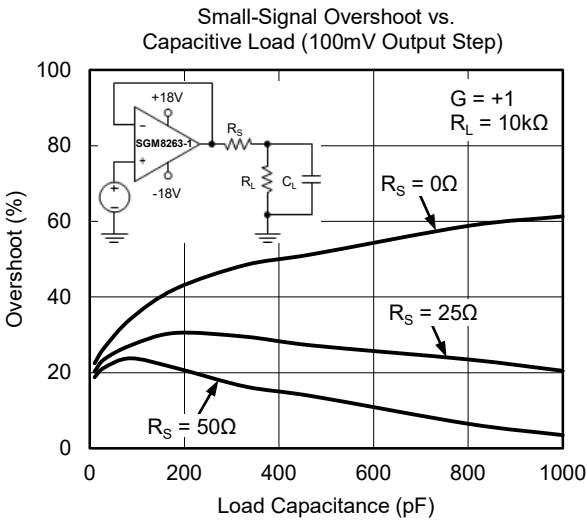

TYPICAL PERFORMANCE CHARACTERISTICS (continued)

At $T_A = +25^\circ\text{C}$, $V_S = \pm 18\text{V}$ and $R_L = 10\text{k}\Omega$, unless otherwise noted.

CMRR vs. Temperature

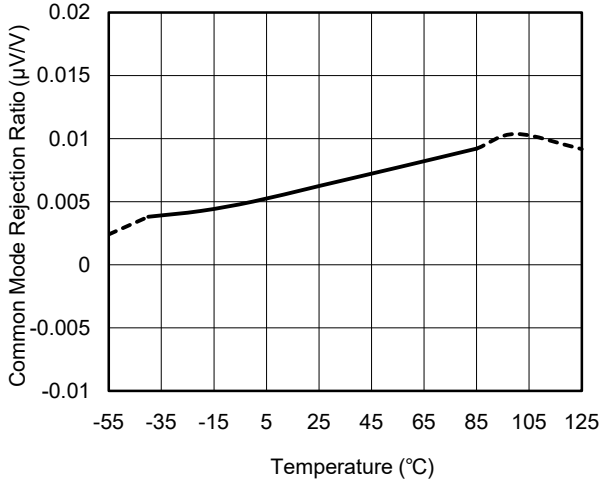

PSRR vs. Temperature

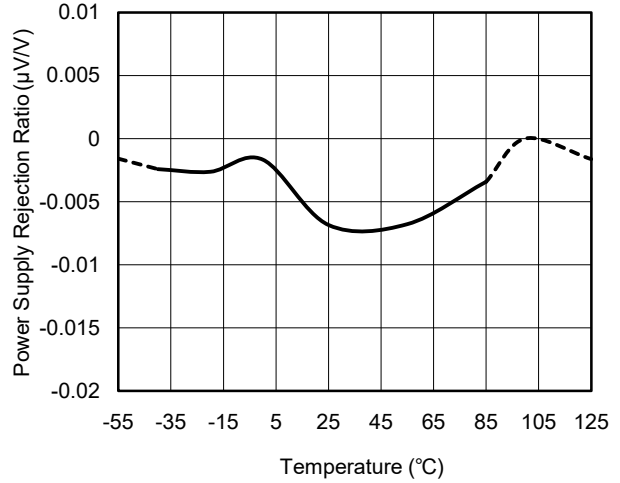

Open-Loop Gain vs. Temperature

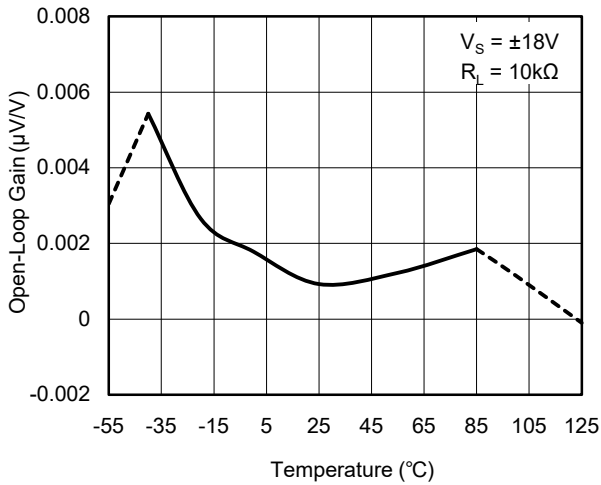

0.1Hz to 10Hz Input Voltage Noise

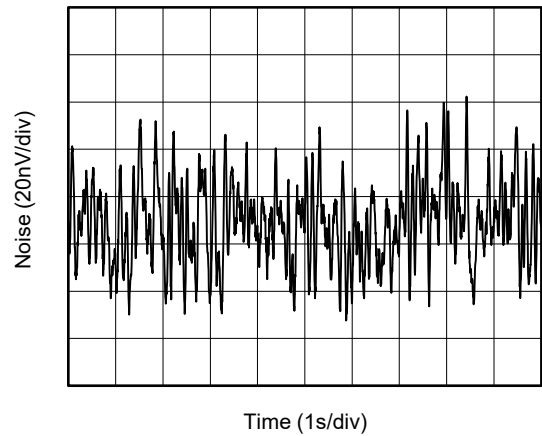

Closed-Loop Gain vs. Frequency

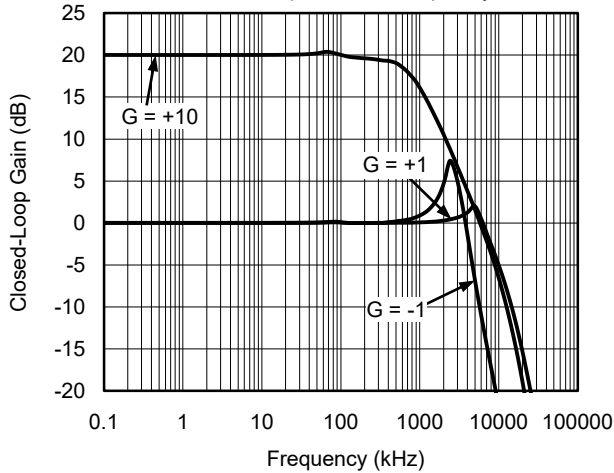

Input Voltage Noise Density (e_n) and Input Current Noise Density (i_n) vs. Frequency

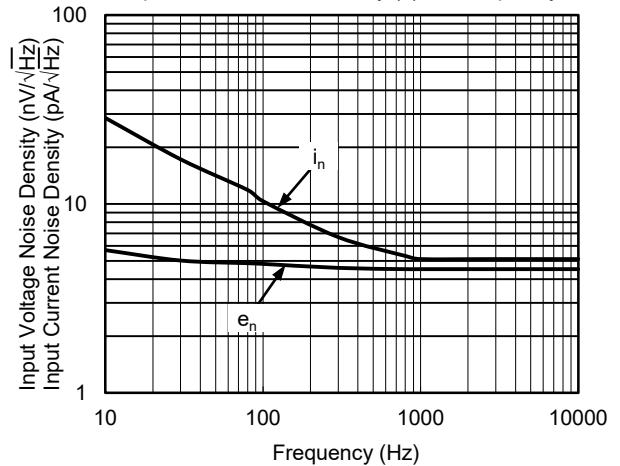

TYPICAL PERFORMANCE CHARACTERISTICS (continued)

At $T_A = +25^\circ\text{C}$, $V_S = \pm 18\text{V}$ and $R_L = 10\text{k}\Omega$, unless otherwise noted.

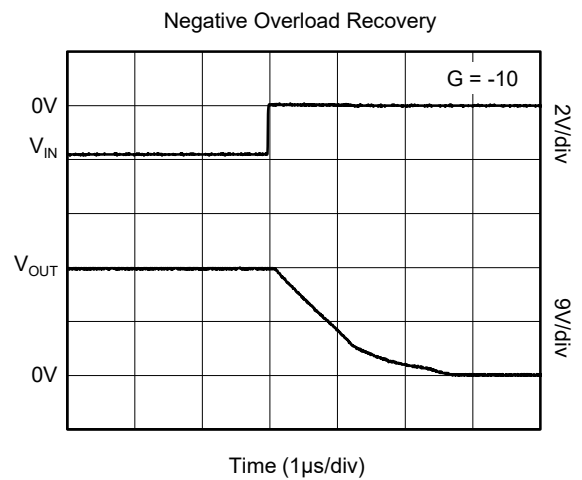
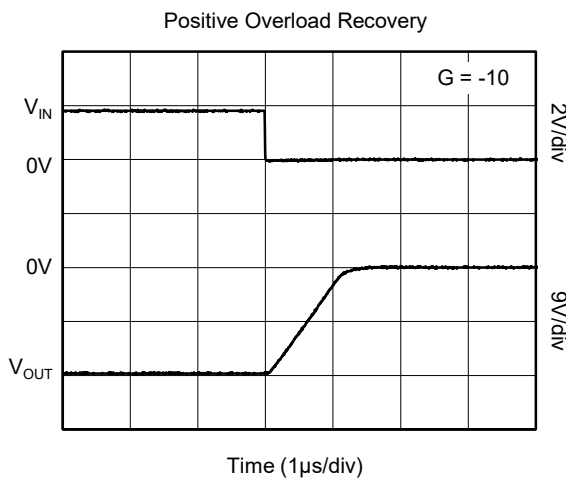
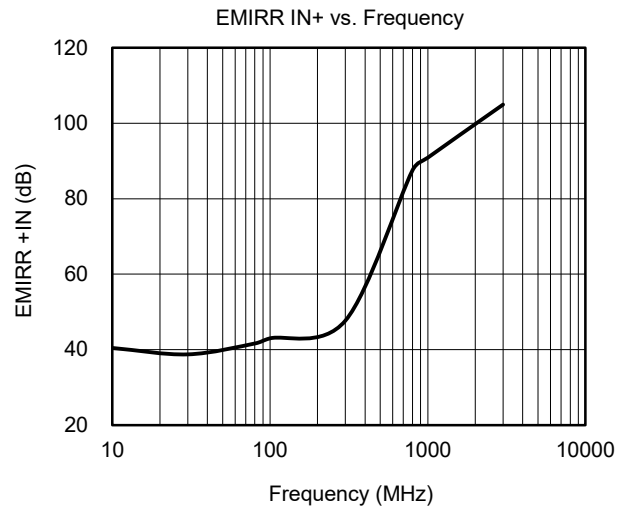
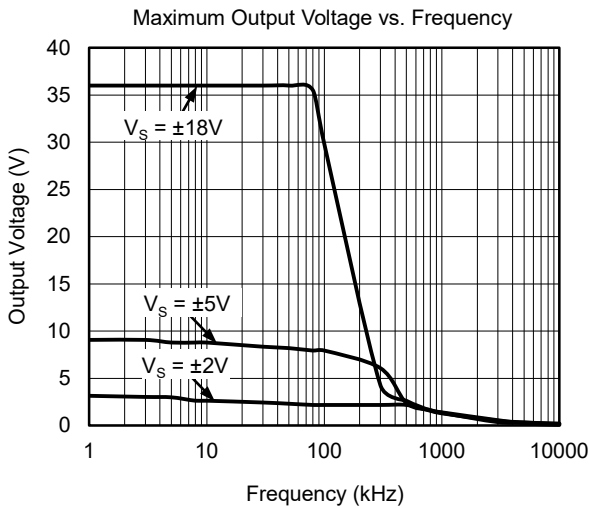
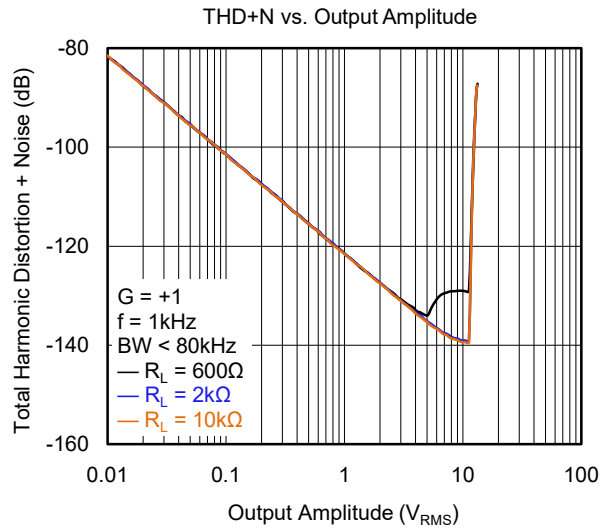
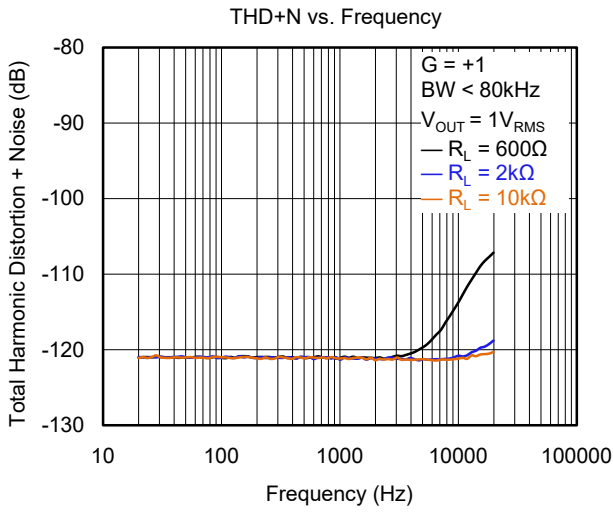

TYPICAL PERFORMANCE CHARACTERISTICS (continued)

At $T_A = +25^\circ\text{C}$, $V_S = \pm 18\text{V}$ and $R_L = 10\text{k}\Omega$, unless otherwise noted.

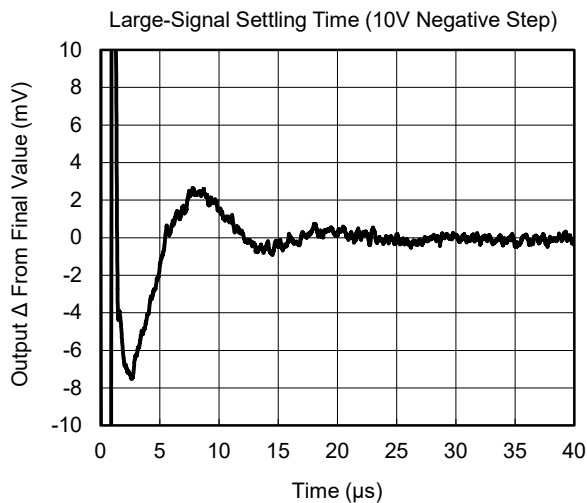
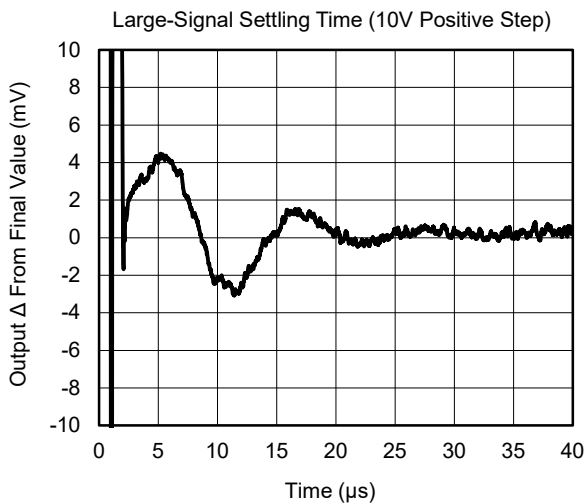
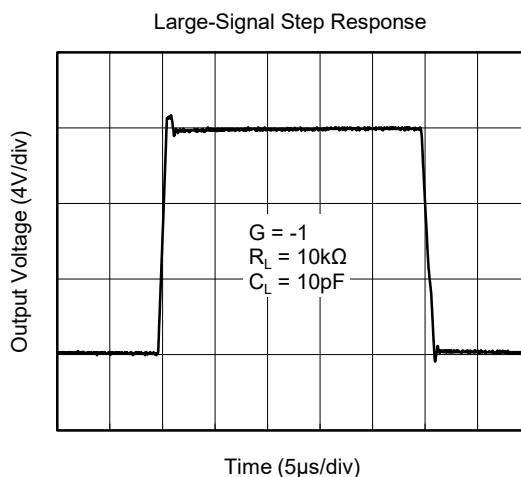
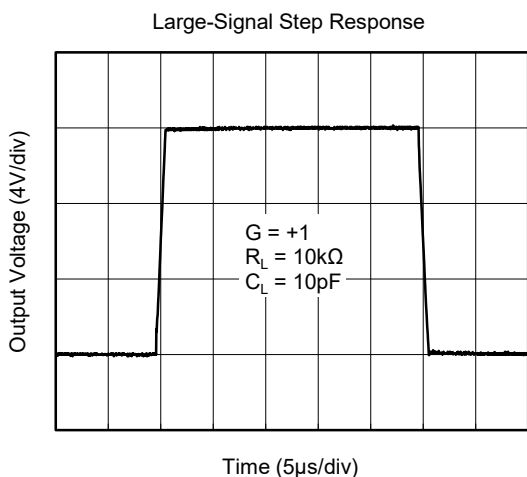
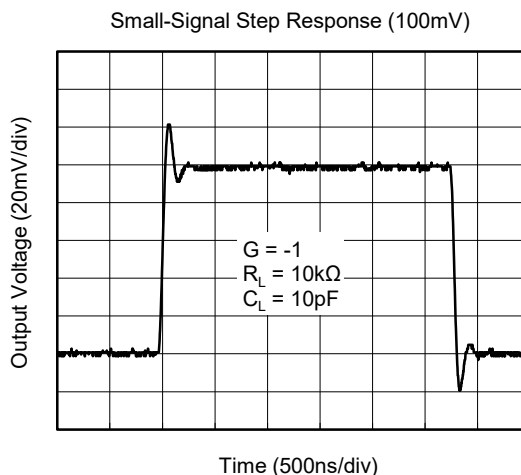
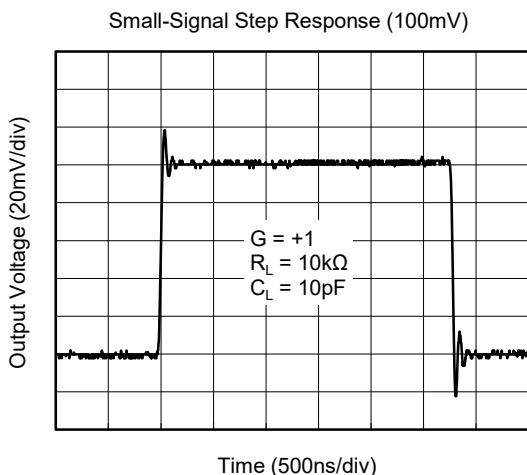

TYPICAL PERFORMANCE CHARACTERISTICS (continued)

At $T_A = +25^\circ\text{C}$, $V_S = \pm 18\text{V}$ and $R_L = 10\text{k}\Omega$, unless otherwise noted.

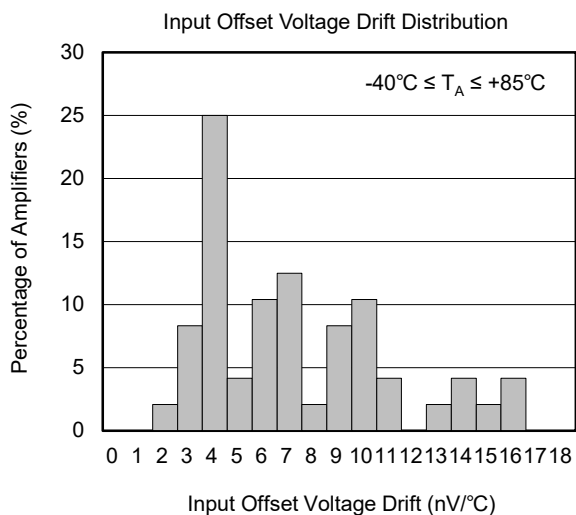
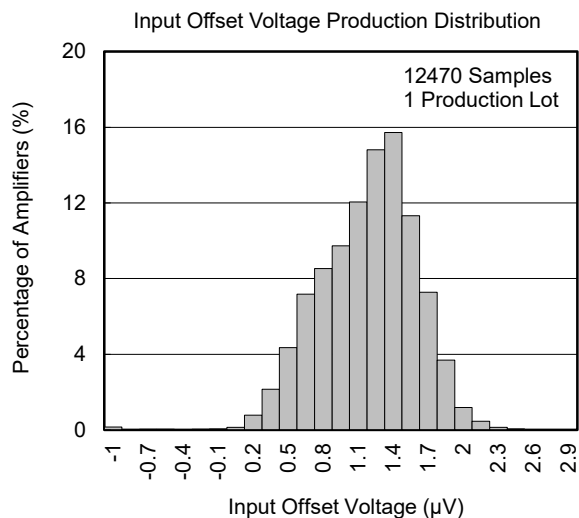
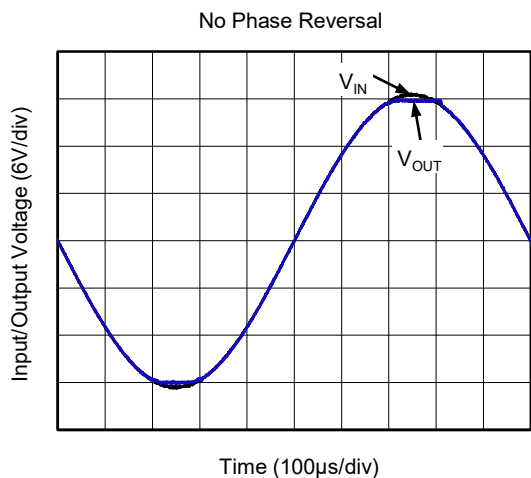

REVISION HISTORY

NOTE: Page numbers for previous revisions may differ from page numbers in the current version.

Changes from Original (DECEMBER 2017) to REV.A

Page

Changed from product preview to production data.....	All
--	-----

PACKAGE INFORMATION

PACKAGE OUTLINE DIMENSIONS

SOT-23-5

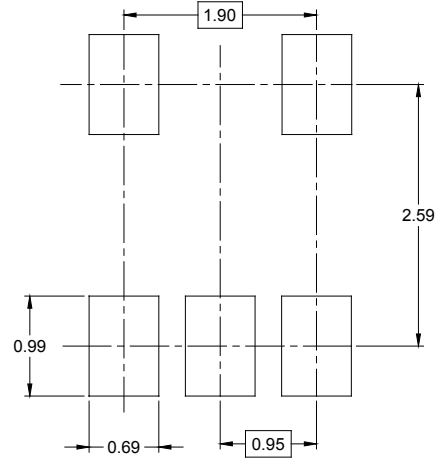
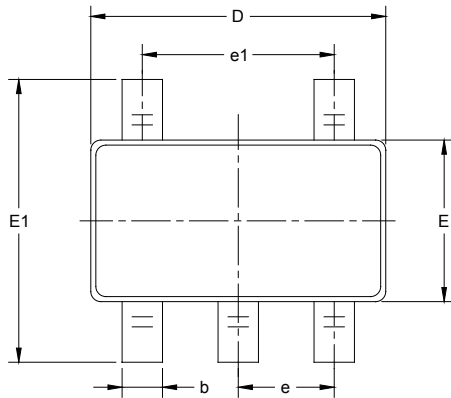

RECOMMENDED LAND PATTERN (Unit: mm)

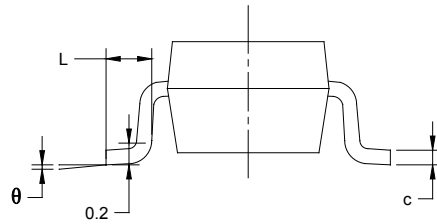
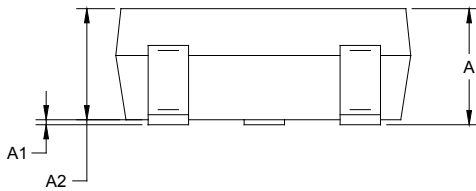

Symbol	Dimensions In Millimeters		Dimensions In Inches	
	MIN	MAX	MIN	MAX
A	1.050	1.250	0.041	0.049
A1	0.000	0.100	0.000	0.004
A2	1.050	1.150	0.041	0.045
b	0.300	0.500	0.012	0.020
c	0.100	0.200	0.004	0.008
D	2.820	3.020	0.111	0.119
E	1.500	1.700	0.059	0.067
E1	2.650	2.950	0.104	0.116
e	0.950 BSC		0.037 BSC	
e1	1.900 BSC		0.075 BSC	
L	0.300	0.600	0.012	0.024
θ	0°	8°	0°	8°

PACKAGE OUTLINE DIMENSIONS

SOIC-8

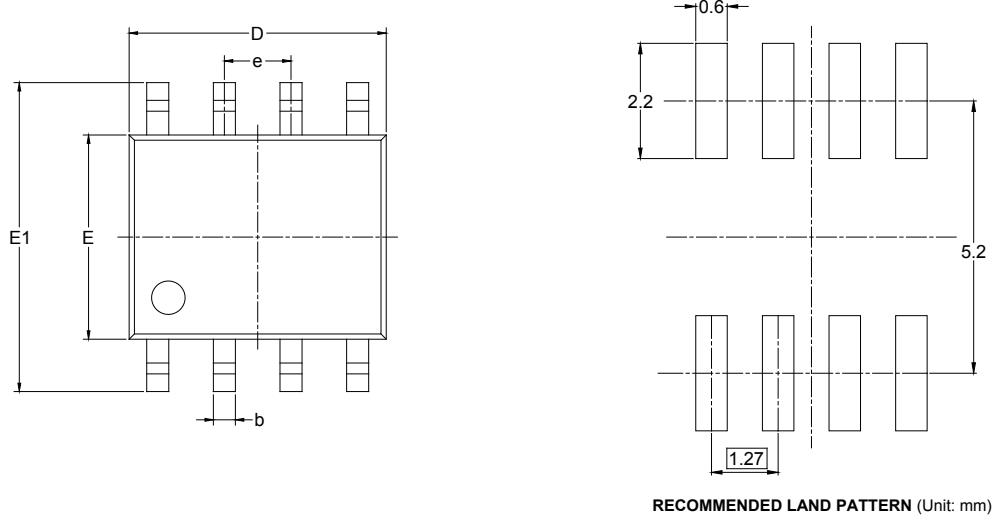

Symbol	Dimensions In Millimeters		Dimensions In Inches	
	MIN	MAX	MIN	MAX
A	1.350	1.750	0.053	0.069
A1	0.100	0.250	0.004	0.010
A2	1.350	1.550	0.053	0.061
b	0.330	0.510	0.013	0.020
c	0.170	0.250	0.006	0.010
D	4.700	5.100	0.185	0.200
E	3.800	4.000	0.150	0.157
E1	5.800	6.200	0.228	0.244
e	1.27 BSC		0.050 BSC	
L	0.400	1.270	0.016	0.050
θ	0°	8°	0°	8°

TAPE AND REEL INFORMATION

REEL DIMENSIONS



TAPE DIMENSIONS



NOTE: The picture is only for reference. Please make the object as the standard.

KEY PARAMETER LIST OF TAPE AND REEL

Package Type	Reel Diameter	Reel Width W1 (mm)	A0 (mm)	B0 (mm)	K0 (mm)	P0 (mm)	P1 (mm)	P2 (mm)	W (mm)	Pin1 Quadrant
SOT-23-5	7"	9.5	3.20	3.20	1.40	4.0	4.0	2.0	8.0	Q3
SOIC-8	13"	12.4	6.40	5.40	2.10	4.0	8.0	2.0	12.0	Q1

000001

PACKAGE INFORMATION

CARTON BOX DIMENSIONS



NOTE: The picture is only for reference. Please make the object as the standard.

KEY PARAMETER LIST OF CARTON BOX

Reel Type	Length (mm)	Width (mm)	Height (mm)	Pizza/Carton
7" (Option)	368	227	224	8
7"	442	410	224	18
13"	386	280	370	5

DD0002