



SGM811/SGM812 Microprocessor Supervisory Circuits with Manual Reset Input

GENERAL DESCRIPTION

The SGM811 and SGM812 are integrated microprocessor supervisory devices. The devices can be reset under power-up, power-down or even voltage reduction brownout conditions. When V_{CC} is as low as 1V, the reset output can still operate. On the power-on state, the internal timer maintains a 240ms reset assertion that keeps the microprocessor in the reset state until the condition is stable.

The SGM811 has an active-low nRESET output, while the SGM812 has an active-high nRESET output. All devices provide eight reset threshold voltage options for 1.8V, 2.5V, 3V, 3.3V and 5V voltage monitoring.

The devices also provide a manual reset (nMR) function. It can reduce damage that may be caused by loss of control or locking of the system.

The SGM811 and SGM812 are available in Green SOT-143 and SOT-23-5 packages. They operate over an ambient temperature range of -40°C to $+125^{\circ}\text{C}$.

FEATURES

- Superior Upgrade for MAX811/MAX812 and ADM811/ADM812
- High Accuracy Fixed Detection Options: 1.8V, 2.5V, 3V, 3.3V and 5V
- Low Current Consumption: 13 μA (TYP)
- 150ms (MIN) Power-On Reset
- Reset Output Options:
 - Active-Low nRESET Output: SGM811
 - Active-High RESET Output: SGM812
- Manual Reset Input
- Reset Assertion Down to 1V V_{CC}
- -40°C to $+125^{\circ}\text{C}$ Operating Temperature Range
- Available in Green SOT-143 and SOT-23-5 Packages

APPLICATIONS

Computers
Battery-Powered Applications
Portable Equipment
Automotive Equipment
Safety Systems
Intelligent Instruments
Critical μP Power Monitoring

TYPICAL APPLICATION

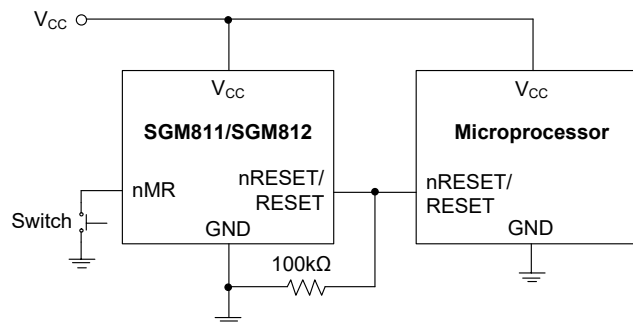

PACKAGE/ORDERING INFORMATION

ORDERING NUMBER	RESET THRESHOLD (V)	PACKAGE DESCRIPTION	SPECIFIED TEMPERATURE RANGE	PACKAGE MARKING	PACKING OPTION
SGM811-LXN5/TR	4.63	SOT-23-5	-40°C to +125°C	811L	Tape and Reel, 3000
SGM811-MXN5/TR	4.38	SOT-23-5	-40°C to +125°C	811M	Tape and Reel, 3000
SGM811-JXN5/TR	4.00	SOT-23-5	-40°C to +125°C	811J	Tape and Reel, 3000
SGM811-TXN5/TR	3.08	SOT-23-5	-40°C to +125°C	811T	Tape and Reel, 3000
SGM811-SXN5/TR	2.93	SOT-23-5	-40°C to +125°C	811S	Tape and Reel, 3000
SGM811-RXN5/TR	2.63	SOT-23-5	-40°C to +125°C	811R	Tape and Reel, 3000
SGM811-ZXN5/TR	2.32	SOT-23-5	-40°C to +125°C	811Z	Tape and Reel, 3000
SGM811-LXKA4/TR	4.63	SOT-143	-40°C to +125°C	811L	Tape and Reel, 3000
SGM811-MXKA4/TR	4.38	SOT-143	-40°C to +125°C	811M	Tape and Reel, 3000
SGM811-JXKA4/TR	4.00	SOT-143	-40°C to +125°C	811J	Tape and Reel, 3000
SGM811-TXKA4/TR	3.08	SOT-143	-40°C to +125°C	811T	Tape and Reel, 3000
SGM811-SXKA4/TR	2.93	SOT-143	-40°C to +125°C	811S	Tape and Reel, 3000
SGM811-RXKA4/TR	2.63	SOT-143	-40°C to +125°C	811R	Tape and Reel, 3000
SGM811-ZXKA4/TR	2.32	SOT-143	-40°C to +125°C	811Z	Tape and Reel, 3000
SGM811-XXKA4/TR	1.63	SOT-143	-40°C to +125°C	811X	Tape and Reel, 3000
SGM812-LXN5/TR	4.63	SOT-23-5	-40°C to +125°C	812L	Tape and Reel, 3000
SGM812-MXN5/TR	4.38	SOT-23-5	-40°C to +125°C	812M	Tape and Reel, 3000
SGM812-JXN5/TR	4.00	SOT-23-5	-40°C to +125°C	812J	Tape and Reel, 3000
SGM812-TXN5/TR	3.08	SOT-23-5	-40°C to +125°C	812T	Tape and Reel, 3000
SGM812-SXN5/TR	2.93	SOT-23-5	-40°C to +125°C	812S	Tape and Reel, 3000
SGM812-RXN5/TR	2.63	SOT-23-5	-40°C to +125°C	812R	Tape and Reel, 3000
SGM812-ZXN5/TR	2.32	SOT-23-5	-40°C to +125°C	812Z	Tape and Reel, 3000
SGM812-LXKA4/TR	4.63	SOT-143	-40°C to +125°C	812L	Tape and Reel, 3000
SGM812-MXKA4/TR	4.38	SOT-143	-40°C to +125°C	812M	Tape and Reel, 3000
SGM812-JXKA4/TR	4.00	SOT-143	-40°C to +125°C	812J	Tape and Reel, 3000
SGM812-TXKA4/TR	3.08	SOT-143	-40°C to +125°C	812T	Tape and Reel, 3000
SGM812-SXKA4/TR	2.93	SOT-143	-40°C to +125°C	812S	Tape and Reel, 3000
SGM812-RXKA4/TR	2.63	SOT-143	-40°C to +125°C	812R	Tape and Reel, 3000
SGM812-ZXKA4/TR	2.32	SOT-143	-40°C to +125°C	812Z	Tape and Reel, 3000

Green (RoHS & HSF): SG Micro Corp defines "Green" to mean Pb-Free (RoHS compatible) and free of halogen substances. If you have additional comments or questions, please contact your SGMICRO representative directly.

ABSOLUTE MAXIMUM RATINGS

(Typical values are at $T_A = +25^\circ\text{C}$, unless otherwise noted.)
Terminal Voltage (With Respect to Ground)

V_{CC}	-0.3V to 6V
All Other Inputs.....	-0.3V to $V_{CC} + 0.3V$
Input Current	
V_{CC} , nMR.....	20mA
Output Current	
RESET, nRESET.....	20mA
Power Dissipation, $P_D @ T_A = +25^\circ\text{C}$	
SOT-23-5.....	0.4W
SOT-143.....	0.32W
Operating Temperature Range.....	-40°C to $+125^\circ\text{C}$
Junction Temperature.....	$+150^\circ\text{C}$
Storage Temperature Range.....	-65°C to $+150^\circ\text{C}$
Lead Temperature (Soldering, 10s).....	$+260^\circ\text{C}$
ESD Susceptibility	
HBM.....	4000V
MM.....	400V

OVERSTRESS CAUTION

Stresses beyond those listed in Absolute Maximum Ratings may cause permanent damage to the device. Exposure to absolute maximum rating conditions for extended periods may affect reliability. Functional operation of the device at any conditions beyond those indicated in the Recommended Operating Conditions section is not implied.

ESD SENSITIVITY CAUTION

This integrated circuit can be damaged if ESD protections are not considered carefully. SGMICRO recommends that all integrated circuits be handled with appropriate precautions. Failure to observe proper handling and installation procedures can cause damage. ESD damage can range from subtle performance degradation to complete device failure. Precision integrated circuits may be more susceptible to damage because even small parametric changes could cause the device not to meet the published specifications.

DISCLAIMER

SG Micro Corp reserves the right to make any change in circuit design, or specifications without prior notice.

PIN CONFIGURATIONS

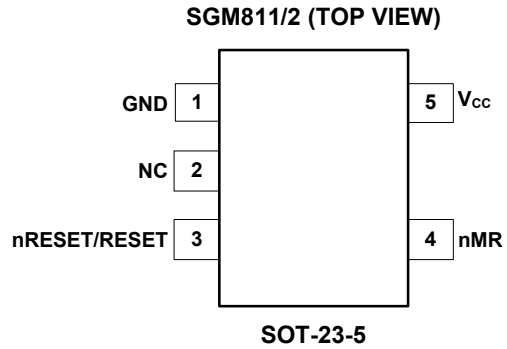
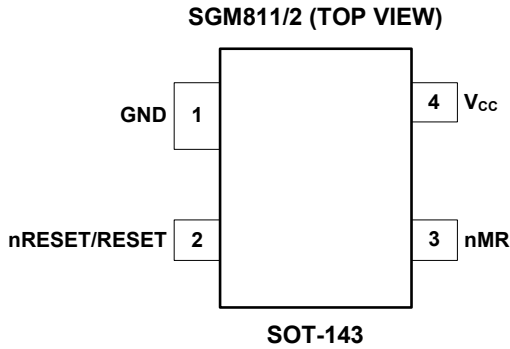

PIN DESCRIPTION

NAME	PIN NUMBER				FUNCTION
	SGM811		SGM812		
	SOT-143	SOT-23-5	SOT-143	SOT-23-5	
GND	1	1	1	1	Ground Pin.
NC	—	2	—	2	Not Connected.
nRESET	2	3	—	—	Active-Low Reset Output Pin. nRESET remains low if V _{CC} is below the reset threshold or nMR is logic low. It goes (or remains) low for 240ms (TYP) after V _{CC} rises above the reset threshold or the nMR input goes from low to high.
RESET	—	—	2	3	Active-High Reset Output Pin. It is the inverse of nRESET.
nMR	3	4	3	4	Manual Reset Input Pin. It is an active-low reset input, guaranteed to accept input pulses of more than 10μs, and ignore input pulses of 100ns or less. If not used, leave it open or connect it to V _{CC} .
V _{CC}	4	5	4	5	Supply Voltage Pin.

ELECTRICAL CHARACTERISTICS

(V_{CC} = 5V for L/M/J Models, 3.3V for T/S Models, 3V for R Model, 2.5V for Z Model, 1.8V for X Model, unless otherwise noted.)

PARAMETER	CONDITIONS	MIN	TYP	MAX	UNITS
SUPPLY					
Voltage	T _A = 0°C to +70°C	1.0		5.5	V
	T _A = -40°C to +125°C	1.2		5.5	V
Current	V _{CC} < 5.5V, SGM81_L/M/J, T _A = +25°C		17	30	μA
	V _{CC} < 5.5V, SGM81_L/M/J, T _A = -40°C to +125°C			50	μA
	V _{CC} < 3.6V, SGM81_R/S/T/Z/X, T _A = +25°C		13	25	μA
	V _{CC} < 3.6V, SGM81_R/S/T/Z/X, T _A = -40°C to +125°C			45	μA
RESET VOLTAGE THRESHOLD					
SGM81_L	T _A = +25°C	4.537	4.63	4.723	V
	T _A = -40°C to +125°C	4.40		4.86	V
SGM81_M	T _A = +25°C	4.292	4.38	4.468	V
	T _A = -40°C to +125°C	4.16		4.56	V
SGM81_J	T _A = +25°C	3.92	4.00	4.08	V
	T _A = -40°C to +125°C	3.8		4.2	V
SGM81_T	T _A = +25°C	3.003	3.08	3.157	V
	T _A = -40°C to +125°C	2.92		3.23	V
SGM81_S	T _A = +25°C	2.857	2.93	3.003	V
	T _A = -40°C to +125°C	2.78		3.08	V
SGM81_R	T _A = +25°C	2.564	2.63	2.696	V
	T _A = -40°C to +125°C	2.50		2.76	V
SGM81_Z	T _A = +25°C	2.262	2.32	2.378	V
	T _A = -40°C to +125°C	2.22		2.42	V
SGM811-X	T _A = +25°C	1.589	1.63	1.671	V
	T _A = -40°C to +125°C	1.55		1.71	V
Reset Threshold Temperature Coefficient			30		ppm/°C
V _{CC} to RESET/nRESET Delay	V _{CC} = V _{TH} to (V _{TH} - 100mV)		20		μs
Reset Active Timeout Period	T _A = -40°C to +85°C	150	240	560	ms
	T _A = -40°C to +125°C	100		840	ms
MANUAL RESET					
Minimum Pulse Width		10			μs
Glitch Immunity			100		ns
RESET/nRESET Propagation Delay			0.5		μs
Pull-Up Resistance			1		MΩ
The Manual Reset Circuit Will Act On:					
An Input Rising Above	V _{CC} > V _{TH(MAX)} , SGM81_L/M/J	2.3			V
An Input Falling Below	V _{CC} > V _{TH(MAX)} , SGM81_L/M/J			0.8	V
An Input Rising Above	V _{CC} > V _{TH(MAX)} , SGM81_R/S/T/Z/X	0.7 × V _{CC}			V
An Input Falling Below	V _{CC} > V _{TH(MAX)} , SGM81_R/S/T/Z/X			0.25 × V _{CC}	V

ELECTRICAL CHARACTERISTICS (continued)

($V_{CC} = 5V$ for L/M/J Models, $3.3V$ for T/S Models, $3V$ for R Model, $2.5V$ for Z Model, $1.8V$ for X Model, unless otherwise noted.)

PARAMETER	CONDITIONS	MIN	TYP	MAX	UNITS
RESET/nRESET OUTPUT VOLTAGE					
Low (SGM811-R/S/T/Z/X)	$V_{CC} = V_{TH(MIN)}$, $I_{SINK} = 1.2mA$			0.3	V
Low (SGM811-L/M/J)	$V_{CC} = V_{TH(MIN)}$, $I_{SINK} = 3.2mA$			0.4	V
Low (SGM811-R/S/T/Z/X/L/M/J)	$V_{CC} > 1.0V$, $I_{SINK} = 50\mu A$			0.3	V
High (SGM811-R/S/T/Z/X)	$V_{CC} > V_{TH(MAX)}$, $I_{SOURCE} = 500\mu A$	$0.8 \times V_{CC}$			V
High (SGM811-L/M/J)	$V_{CC} > V_{TH(MAX)}$, $I_{SOURCE} = 800\mu A$	$V_{CC} - 1.5$			V
Low (SGM812-R/S/T/Z/X)	$V_{CC} = V_{TH(MAX)}$, $I_{SINK} = 1.2mA$			0.3	V
Low (SGM812-L/M/J)	$V_{CC} = V_{TH(MAX)}$, $I_{SINK} = 3.2mA$			0.4	V
High (SGM812-R/S/T/Z/X/L/M/J)	$1.8V < V_{CC} < V_{TH(MIN)}$, $I_{SOURCE} = 150\mu A$	$0.8 \times V_{CC}$			V

TYPICAL PERFORMANCE CHARACTERISTICS

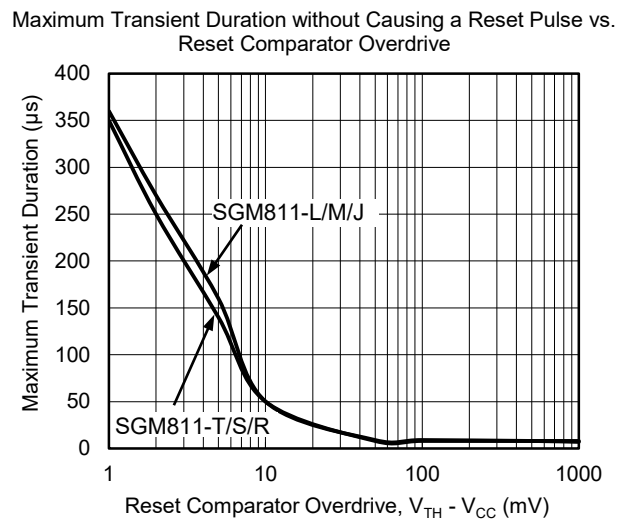
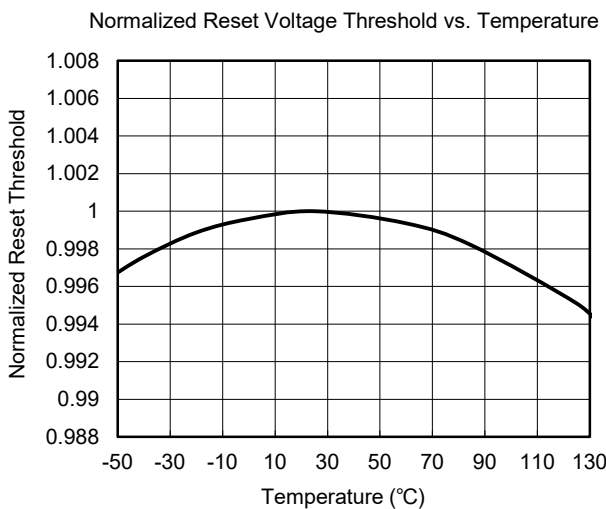
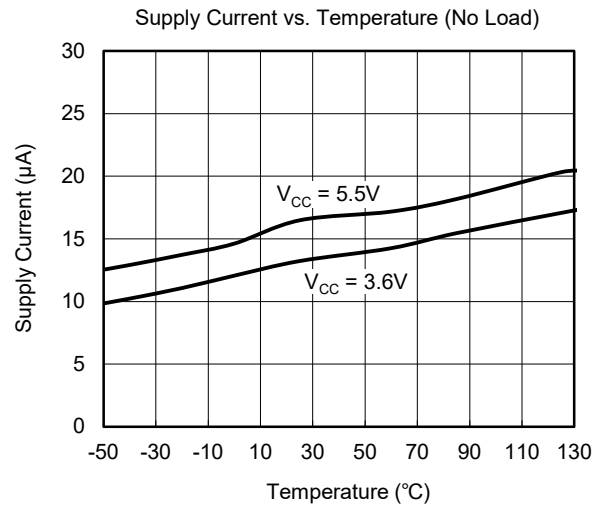
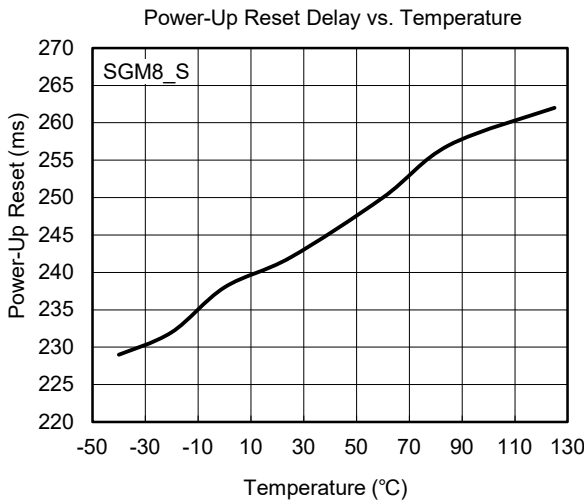
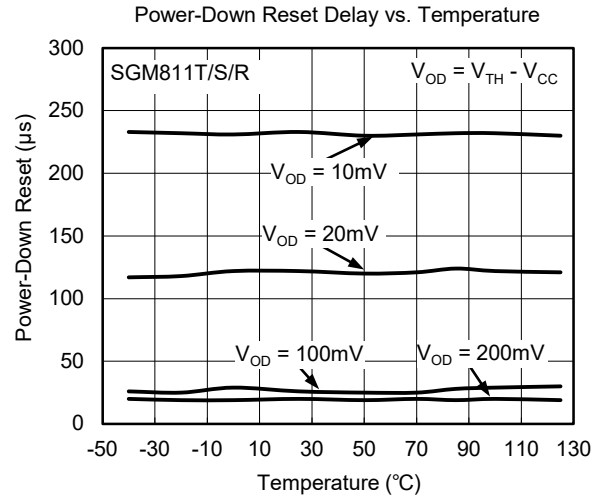
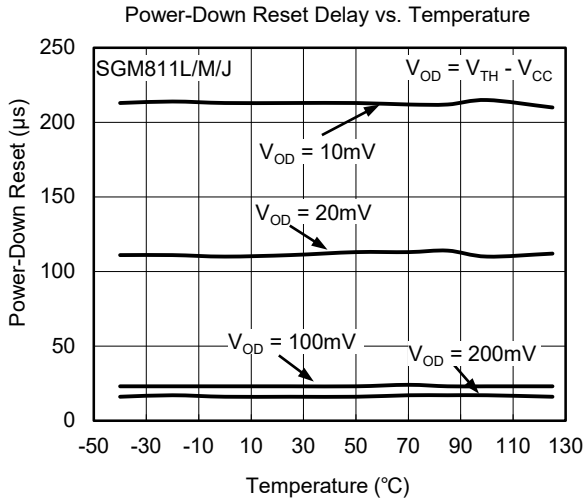

TYPICAL PERFORMANCE CHARACTERISTICS (continued)

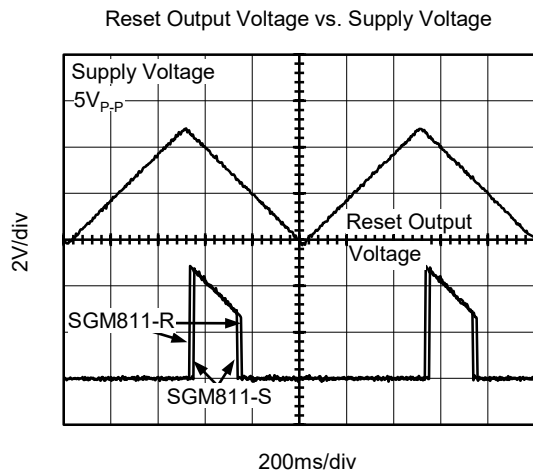

REVISION HISTORY

NOTE: Page numbers for previous revisions may differ from page numbers in the current version.

JANUARY 2015 – REV.B.3 to REV.B.4

Added SGM811-1.63 Option.....All

JANUARY 2013 – REV.B.2 to REV.B.3

Added Recommended Land Pattern Information 10, 11

Added Tape and Reel Information 12, 13

PACKAGE OUTLINE DIMENSIONS

SOT-143

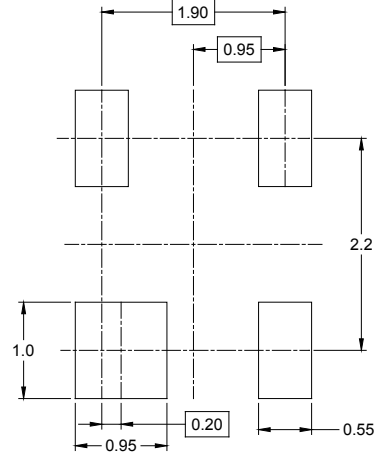
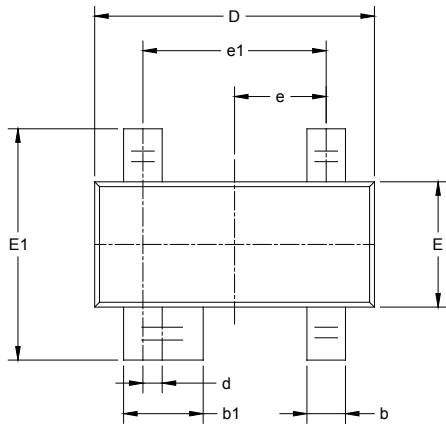

RECOMMENDED LAND PATTERN (Unit: mm)

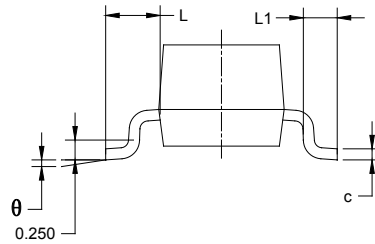
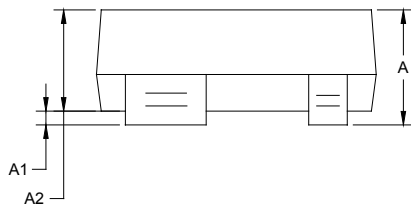

Symbol	Dimensions In Millimeters		Dimensions In Inches	
	MIN	MAX	MIN	MAX
A	0.900	1.150	0.035	0.045
A1	0.000	0.100	0.000	0.004
A2	0.900	1.050	0.035	0.041
b	0.300	0.500	0.012	0.020
b1	0.750	0.900	0.030	0.035
c	0.080	0.150	0.003	0.006
D	2.800	3.000	0.110	0.118
d	0.200 TYP		0.008 TYP	
E	1.200	1.400	0.047	0.055
E1	2.250	2.550	0.089	0.100
e	0.95 TYP		0.037 TYP	
e1	1.800	2.000	0.071	0.079
L	0.55 REF		0.022 REF	
L1	0.300	0.500	0.012	0.020
θ	0°	8°	0°	8°

PACKAGE OUTLINE DIMENSIONS

SOT-23-5



RECOMMENDED LAND PATTERN (Unit: mm)



Symbol	Dimensions In Millimeters		Dimensions In Inches	
	MIN	MAX	MIN	MAX
A	1.050	1.250	0.041	0.049
A1	0.000	0.100	0.000	0.004
A2	1.050	1.150	0.041	0.045
b	0.300	0.500	0.012	0.020
c	0.100	0.200	0.004	0.008
D	2.820	3.020	0.111	0.119
E	1.500	1.700	0.059	0.067
E1	2.650	2.950	0.104	0.116
e	0.950 BSC		0.037 BSC	
e1	1.900 BSC		0.075 BSC	
L	0.300	0.600	0.012	0.024
θ	0°	8°	0°	8°

TAPE AND REEL INFORMATION

REEL DIMENSIONS



TAPE DIMENSIONS



NOTE: The picture is only for reference. Please make the object as the standard.

KEY PARAMETER LIST OF TAPE AND REEL

Package Type	Reel Diameter	Reel Width W1 (mm)	A0 (mm)	B0 (mm)	K0 (mm)	P0 (mm)	P1 (mm)	P2 (mm)	W (mm)	Pin1 Quadrant
SOT-143	7"	9.5	3.20	2.80	1.30	4.0	4.0	2.0	8.0	Q3
SOT-23-5	7"	9.5	3.20	3.20	1.40	4.0	4.0	2.0	8.0	Q3

D00001

PACKAGE INFORMATION

CARTON BOX DIMENSIONS



NOTE: The picture is only for reference. Please make the object as the standard.

KEY PARAMETER LIST OF CARTON BOX

Reel Type	Length (mm)	Width (mm)	Height (mm)	Pizza/Carton
7" (Option)	368	227	224	8
7"	442	410	224	18

DD0002