

GENERAL DESCRIPTION

The SGM66055 is an internally compensated, 2.2MHz switching frequency, peak current mode, synchronous Boost switching converter. Even below the minimum system battery voltage, the device maintains the output voltage regulation for a minimum output load current of 0.9A. This device turns into power-saving mode to maintain high efficiency by lowering switching frequency. With its anti-ringing circuitry damping the charge in parasitic capacitor, it reduces EMI interference significantly. Its output is disconnected by the rectifier circuit during shutdown with no input to output leakage.

The SGM66055-4.5/5.4 are available in the Green WLCSP-1.21×1.21-9B package; the SGM66055-5.0 is available in the Green WLCSP-1.21×1.21-9B and TDFN-2×3-8BL packages.

FEATURES

- **Operating Input Voltage Range: 2.5V to 4.5V**
- **Fixed Output Voltages: 4.5V, 5.0V and 5.4V**
- **Output Voltage Clamping: 5.7V**
- **Up to 93% Efficiency**
- **Quiescent Current: 23µA (TYP)**
- **Shutdown Current: 1µA (MAX)**
- **Improved Light Load Efficiency with Power-Save Mode (PSM)**
- **Load Disconnect During Shutdown**
- **Low Reverse Leakage Current when $V_{OUT} > V_{IN}$**
- **Thermal Shutdown**
- **-40°C to +85°C Operating Temperature Range**
- **Available in Green WLCSP-1.21×1.21-9B and TDFN-2×3-8BL Packages**

APPLICATIONS

- USB OTG
- Class-D Audio Amplifier
- Smart Phones and Tablets
- Portable and Wearable Devices

TYPICAL APPLICATION

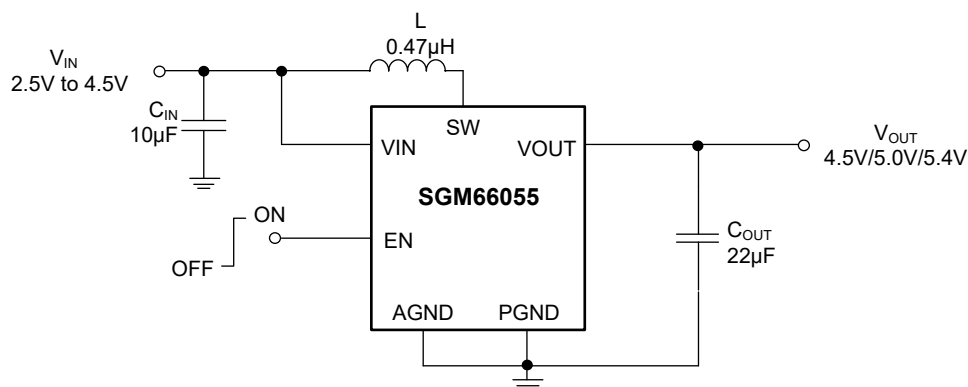

Figure 1. Typical Application Circuit

PACKAGE/ORDERING INFORMATION

MODEL	V _{OUT} (V)	PACKAGE DESCRIPTION	SPECIFIED TEMPERATURE RANGE	ORDERING NUMBER	PACKAGE MARKING	PACKING OPTION
SGM66055	4.5	WLCSP-1.21×1.21-9B	-40°C to +85°C	SGM66055-4.5YG/TR	M9E XXXX	Tape and Reel, 3000
	5.0	WLCSP-1.21×1.21-9B	-40°C to +85°C	SGM66055-5.0YG/TR	GW6 XXXX	Tape and Reel, 3000
	5.4	WLCSP-1.21×1.21-9B	-40°C to +85°C	SGM66055-5.4YG/TR	GW7 XXXX	Tape and Reel, 3000
	5.0	TDFN-2×3-8BL	-40°C to +85°C	SGM66055-5.0YTDC8G/TR	MC3 XXXX	Tape and Reel, 3000

MARKING INFORMATION

WLCSP-1.21×1.21-9B

(1) XXXX = Date Code.

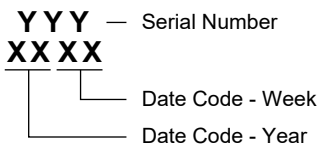

TDFN-2×3-8BL

(3) XXXX = Date Code and Trace Code.

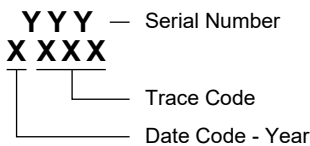

SGM66055-5.0: WLCSP-1.21×1.21-9B

(2) XXXX = Date Code and Trace Code.

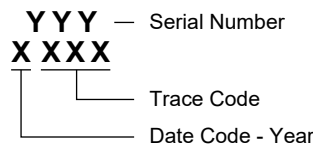

Green (RoHS & HSF): SG Micro Corp defines "Green" to mean Pb-Free (RoHS compatible) and free of halogen substances. If you have additional comments or questions, please contact your SGMICRO representative directly.

ABSOLUTE MAXIMUM RATINGS

Voltage on VIN Pin	-0.3V to 5.5V
Voltage on VOUT Pin	6V
SW Node (DC).....	-0.3V to 6V
SW Node (Transient: 10ns, 3MHz).....	-1V to 8V
Voltage on Other Pins.....	-0.3V to 6V
Package Thermal Resistance	
WLCSP-1.21×1.21-9B, θ _{JA}	90°C/W
TDFN-2×3-8BL, θ _{JA}	85°C/W
Junction Temperature.....	+150°C
Storage Temperature Range	-65°C to +150°C
Lead Temperature (Soldering, 10s).....	+260°C
ESD Susceptibility	
HBM.....	4000V
MM.....	400V
CDM	1000V

OVERSTRESS CAUTION

Stresses beyond those listed in Absolute Maximum Ratings may cause permanent damage to the device. Exposure to absolute maximum rating conditions for extended periods may affect reliability. Functional operation of the device at any conditions beyond those indicated in the Recommended Operating Conditions section is not implied.

ESD SENSITIVITY CAUTION

This integrated circuit can be damaged by ESD if you don't pay attention to ESD protection. SGMICRO recommends that all integrated circuits be handled with appropriate precautions. Failure to observe proper handling and installation procedures can cause damage. ESD damage can range from subtle performance degradation to complete device failure. Precision integrated circuits may be more susceptible to damage because very small parametric changes could cause the device not to meet its published specifications.

DISCLAIMER

SG Micro Corp reserves the right to make any change in circuit design, or specifications without prior notice.

PIN CONFIGURATIONS

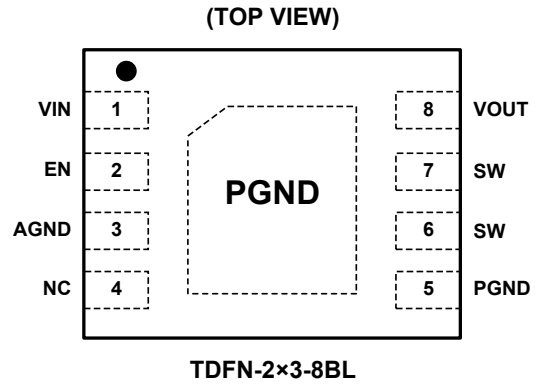
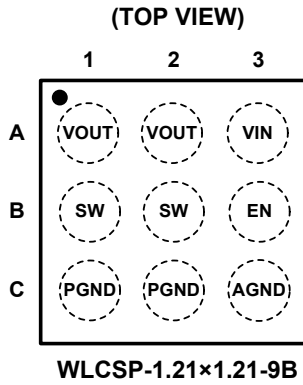

PIN DESCRIPTION

WLCSP-1.21×1.21-9B	TDFN-2×3-8BL	NAME	FUNCTION
A1, A2	8	VOUT	Boost Converter Output.
A3	1	VIN	Power Supply Input.
B1, B2	6, 7	SW	Switching Node. SW connects to an inductor.
B3	2	EN	Device Enable Node. Input logic high to enable this circuit.
C1, C2	5	PGND	Power Ground.
C3	3	AGND	Analog Ground.
—	4	NC	No Connection.
—	Exposed Pad	PGND	Exposed Pad. Internally connects to PGND.

ELECTRICAL CHARACTERISTICS(V_{IN} = 3.6V, Full = -40°C to +85°C, typical values are at T_A = +25°C, unless otherwise noted.)

PARAMETER	SYMBOL	CONDITIONS	TEMP	MIN	TYP	MAX	UNITS	
DC/DC Stage								
Input Voltage Range	V _{IN}		+25°C	2.5		4.5	V	
Switching Frequency	f _{SW}		Full	1.80	2.20	2.55	MHz	
Switch Current Limit	I _L	SGM66055-4.5/5.0	+25°C	3.3	4.2	4.8	A	
		SGM66055-5.4	+25°C	2.1	3.0	3.6		
Start-up Current Limit			+25°C		700		mA	
Boost Switch On-Resistance		V _{OUT} = 5.0V	WLCSP	+25°C		50	65	mΩ
			TDFN	+25°C		85	105	
Rectifying Switch On-Resistance		V _{OUT} = 5.0V	WLCSP	+25°C		60	80	mΩ
			TDFN	+25°C		95	115	
Output Voltage	V _{OUT}	SGM66055-4.5	Full	4.40	4.50	4.64	V	
		SGM66055-5.0	Full	4.89	5.00	5.15		
		SGM66055-5.4	Full	5.30	5.40	5.56		
Line Regulation		V _{IN} = 2.5V to V _{OUT} - 0.5V	+25°C		0.1		%	
Load Regulation			+25°C		0.2		%	
Quiescent Current	I _Q	V _{EN} = V _{IN} = 3.6V, not switching	+25°C		23	33	μA	
Shutdown Current	I _{SD}	V _{EN} = 0V, V _{IN} = 3.6V	+25°C			1	μA	
Control Stage								
EN Input Low Voltage	V _{IL}		Full			0.4	V	
EN Input High Voltage	V _{IH}		Full	1.3			V	
EN Input Current	I _{EN}	Clamped on GND or VIN	Full	-1		1	μA	
Thermal Shutdown	T _{SD}				150		°C	
Thermal Shutdown Hysteresis	T _{SD_HYS}				20		°C	

TYPICAL PERFORMANCE CHARACTERISTICS

At $T_A = +25^\circ\text{C}$, $V_{IN} = 3.6\text{V}$, $C_{IN} = 10\mu\text{F}$, $C_{OUT} = 20\mu\text{F}$, unless otherwise noted.

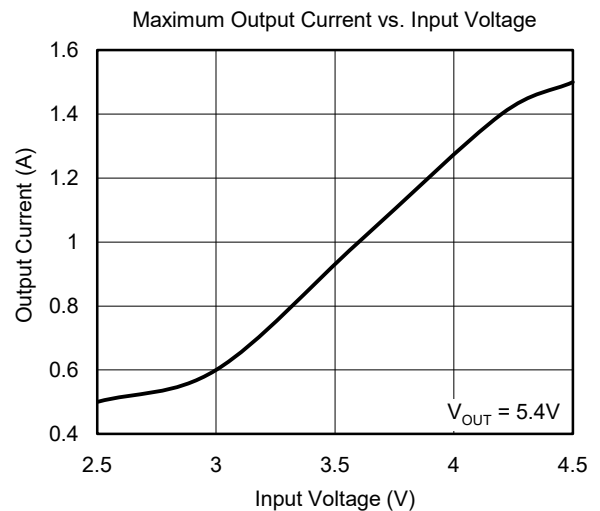
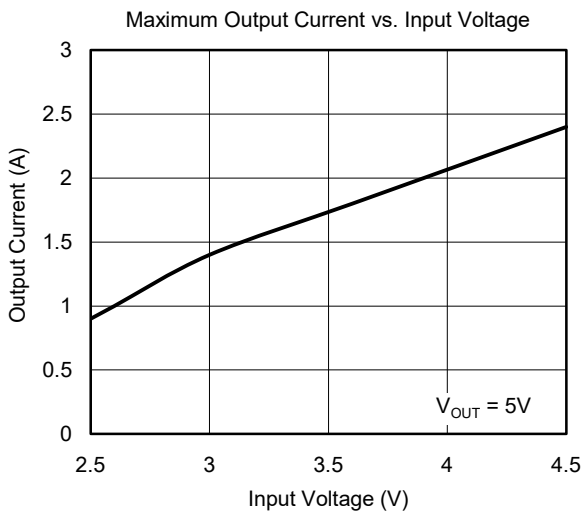
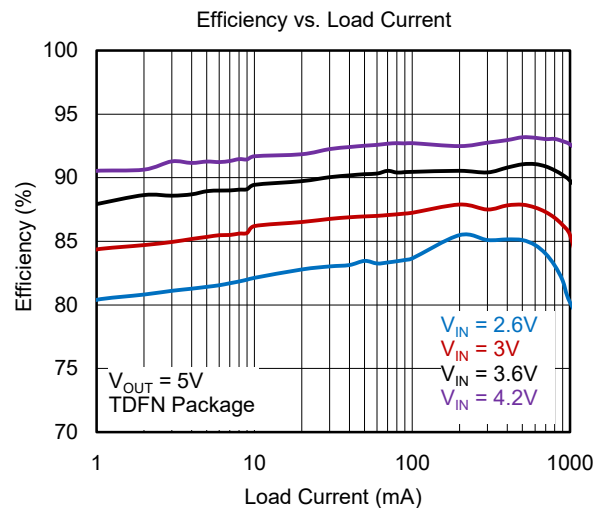
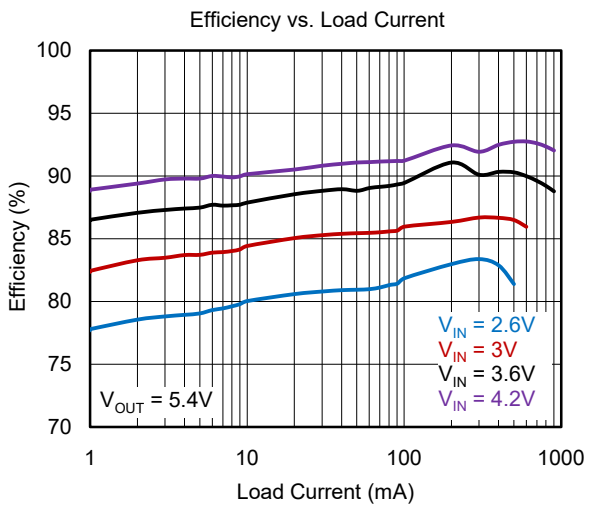
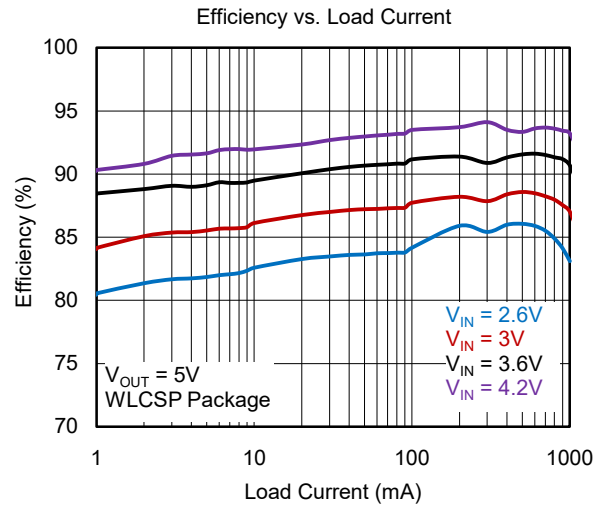
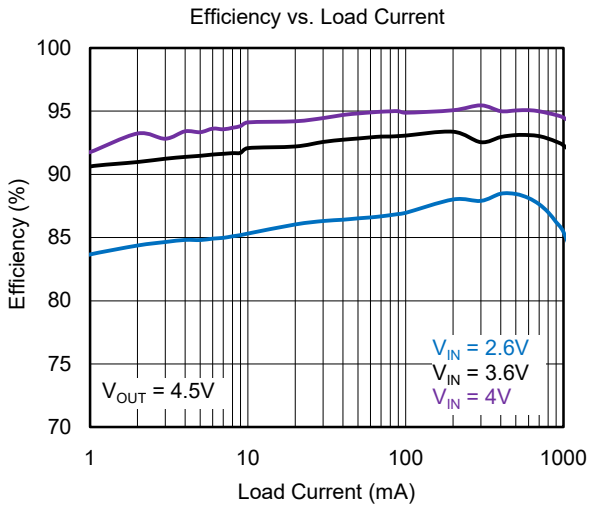

TYPICAL PERFORMANCE CHARACTERISTICS (continued)

At $T_A = +25^\circ\text{C}$, $V_{IN} = 3.6\text{V}$, $C_{IN} = 10\mu\text{F}$, $C_{OUT} = 20\mu\text{F}$, unless otherwise noted.

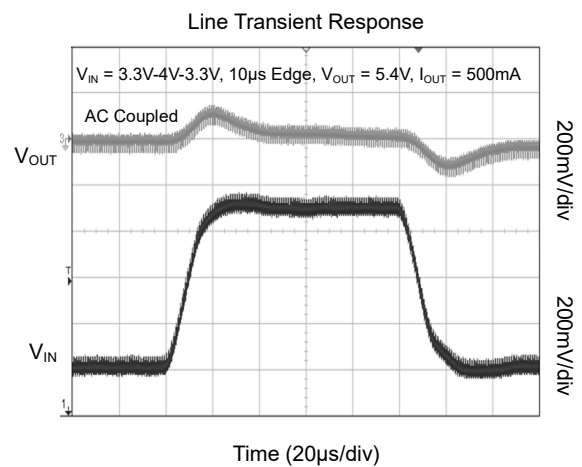
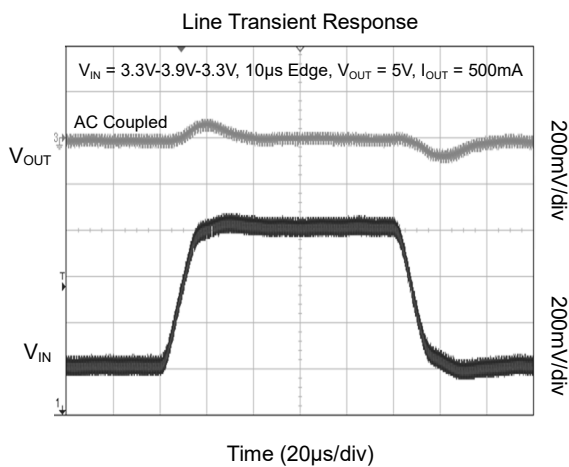
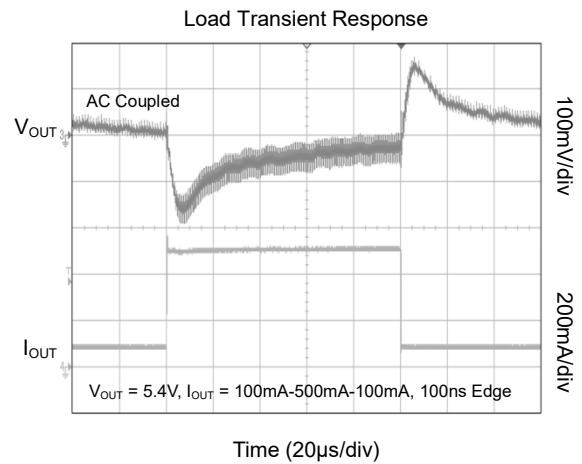
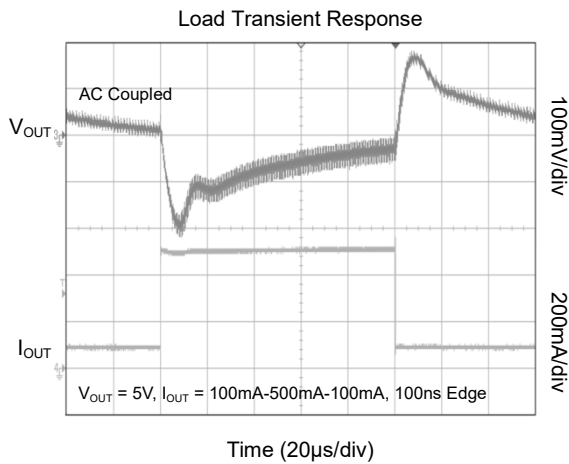
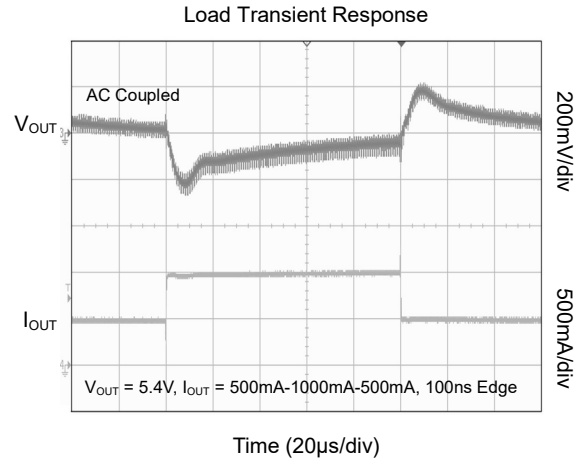
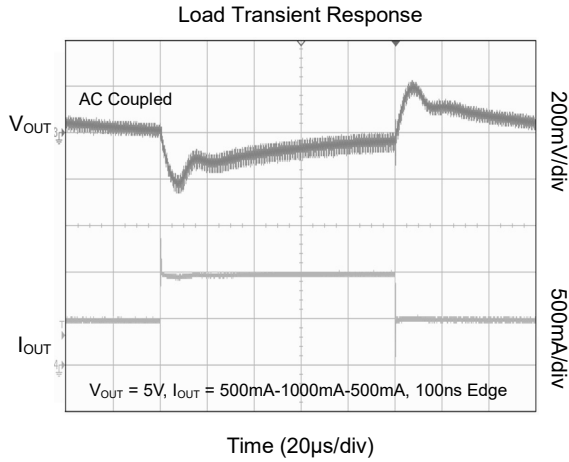

TYPICAL PERFORMANCE CHARACTERISTICS (continued)

At $T_A = +25^\circ\text{C}$, $V_{IN} = 3.6\text{V}$, $C_{IN} = 10\mu\text{F}$, $C_{OUT} = 20\mu\text{F}$, unless otherwise noted.

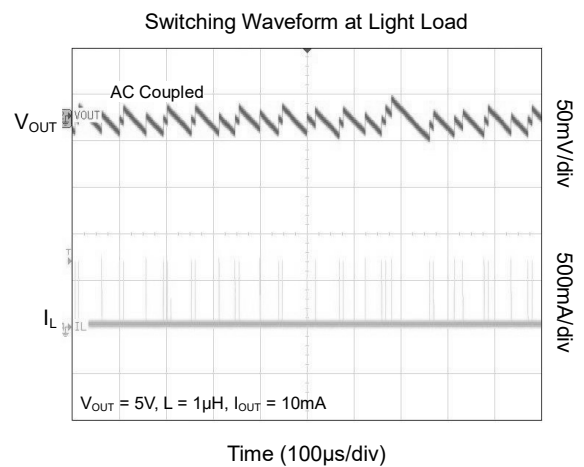
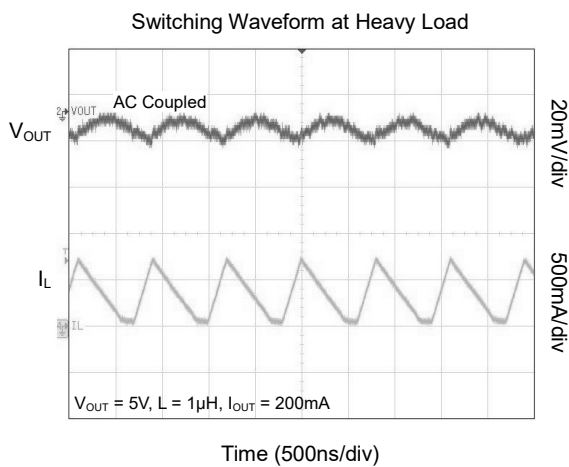
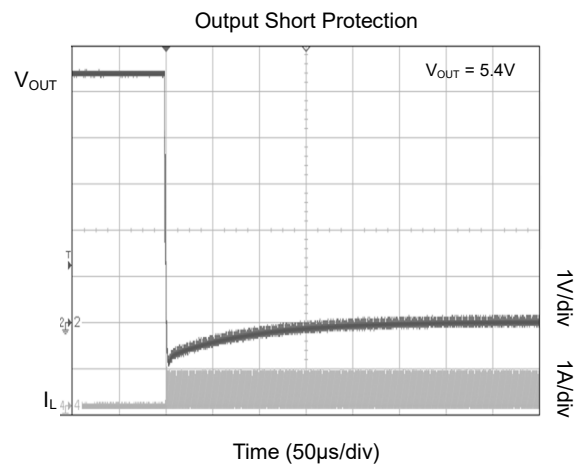
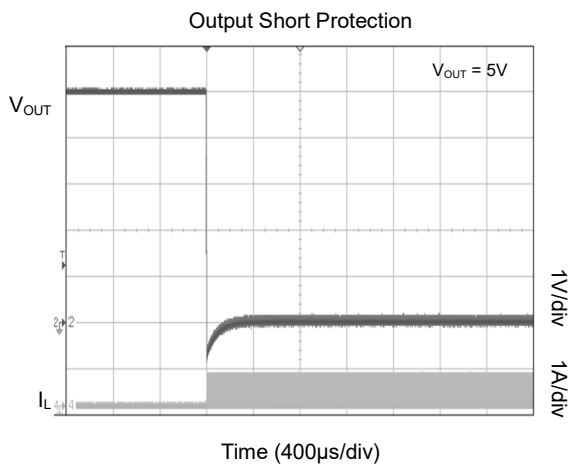
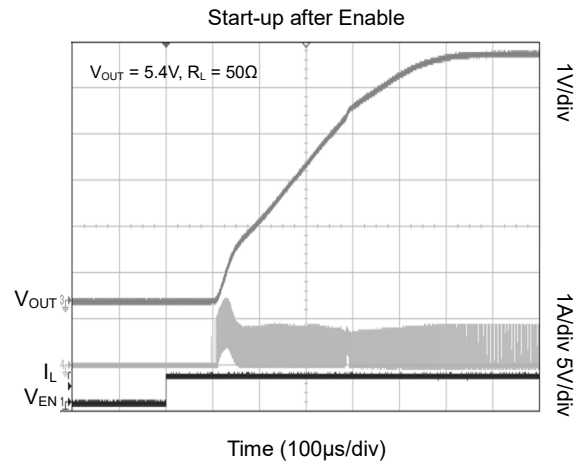
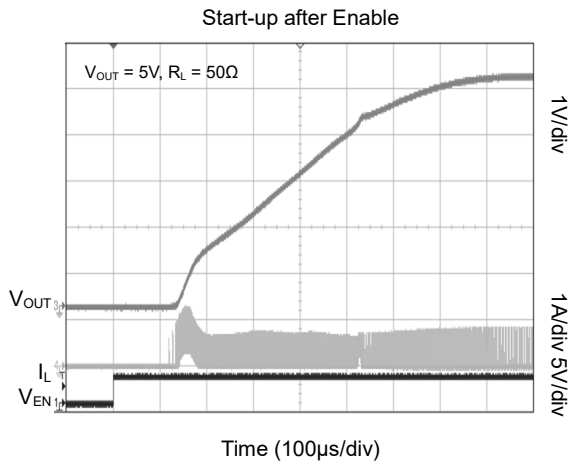

TYPICAL PERFORMANCE CHARACTERISTICS (continued)

At $T_A = +25^\circ\text{C}$, $V_{IN} = 3.6\text{V}$, $C_{IN} = 10\mu\text{F}$, $C_{OUT} = 20\mu\text{F}$, unless otherwise noted.

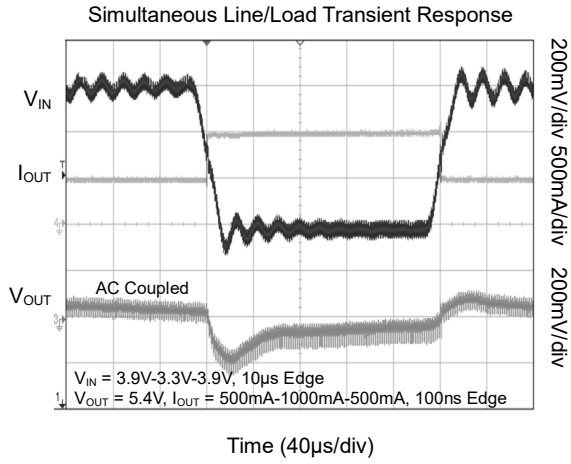

FUNCTIONAL BLOCK DIAGRAM

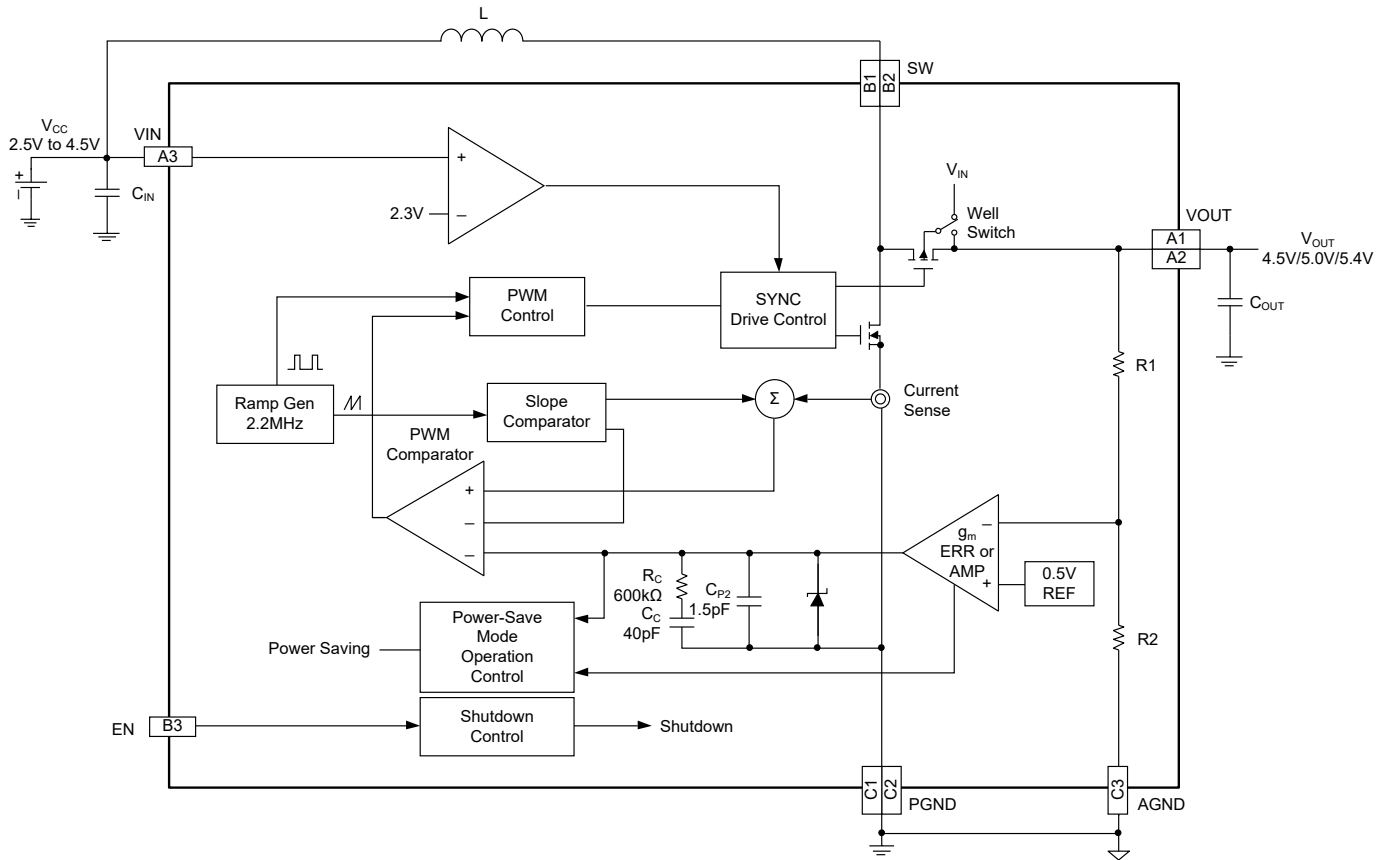

Figure 2. SGM66055 Block Diagram

APPLICATION INFORMATION

The SGM66055 is a Boost DC/DC converter operating in 2.5V to 4.5V supply range for generating a regulated output voltage which can be set to as low as 10% above the supply voltage. An inductor, an output storage capacitor and an input decoupling capacitor should be selected to ensure proper performance desired in a specific application circuit.

Start-up

The SGM66055 has built-in 600 μ s (TYP) soft-start time. After enabling, this device starts switching with reduced switching frequency of 1MHz (TYP). The switching frequency gradually increases to nominal frequency as output voltage increases to the target set-point upon soft-start completing. During the soft-start period, the inductor current is also reduced, and gradually increases to meet the load demand as soft-start completes. This method effectively reduces the inrush current during start-up phase.

Inductor Selection

Inductor is an essential element for current DC/DC switch mode power supplies regardless of topology. Inductor serves as the energy storage element for power conversion. Inductance and saturation current of inductor are two most important criterions for inductor selection. For general design guidance, the selected inductance should provide a peak to peak ripple current that is around 30% of the average inductor current at full load and nominal input voltage. The average inductor current for a Boost converter is the input current. Equation 1 shows the calculation of inductance selection, where f_{SW} is the switching frequency and ΔI_L is the inductor ripple current.

$$L = \frac{V_{IN} \times (V_{OUT} - V_{IN})}{\Delta I_L \times f_{SW} \times V_{OUT}} \quad (1)$$

The selected inductor should have saturation current ratings higher than the 4.2A (TYP) current limit of SGM66055-4.5/5.0 and the 3.0A (TYP) current limit of SGM66055-5.4.

The inductor also affects the close loop response of the DC/DC converter. The SGM66055 is an internally compensated device; the loop response is optimized for inductor in the range of 0.22 μ H and 1 μ H.

Input Capacitor

Boost converter's input capacitor has continuous current throughout the entire switching cycle, a 10 μ F ceramic capacitor is recommended to place as close as possible between the VCC pin and GND pin of the device. For applications where the SGM66055 is located far away from the input source, a 47 μ F or higher capacitance capacitor is recommended to damp the wiring harness inductance.

Output Capacitor

The output capacitors of Boost converter dictate the output voltage ripple and load transient response. Equation 2 is used to estimate the necessary capacitance to achieve desired output voltage ripple, where ΔV is the maximum allowed ripple.

$$C_{MIN} = \frac{I_{OUT} \times (V_{OUT} - V_{IN})}{f_{SW} \times \Delta V \times V_{OUT}} \quad (2)$$

Since SGM66055 is an internally compensated device, the loop response is optimized for capacitor in the range of 10 μ F to 47 μ F. Due to the DC bias nature of ceramic capacitors, care should be taken by verifying manufacture's datasheet to ensure enough effective capacitance at desired output voltage.

Layout Considerations

In addition to component selection, layout is a critical step to ensure the performance of any switch mode power supplies. Poor layout could result in system instability, EMI failure, and device damage. Thus, place the inductor, input and output capacitors as close to the IC as possible, and use wide and short traces for current carrying traces to minimize PCB inductance.

For Boost converter, the current loop of the output capacitor from VOUT pin back to the PGND pin of the device should be as small as possible.

REVISION HISTORY

NOTE: Page numbers for previous revisions may differ from page numbers in the current version.

APRIL 2022 – REV.A.2 to REV.A.3	Page
Updated Application section	10

NOVEMBER 2021 – REV.A.1 to REV.A.2	Page
Updated Start-up section	10

FEBRUARY 2021 – REV.A to REV.A.1	Page
Updated Marking Information section	2

Changes from Original (AUGUST 2018) to REV.A	Page
Changed from product preview to production data	All

PACKAGE OUTLINE DIMENSIONS

TDFN-2x3-8BL

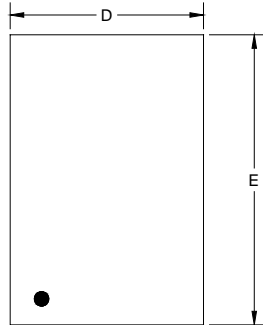

TOP VIEW

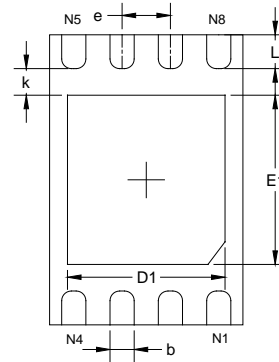

BOTTOM VIEW

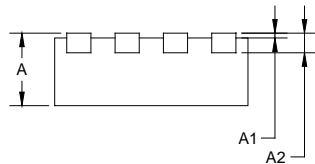

SIDE VIEW

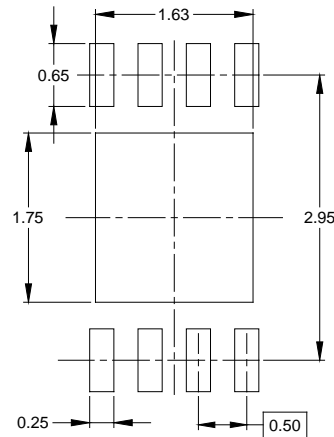

RECOMMENDED LAND PATTERN (Unit: mm)

Symbol	Dimensions In Millimeters		Dimensions In Inches	
	MIN	MAX	MIN	MAX
A	0.700	0.800	0.028	0.031
A1	0.000	0.050	0.000	0.002
A2	0.203 REF		0.008 REF	
D	1.950	2.050	0.077	0.081
D1	1.530	1.730	0.060	0.068
E	2.950	3.050	0.116	0.120
E1	1.650	1.850	0.065	0.073
b	0.200	0.300	0.008	0.012
e	0.500 BSC		0.020 BSC	
k	0.250 REF		0.010 REF	
L	0.300	0.450	0.012	0.018

NOTE: This drawing is subject to change without notice.

PACKAGE OUTLINE DIMENSIONS

WLCSP-1.21x1.21-9B

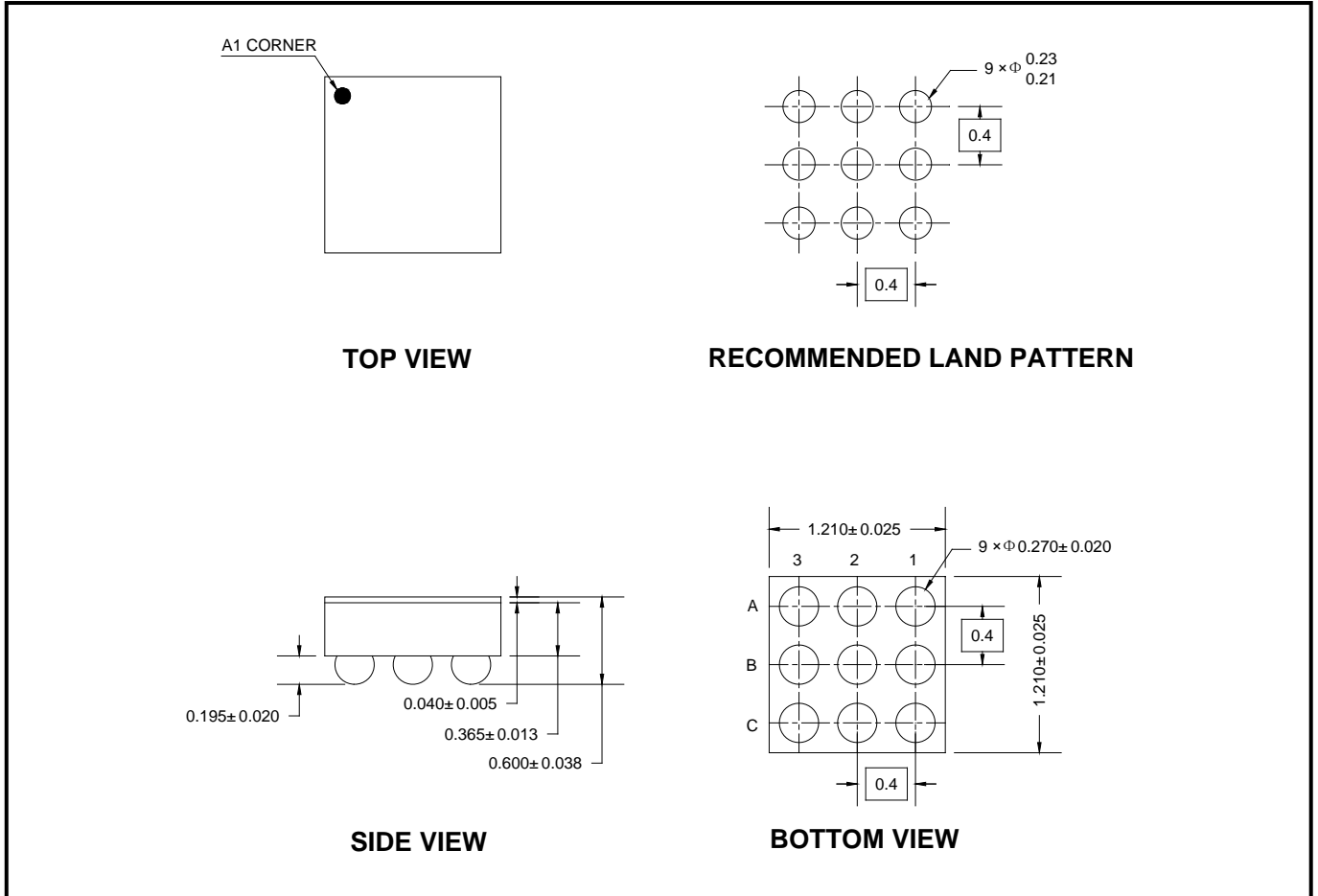

NOTES:

1. All linear dimensions are in millimeters.
2. This drawing is subject to change without notice.

TAPE AND REEL INFORMATION

REEL DIMENSIONS



TAPE DIMENSIONS



NOTE: The picture is only for reference. Please make the object as the standard.

KEY PARAMETER LIST OF TAPE AND REEL

Package Type	Reel Diameter	Reel Width W1 (mm)	A0 (mm)	B0 (mm)	K0 (mm)	P0 (mm)	P1 (mm)	P2 (mm)	W (mm)	Pin1 Quadrant
TDFN-2×3-8BL	7"	9.5	2.30	3.30	1.10	4.0	4.0	2.0	8.0	Q2
WLCSP-1.21×1.21-9B	7"	9.2	1.33	1.33	0.74	4.0	4.0	2.0	8.0	Q1

DD0001

PACKAGE INFORMATION

CARTON BOX DIMENSIONS



NOTE: The picture is only for reference. Please make the object as the standard.

KEY PARAMETER LIST OF CARTON BOX

Reel Type	Length (mm)	Width (mm)	Height (mm)	Pizza/Carton
7" (Option)	368	227	224	8
7"	442	410	224	18

DD0002