

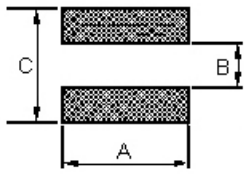

## Recommended Pattern

### SCD 1307



Dimensions in mm

Dim	A	B	C
1307	14	4.5	14

### SCD 03011~SCDR105B

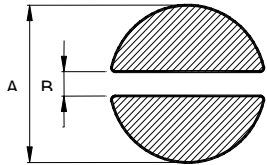

Dimensions in mm

Dim	SCD 03011	SCD 03015	SCD 03021	SCD 0403	SCD 0501	SCD 0502	SCD 0503	SCD 0504	SCD 0506	SCD 0703	SCD 0705	SCD 0706	SCD 1004	SCD 1005	SCD 1006	SCDR 105B
A	4.5	4.5	4.5	5.5	6.8	6.8	6.8	6.8	6.8	8.8	8.8	8.8	11	11	11	12.5
B	1.5	1.0	1.0	1.2	2.0	2.0	2.0	1.3	1.3	2.1	2.1	2.1	2.1	2.1	2.1	2.5

PAD LAYOUT

## Standard Specifications

Stamp	Inductance (μH)	D.C.R (Ω) Max															
		SCD 03011	SCD 03015	SCD 03021	SCD 0403	SCD 0501	SCD 0502	SCD 0503	SCD 0504	SCD 0506	SCD 0703	SCD 0705	SCD 0706	SCD 1004	SCD 1005	SCD 1006	SCDR 105B
1R0	1.0	0.084		0.07	0.033	0.034	0.03	0.03									
1R2	1.2							0.03									
1R4	1.4			0.09	0.038	0.048	0.04								0.02		
1R5	1.5	0.126						0.03									
1R8	1.8			0.11	0.042	0.062	0.05	0.03							0.02		
2R2	2.2	0.18	0.10±30%	0.13	0.047	0.064	0.06	0.03									
2R7	2.7			0.14	0.052	0.078	0.07	0.04							0.02		
3R3	3.3	0.27		0.17	0.058	0.097	0.08	0.05									
3R9	3.9	0.32		0.19	0.076	0.105	0.09	0.06									
4R7	4.7	0.33	0.15±30%	0.21	0.094	0.134	0.14	0.07								0.040	
5R6	5.6	0.48		0.22	0.101	0.170	0.15	0.08									
6R8	6.8	0.56		0.25	0.117	0.187	0.16	0.09									0.037
8R2	8.2	0.62		0.28	0.132	0.225	0.17	0.10									0.05
100	10	0.90	0.30±30%	0.32	0.182	0.255	0.18	0.12	0.10			0.08			0.05	0.060	0.06
120	12	1.00		0.35	0.210	0.292	0.20	0.13	0.12			0.09			0.06	0.070	0.07
150	15	1.10	0.58±30%	0.40	0.235	0.360	0.22	0.15	0.14			0.10	0.09	0.08	0.07	0.080	0.07
180	18	1.24		0.48	0.338	0.430	0.25	0.22	0.15			0.11	0.10		0.08	0.090	0.08
220	22	1.40	0.71±30%	0.58	0.378	0.492	0.35	0.22	0.18	0.165		0.13	0.11		0.09	0.100	0.08
270	27	2.18		0.65	0.522	0.603	0.45	0.26	0.20			0.15	0.12		0.10	0.110	0.10
330	33	2.54	1.10±30%	0.80	0.540	0.796	0.56	0.33	0.23			0.17	0.13	0.14	0.12	0.120	0.11
390	39	2.80		0.90	0.587	0.897	0.69	0.42	0.32			0.22	0.16		0.15	0.140	0.12
470	47	3.10	1.30±30%	1.19	0.844	1.020	0.72	0.50	0.37			0.25	0.18		0.17	0.170	0.14
500	50	3.20		1.22		1.040											
560	56	3.50		1.27	0.937	1.164	0.84	0.55	0.42			0.28	0.24		0.20	0.190	0.19
680	68	5.80	2.20±30%	1.73	1.117	1.220	0.90	0.65	0.46			0.33	0.28		0.22	0.220	0.21
750	75	6.10		1.90		1.340											
820	82	6.60		1.99		1.570	1.20	0.80	0.60			0.41	0.37		0.30	0.25	0.28
101	100		3.50±30%	2.52	2.000	1.800	1.30	0.90	0.70			0.48	0.43		0.34	0.35	0.34
121	120			2.90		2.000	1.38	1.00	0.93			0.54	0.47		0.40	0.40	0.37
151	150			3.36		2.80	1.81	1.30	1.10			0.75	0.64		0.54	0.47	0.51
181	180			5.10		3.15	1.95	1.50	1.38			1.02	0.71		0.62	0.63	0.57
221	220			5.80		4.40	3.00	2.00	1.57			1.20	0.96		0.72	0.73	0.78
271	270			7.80		6.40	3.20	2.50	1.85			1.31	1.11		0.95	0.97	0.87
301	300			8.10		6.75											
331	330			9.24		7.20	3.82	3.20	2.00			1.50	1.26		1.10	1.15	1.20
391	390			10.14		8.40	4.68	3.50	2.60				1.77		1.24	1.30	1.34
461	460			11.15		12.0											
471	470			11.48		12.4	5.10	4.20	3.00				1.96		1.53	1.48	1.50
561	560			19.49		13.0	8.50	4.50	4.19						1.90	1.90	
681	680			22.00		17.0	10.0	6.50	4.44							2.25	
821	820			23.98		19.5	12.0	7.50	5.12							2.55	
102	1000			28.80		24.0	18.0	8.00	10.00								
122	1200		38±30%														
152	1500		55±30%														
602	6000																14
822	8200																50

Test Freq.(L): SCD03011: (100KHz/1V)      SCD03015: (1MHz/1V)  
 SCD03021/0403/0501/0502/ 0503: 1.0 ~ 8.2μH(7.96MHz/1V), 10 ~ 82μH (2.52MHz/1V), 100 ~ 1000μH (1KHz/1V).  
 SCD0504/0506/0703/0705/0706/1004: 1.0 ~ 8.2μH(7.96MHz/1V), 10 ~ 82μH (2.52MHz/1V), 100 ~ 1000μH (1KHz/1V).  
 SCD1005/1006: 1.0 ~ 8.2μH(7.96MHz/1V), 10 ~ 82μH (2.52MHz/1V), 100 ~ 1000μH (1KHz/1V).  
 SCDR105B: 10~88μH(2.52MHz/1V); 100~470uH (KHz/ 0.25V)

Test Instrument: L: Agilent/ E4980 or HP4284A (over 1MHz), HP4285A (under 1MHz)  
 DCR: CH502BC ; Rated D.C. Current: HP4284+42841A or WK3260B+WK3265B

## Standard Specifications

Stamp	Inductance (μH)	Isat (A) Max															
		SCD 03011	SCD 03015	SCD 03021	SCD 0403	SCD 0501	SCD 0502	SCD 0503	SCD 0504	SCD 0506	SCD 0703	SCD 0705	SCD 0706	SCD 1004	SCD 1005	SCD 1006	SCDR 105B
1R0	1.0	1.80		2.080	3.80	4.00	4.50	4.50									
1R2	1.2							4.20									
1R4	1.4			1.860	3.30	3.60	4.00						3.70				
1R5	1.5	1.44						4.10									
1R8	1.8			1.800	2.91	3.00	3.30	3.70					3.70				
2R2	2.2	1.26	0.79	1.390	2.60	2.65	2.94	3.50									
2R7	2.7			1.320	2.43	2.20	2.50	3.20					3.70				
3R3	3.3	1.08		1.250	2.15	2.11	2.35	2.80									
3R9	3.9	1.00		1.200	1.98	2.00	2.20	2.60					3.70				
4R7	4.7	0.90	0.65	1.130	1.70	1.80	2.00	2.50					3.50			2.60	
5R6	5.6	0.76		0.910	1.60	1.60	1.80	2.40					3.30				
6R8	6.8	0.68		0.850	1.41	1.50	1.70	2.20					3.10			4.33	
8R2	8.2	0.63		0.820	1.26	1.30	1.40	2.00					2.70				
100	10	0.56	0.45	0.740	1.15	1.10	1.20	1.80	1.44		1.44		2.30	2.38	2.60		2.06
120	12	0.52		0.640	1.05	1.05	1.18	1.75	1.40			1.39	2.00	2.13	2.45		1.94
150	15	0.50	0.30	0.600	0.92	1.00	1.15	1.70	1.30		1.24	1.80	2.8	1.87	2.27		1.72
180	18	0.46		0.540	0.84	0.95	1.10	1.60	1.23		1.12	1.60		1.73	2.15		1.58
220	22	0.36	0.25	0.500	0.76	0.90	1.00	1.50	1.11	1.6	1.07	1.50		1.60	1.95		1.42
270	27	0.30		0.430	0.71	0.77	0.86	1.40	0.97		0.94	1.30		1.44	1.76		1.32
330	33	0.28	0.20	0.400	0.64	0.68	0.76	1.10	0.88		0.85	1.20	2.3	1.26	1.50		1.16
390	39	0.26		0.370	0.59	0.67	0.75	1.00	0.80		0.74	1.10		1.20	1.37		1.10
470	47	0.25	0.17	0.360	0.54	0.66	0.73	0.90	0.72		0.68	1.10		1.10	1.28		1.00
500	50	0.24		0.330		0.61											
560	56	0.23		0.310	0.50	0.50	0.55	0.85	0.68		0.64	0.94		1.01	1.17		0.93
680	68	0.20	0.13	0.300	0.460	0.47	0.52	0.80	0.61		0.59	0.85		0.91	1.11		0.85
750	75	0.18		0.290		0.46											
820	82	0.17		0.280		0.45	0.50	0.65	0.58		0.54	0.78		0.85	1.00		0.79
101	100		0.10	0.250	0.40	0.36	0.40	0.60	0.52		0.51	0.72		0.74	0.97		0.72
121	120			0.200		0.32	0.36	0.58	0.48		0.49	0.66		0.69	0.89		0.63
151	150			0.190		0.270	0.30	0.43	0.40		0.40	0.58		0.61	0.78		0.55
181	180			0.170		0.230	0.26	0.41	0.38		0.36	0.51		0.56	0.72		0.50
221	220			0.160		0.220	0.25	0.38	0.35		0.31	0.49		0.53	0.66		0.47
271	270			0.140		0.190	0.21	0.35	0.29		0.29	0.42		0.45	0.57		0.41
301	300			0.135		0.180											
331	330			0.130		0.16	0.18	0.28	0.28		0.28	0.40		0.42	0.52		0.37
391	390			0.120		0.150	0.16	0.26	0.26			0.36		0.38	0.48		0.35
461	460			0.090		0.140											
471	470			0.084		0.135	0.15	0.20	0.12			0.34		0.35	0.42		0.33
561	560			0.080		0.130	0.14	0.19	0.10					0.32	0.33		
681	680			0.080		0.120	0.13	0.18	0.08						0.28		
821	820			0.070		0.063	0.07	0.15	0.05						0.24		
102	1000			0.060		0.045	0.05	0.13	0.03								
122	1200		0.05														
152	1500		0.03														
602	6000																0.27
822	8200																0.20

### Tolerance Of Inductors

- SCD03011 1.0 ~ 82μH ± 20%
- SCD03015 2.2 ~ 1500μH ± 20%
- SCD03021 1.0 ~ 1000μH ± 20%
- SCD0403 1.0 ~ 27μH ± 20% 33 ~ 100μH ± 10%
- SCD0501 1.0 ~ 27μH ± 20% 33 ~ 1000μH ± 10%
- SCD0502 1.0 ~ 27μH ± 20% 33 ~ 1000μH ± 10%
- SCD0503 1.0 ~ 27μH ± 20% 33 ~ 1000μH ± 10%
- SCD0504 1.0~27μH±20% 33~47μH ±15% 56~1000μH±10%
- SCD0506 22μH ± 20%
- SCD0703 10 ~ 27μH ± 20% 33 ~ 330μH ± 10%
- SCD0705 1.4 ~ 27μH ± 20% 33 ~ 470μH ± 10%
- SCD0706 15μH ± 20% 33μH ± 10%
- SCD1004 10 ~ 27μH ± 20% 33 ~ 560μH ± 10%
- SCD1005 4.7 ~ 27μH ± 20% 33 ~ 820μH ± 10%
- SCD1005 4.7 ~ 27uH ± 20% 33 ~820uH ± 10%
- SCD1006 6000μH ~8200μH±20%
- SCDR105B 10 ~ 27μH ±20% 33~82μH ±15% 100~4700μH±10%

Tolerance: K = ±10% , M = ±20%

※ This indicates the value of current when the inductance is 10% lower than its initial value at D.C superposition or D.C current when at Δt = 40° whichever is lower

## Electrical Characteristics

Part Number	Inductance ( $\mu$ H)	Tolerance ( $\pm$ %)	Q Ref	Q Frequency (MHz)	SRF (MHz) Typ	DC Resistance (m $\Omega$ ) Typ	I <sub>rms</sub> (A) Max	Isat (A) Typ
SCD1307T-1R5□-N	1.5	20	20	7.96 / 0.1V	65	5.0	9.50	20.0
SCD1307T-2R2□-N	2.2	20	22	7.96 / 0.1V	50	6.0	9.00	18.0
SCD1307T-2R7□-N	2.7	20	24	7.96 / 0.1V	40	8.0	8.20	16.0
SCD1307T-3R3□-N	3.3	20	26	7.96 / 0.1V	38	8.7	7.50	15.0
SCD1307T-4R7□-N	4.7	20	25	7.96 / 0.1V	36	10	7.00	13.0
SCD1307T-5R6□-N	5.6	20	24	7.96 / 0.1V	28	15	6.50	11.0
SCD1307T-6R8□-N	6.8	20	24	7.96 / 0.1V	26	17	6.00	10.5
SCD1307T-8R2□-N	8.2	20	24	7.96 / 0.1V	24	19	5.80	9.8
SCD1307T-100□-N	10	20	22	2.52 / 0.1V	22	21	5.60	9.2
SCD1307T-120□-N	12	20	25	2.52 / 0.1V	20	30	4.80	8.0
SCD1307T-150□-N	15	20	28	2.52 / 0.1V	17	34	4.50	7.5
SCD1307T-180□-N	18	20	28	2.52 / 0.1V	16	36	4.20	7.0
SCD1307T-220□-N	22	20	40	2.52 / 0.1V	15	47	3.60	6.5
SCD1307T-270□-N	27	20	35	2.52 / 0.1V	11	60	3.30	5.5
SCD1307T-330□-N	33	20 / 10	35	2.52 / 0.1V	10	65	3.10	5.0
SCD1307T-390□-N	39	20 / 10	28	2.52 / 0.1V	9.0	75	2.90	4.6
SCD1307T-470□-N	47	20 / 10	24	2.52 / 0.1V	7.5	82	2.70	4.2
SCD1307T-560□-N	56	20 / 10	22	2.52 / 0.1V	7.2	95	2.50	3.8
SCD1307T-680□-N	68	20 / 10	24	2.52 / 0.1V	7.0	120	2.30	3.5
SCD1307T-820□-N	82	20 / 10	18	2.52 / 0.1V	6.0	140	2.10	3.2
SCD1307T-101□-N	100	20 / 10	25	0.796 / 0.1V	5.8	180	1.90	3.0
SCD1307T-121□-N	120	20 / 10	20	0.796 / 0.1V	5.5	210	1.80	2.8
SCD1307T-151□-N	150	20 / 10	20	0.796 / 0.1V	4.5	250	1.60	2.6
SCD1307T-181□-N	180	20 / 10	18	0.796 / 0.1V	4.0	280	1.50	2.3
SCD1307T-221□-N	220	20 / 10	15	0.796 / 0.1V	3.8	360	1.30	2.1
SCD1307T-271□-N	270	20 / 10	15	0.796 / 0.1V	3.5	410	1.20	1.8
SCD1307T-331□-N	330	20 / 10	15	0.796 / 0.1V	3.2	520	1.10	1.6
SCD1307T-391□-N	390	20 / 10	12	0.796 / 0.1V	2.5	600	1.00	1.5
SCD1307T-471□-N	470	20 / 10	12	0.796 / 0.1V	2.2	720	0.90	1.4
SCD1307T-561□-N	560	20 / 10	10	0.796 / 0.1V	2.0	880	0.85	1.3
SCD1307T-681□-N	680	20 / 10	10	0.796 / 0.1V	1.6	1000	0.80	1.2
SCD1307T-821□-N	820	20 / 10	10	0.796 / 0.1V	1.5	1300	0.75	1.1
SCD1307T-102□-N	1000	20 / 10	10	0.252 / 0.1V	1.4	1600	0.65	1.0

- When ordering, please specify tolerance and packaging codes.
- Inductance tested at 0.1 V<sub>rms</sub>, 100KHz.
- Tolerance: K =  $\pm$ 10% , M =  $\pm$ 20%
- Inductance drop = 10%. Typ at Isat
- $\Delta$ T = 40°C rise typ at I<sub>rms</sub>.
- Test Instrument: L / Q : Agilent/ E4980 or HP4284A (over 1MHz), HP4285A (under 1MHz)  
SRF: HP4286A  
RDC: CH502BC  
Isat: HP4284+42841A or WK3260B+WK3265B

# SMD Unshielded Power Inductors - SCD Series

## Test Instruments : HP4294 Impedance / Material Analyzer

### SCD0403

INDUCTANCE vs. FREQUENCY CHARACTERISTICS

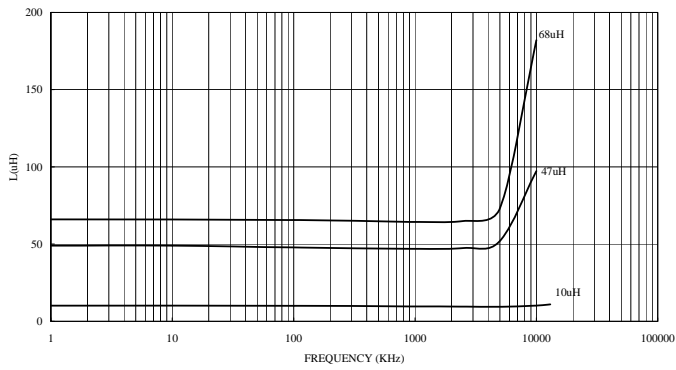

INDUCTANCE vs. IDC CHARACTERISTICS

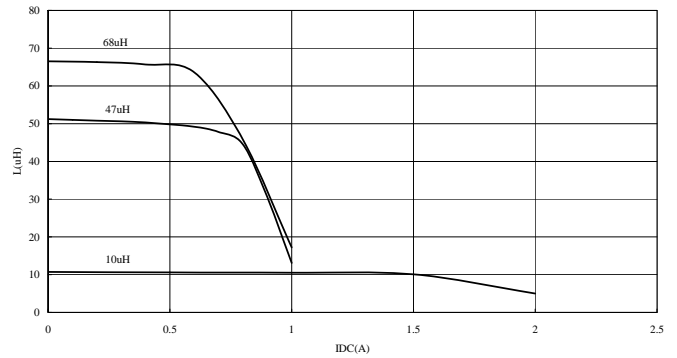

### SCD0504

INDUCTANCE vs. FREQUENCY CHARACTERISTICS

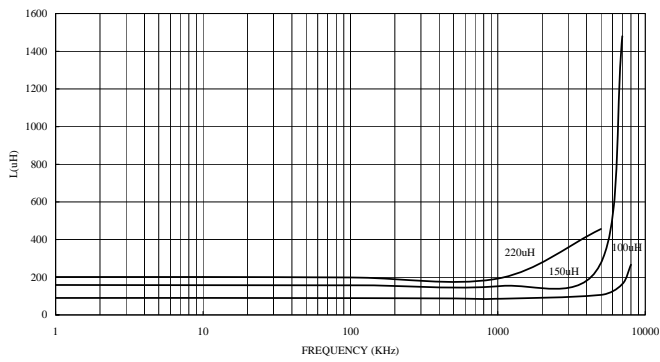

INDUCTANCE vs. IDC CHARACTERISTICS

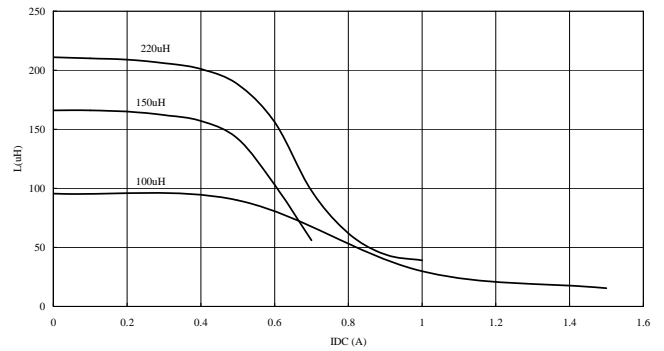

### SCD0703

INDUCTANCE vs. FREQUENCY CHARACTERISTICS

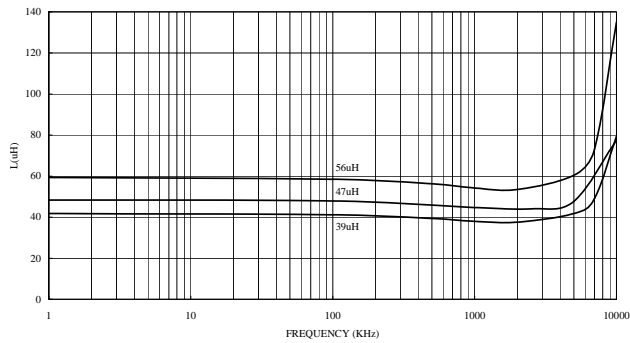

INDUCTANCE vs. IDC CHARACTERISTICS

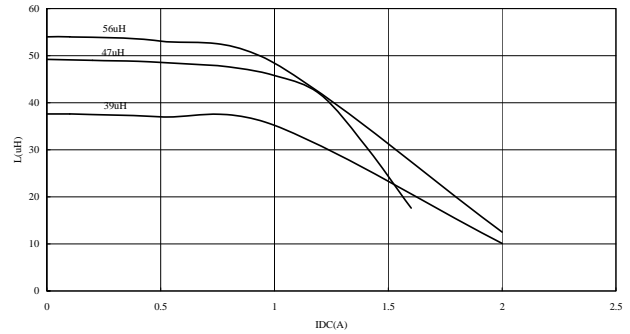

## Test Instruments : HP4294 Impedance / Material Analyzer

### SCD0705

INDUCTANCE vs. FREQUENCY CHARACTERISTICS

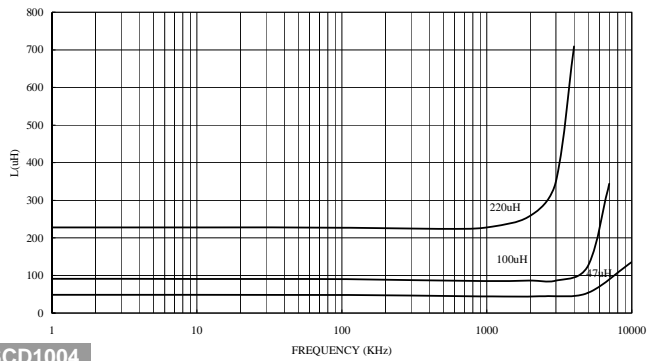

INDUCTANCE vs. IDC CHARACTERISTICS

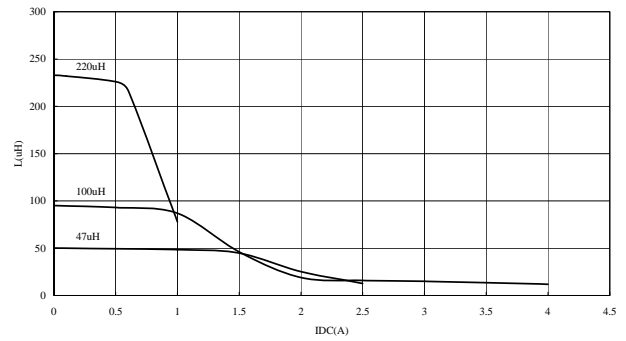

### SCD1004

INDUCTANCE vs. FREQUENCY CHARACTERISTICS

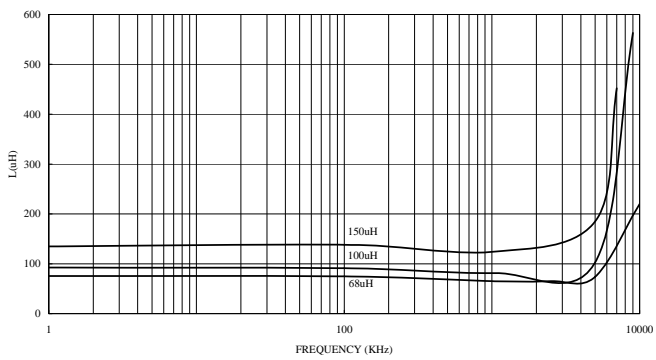

INDUCTANCE vs. IDC CHARACTERISTICS

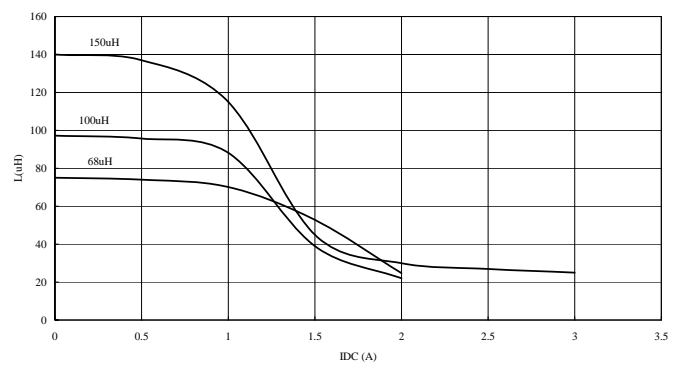

### SCD1005

INDUCTANCE vs. FREQUENCY CHARACTERISTICS

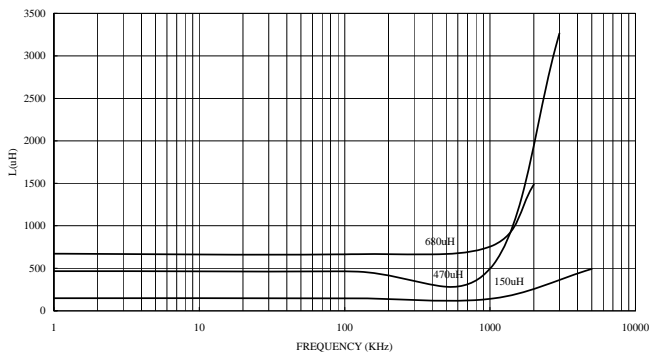

INDUCTANCE vs. IDC CHARACTERISTICS

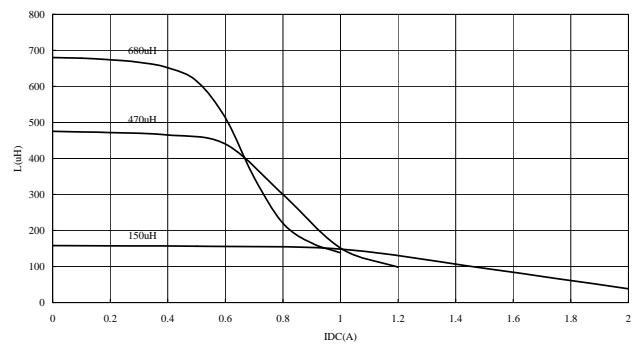

### SCDR105B

INDUCTANCE vs. FREQUENCY CHARACTERISTICS

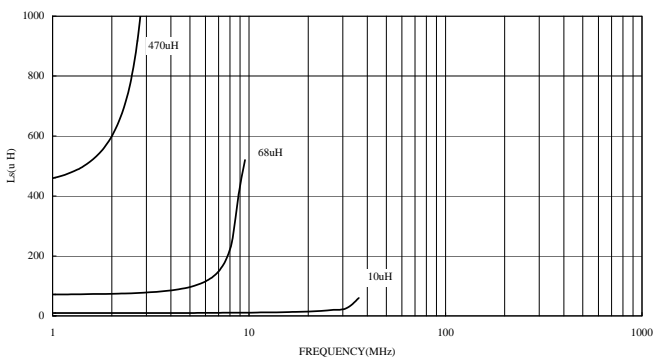

INDUCTANCE vs. IDC CHARACTERISTICS

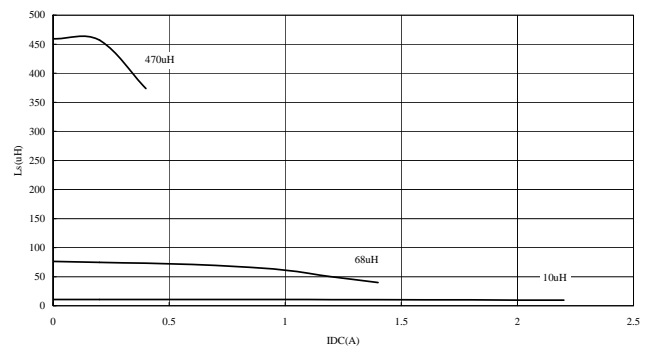

Packaging Specifications

Tape Dimensions



Tape Material

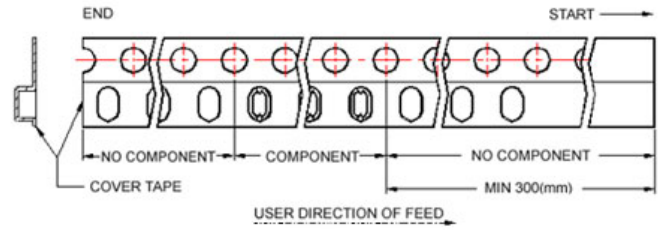

Reel Dimensions

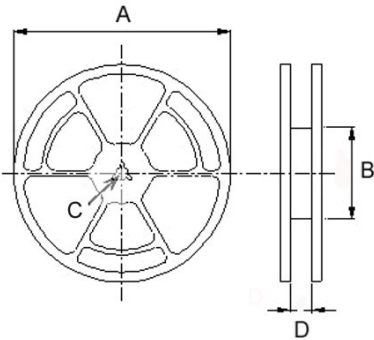

Dimensions in mm

TYPE	Tape Dimensions							Reel Dimensions				Quantity PCS / REEL
	K0	D	E	W	P	P0	P2	A	B	C	D	
SCD03011	1.4	1.50	1.75	12	8	4	2	330	100	13	13.4	3000
SCD03015	1.80	1.55	1.75	12	8	4	2	330	100	13	13.4	3000
SCD03021	2.50	1.55	1.75	12	8	4	2	330	100	13	13.4	3000
SCD0403	3.55	1.55	1.75	12	8	4	2	330	100	13	13.4	2000
SCD0501	2.35	1.55	1.75	12	8	4	2	330	100	13	13.4	2000
SCD0502	3.30	1.50	1.75	16	8	4	2	330	100	13	17.4	2000
SCD0503	3.30	1.50	1.75	16	8	4	2	330	100	13	17.4	2000
SCD0504	4.8	1.55	1.75	16	8	4	2	330	100	13	17.4	1500
SCD0506	6.4	1.55	1.75	16	8	4	2	330	100	13	17.4	1500
SCD0703	3.8	1.55	1.75	16	12	4	2	330	100	13	17.4	1000
SCD0705	5.2	1.55	1.75	16	12	4	2	330	100	13	17.4	700
SCD0706	6.4	1.55	1.75	16	12	4	2	330	100	13	17.4	700
SCD1004	4.5	1.55	1.75	24	12	4	2	330	100	13	24.4	700
SCD1005	5.8	1.55	1.75	24	12	4	2	330	100	13	24.4	700
SCD1006	7.0	1.55	1.75	24	12	4	2	330	100	13	24.4	500
SCDR105B	5.8	1.55	1.75	24	12	4	2	330	100	13	24.4	750
SCD1307	7.4	1.55	1.75	24	16	4	2	330	100	13	24.4	500