

### Product Summary

- $V_{DS} = -30V, I_D = -2A$   
 $R_{DS(ON)} < 190m\Omega @ V_{GS} = -2.5V$   
 $R_{DS(ON)} < 330m\Omega @ V_{GS} = -4.5V$
- Package SOT-23

### Application

- Battery protection
- Load switch
- Power management

### Package and Pin Configuration

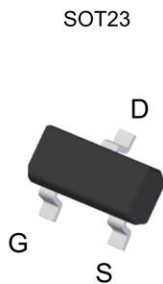

### Circuit diagram

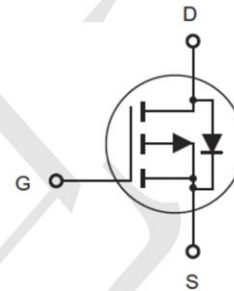

### Marking:



### Absolute Maximum Ratings ( $T_A = 25^\circ C$ unless otherwise noted)

Parameter	Symbol	Limit	Unit
Drain-Source Voltage	$V_{DS}$	-30	V
Gate-Source Voltage	$V_{GS}$	$\pm 20$	V
Drain Current-Continuous	$I_D$	-2	A
Drain Current -Pulsed <sup>(Note 1)</sup>	$I_{DM}$	-10	A
Maximum Power Dissipation	$P_D$	1	W
Operating Junction and Storage Temperature Range	$T_J, T_{STG}$	-55 To 150	$^\circ C$

### Thermal Characteristic

Thermal Resistance, Junction-to-Ambient <sup>(Note 2)</sup>	$R_{\theta JA}$	125	$^\circ C/W$
---	-----------------	-----	--------------

**Electrical Characteristics ( $T_A=25^\circ\text{C}$  unless otherwise noted)**

Parameter	Symbol	Test Condition	Min	Typ	Max	Units	
<b>Static</b>							
Drain-Source Breakdown Voltage	$V_{(BR)DSS}$	$V_{GS} = 0V, I_D = -250\mu A$	-30			V	
Gate-Source Threshold Voltage	$V_{GS(th)}$	$V_{DS} = V_{GS}, I_D = -250\mu A$	-1	-1.6	-3		
Gate-Source Leakage	$I_{GSS}$	$V_{DS} = 0V, V_{GS} = \pm 20V$			$\pm 100$	nA	
Zero Gate Voltage Drain Current	$I_{DSS}$	$V_{DS} = -30V, V_{GS} = 0V$			-1	$\mu A$	
Drain-Source On-State Resistance <sup>a</sup>	$R_{DS(on)}$	$V_{GS} = -10V, I_D = -1.9A$			0.190	$\Omega$	
		$V_{GS} = -4.5V, I_D = -1.4A$			0.330		
Forward Transconductance <sup>a</sup>	$g_{fs}$	$V_{DS} = -5V, I_D = -1.9A$	1			S	
<b>Dynamic<sup>b</sup></b>							
Input Capacitance	$C_{iss}$	$V_{DS} = -15V, V_{GS} = 0V, f = 1MHz$		155		pF	
Output Capacitance	$C_{oss}$			35			
Reverse Transfer Capacitance	$C_{rss}$			25			
Total Gate Charge	$Q_g$	$V_{DS} = -15V, V_{GS} = -10V, I_D = -1.9A$		4	8	nC	
		$V_{DS} = -15V, V_{GS} = -4.5V, I_D = -1.9A$		2	4		
Gate-Source Charge	$Q_{gs}$	$V_{DS} = -15V, V_{GS} = -4.5V, I_D = -1.9A$		0.6			
Gate-Drain Charge	$Q_{gd}$			1			
Gate Resistance	$R_g$	$f = 1MHz$	1.7	8.5	17	$\Omega$	
Turn-On Delay Time	$t_{d(on)}$	$V_{DD} = -15V,$ $R_L = 10\Omega, I_D = -1.5A,$ $V_{GEN} = -10V, R_g = 1\Omega$		4	8	ns	
Rise Time	$t_r$			11	18		
Turn-Off Delay Time	$t_{d(off)}$			11	18		
Fall Time	$t_f$			8	16		
Turn-On Delay Time	$t_{d(on)}$		$V_{DD} = -15V,$ $R_L = 10\Omega, I_D = -1.5A,$ $V_{GEN} = -4.5V, R_g = 1\Omega$		36		44
Rise Time	$t_r$				37		45
Turn-Off Delay Time	$t_{d(off)}$				12		18
Fall Time	$t_f$				9		14
<b>Drain-source Body diode characteristics</b>							
Continuous Source-Drain Diode Current	$I_S$	$T_C = 25^\circ C$			-2	A	
Pulse Diode Forward Current <sup>a</sup>	$I_{SM}$				-10		
Body Diode Voltage	$V_{SD}$	$I_S = -1.5A$		-0.8	-1.2	V	

Typical Electrical and Thermal Characteristics

Output Characteristics

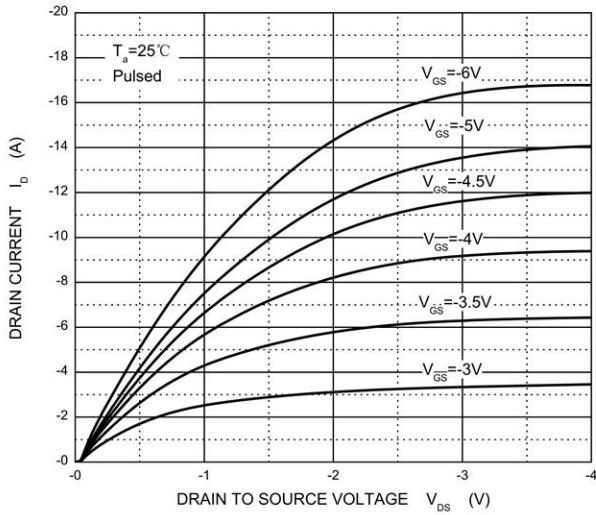

Transfer Characteristics

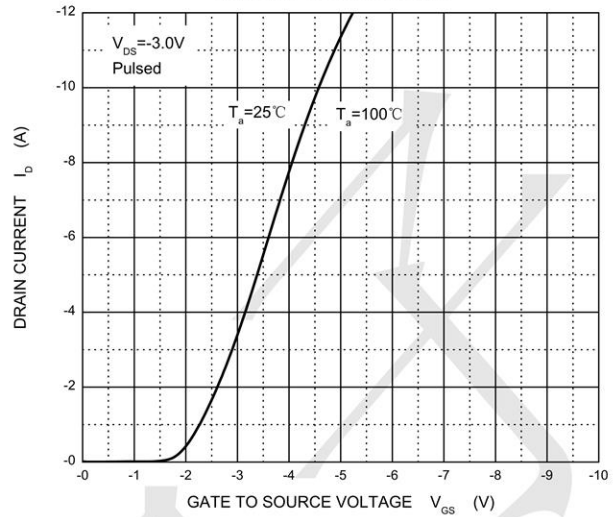

$R_{DS(ON)}$  —  $I_D$

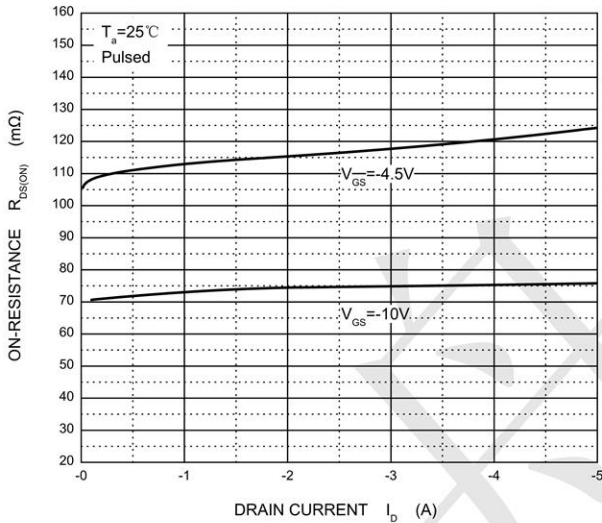

$R_{DS(ON)}$  —  $V_{GS}$

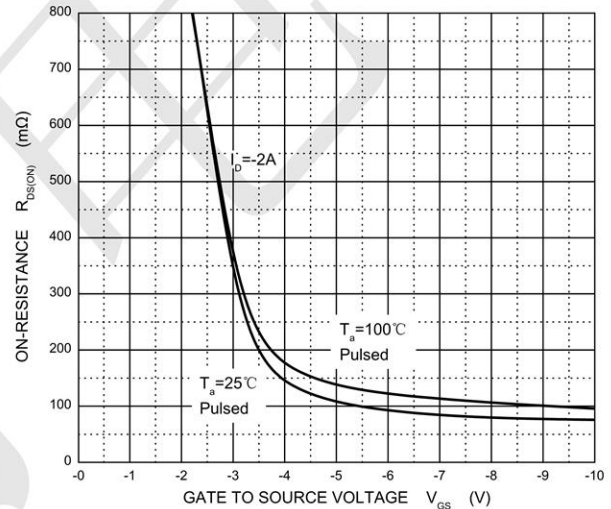

$I_S$  —  $V_{SD}$

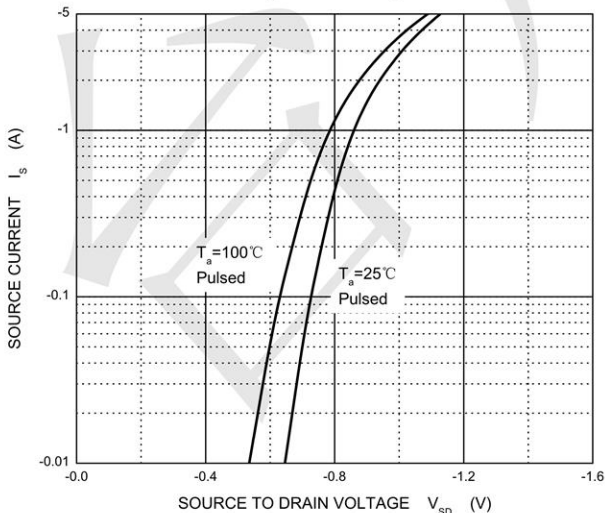

Threshold Voltage

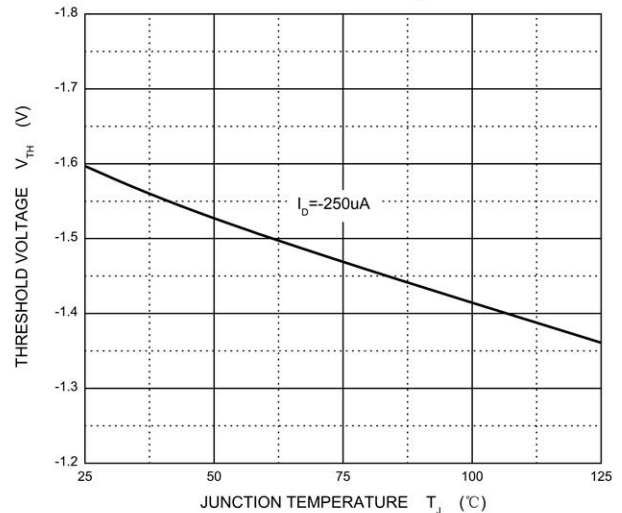

**SOT-23 Package Information**

(UNIT): mm

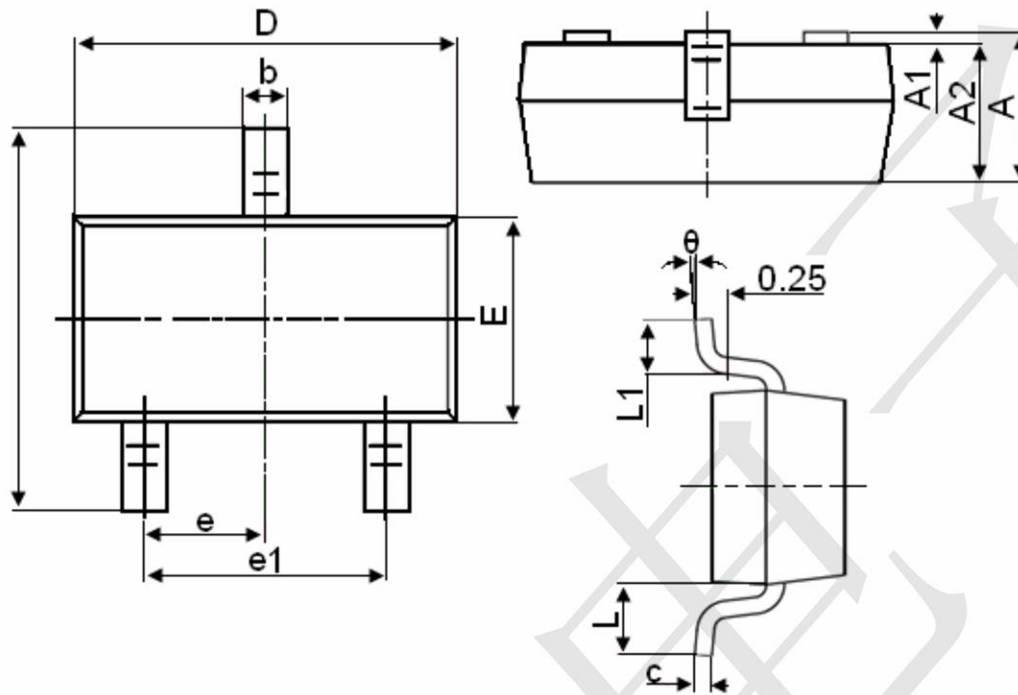

Symbol	Dimensions in Millimeters	
	MIN.	MAX.
A	0.900	1.150
A1	0.000	0.100
A2	0.900	1.050
b	0.300	0.500
c	0.080	0.150
D	2.800	3.000
E	1.200	1.400
E1	2.250	2.550
e	0.950TYP	
e1	1.800	2.000
L	0.550REF	
L1	0.300	0.500
θ	0°	8°