

GENERAL FEATURES

- $V_{DS} = -60V$ $I_D = -3.8A$
- $R_{DS(ON)} < -98m\Omega$ @ $V_{GS}=10V$
- $R_{DS(ON)} < -145m\Omega$ @ $V_{GS}=4.5V$

Application

- Load/Power Switching
- Interfacing Switching
- Logic Level Shift

Package and Pin Configuration

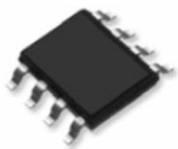

SOP-8 top view

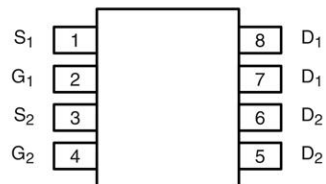

Marking:

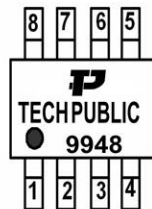

Circuit diagram

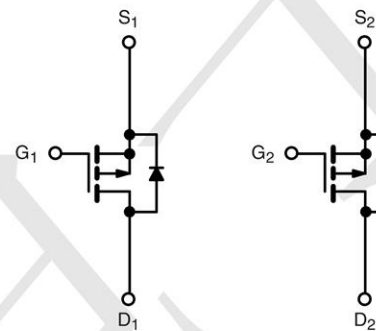

Absolute Maximum Ratings ($T_A=25^\circ C$ unless otherwise noted)

Parameter	Symbol	Value	Unit
Drain-Source Voltage	V_{DSS}	-60	V
Continuous Drain Current	I_D	-3.8	A
Pulsed Drain Current (note1)	I_{DM}	-16	A
Gate-Source Voltage	V_{GSS}	± 20	V
Single Pulse Avalanche Energy (note2)	E_{AS}	36	mJ
Avalanche Current	I_{AS}	12	A
Power Dissipation ($T_C = 25^\circ C$) (note3)	P_D	2.3	W
Operating Junction and Storage Temperature Range	T_J, T_{stg}	-55 To 150	$^\circ C$

Thermal Data

Symbol	Parameter	Value	Unit
Rthj-a	Thermal Resistance Junction-ambient ³	Max. 40	$^\circ C/W$

Electrical Characteristics (T_J=25°C unless otherwise noted)

Specifications T _J = 25°C, unless otherwise noted						
Parameter	Symbol	Test Conditions	Value			Unit
			Min.	Typ.	Max.	
Static						
Drain-Source Breakdown Voltage	V _{(BR)DSS}	V _{GS} = 0V, I _D = -250μA	-60	--	--	V
Zero Gate Voltage Drain Current	I _{DSS}	V _{DS} = -60V, V _{GS} = 0V, T _J = 25°C	--	--	-1	μA
		V _{DS} = -60V, V _{GS} = 0V, T _J = 150°C	--	--	-100	
Gate-Source Leakage	I _{GSS}	V _{GS} = ±20V	--	--	±100	nA
Gate-Source Threshold Voltage	V _{GS(th)}	V _{DS} = V _{GS} , I _D = -250μA	-1.0	-1.7	-3.0	V
Drain-Source On-Resistance (Note3)	R _{DS(on)}	V _{GS} = -10V, I _D = -4A	--	90	98	mΩ
		V _{GS} = -4.5V, I _D = -3A	--	100	145	mΩ
Dynamic						
Input Capacitance	C _{iss}	V _{GS} = 0V, V _{DS} = -30V, f = 1.0MHz	--	976	--	pF
Output Capacitance	C _{oss}		--	70	--	
Reverse Transfer Capacitance	C _{rss}		--	30	--	
Total Gate Charge	Q _g	V _{DD} = -30V, I _D = -4A, V _{GS} = -10V	--	24	--	nC
Gate-Source Charge	Q _{gs}		--	2.2	--	
Gate-Drain Charge	Q _{gd}		--	3.6	--	
Turn-on Delay Time	t _{d(on)}	V _{DD} = -30V, I _D = -4A, R _G = 2.5Ω	--	10	--	ns
Turn-on Rise Time	t _r		--	5	--	
Turn-off Delay Time	t _{d(off)}		--	35	--	
Turn-off Fall Time	t _f		--	9	--	
Drain-Source Body Diode Characteristics						
Continuous Body Diode Current	I _S	T _C = 25°C	--	--	-3.8	A
Pulsed Diode Forward Current	I _{SM}		--	--	-16	
Body Diode Voltage	V _{SD}	T _J = 25°C, I _{SD} = -4A, V _{GS} = 0V	--	--	-1.2	V
Reverse Recovery Time	t _{rr}	I _F = -4A, di _F /dt = 100A/μs	--	36	--	ns
Reverse Recovery Charge	Q _{rr}		--	38	--	nC

Typical Electrical and Thermal Characteristics

Figure 1. Output Characteristics

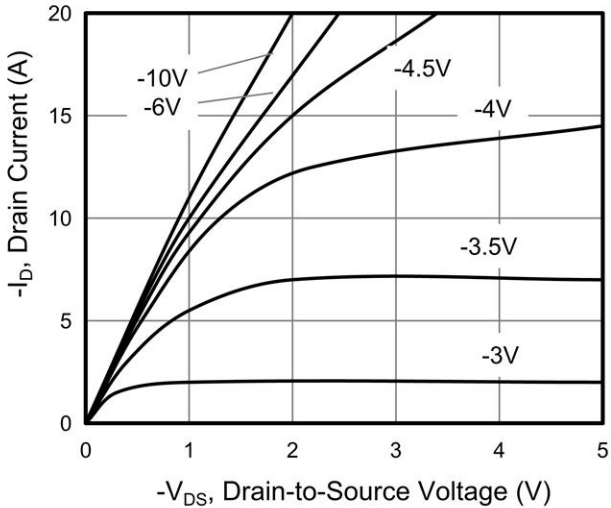

Figure 2. Transfer Characteristics

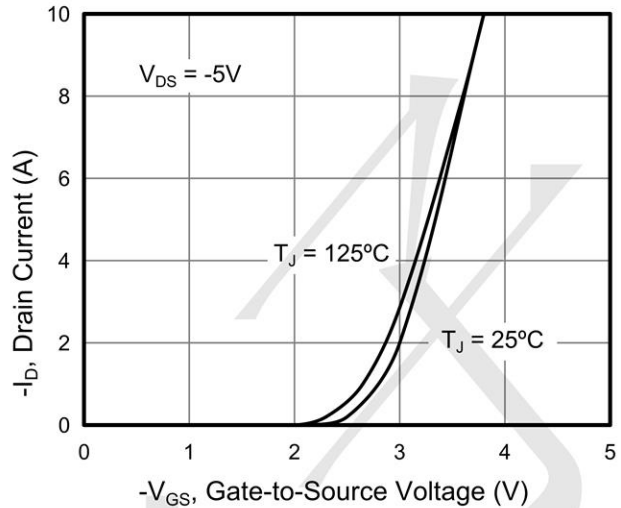

Figure 3. On-Resistance vs. Drain Current

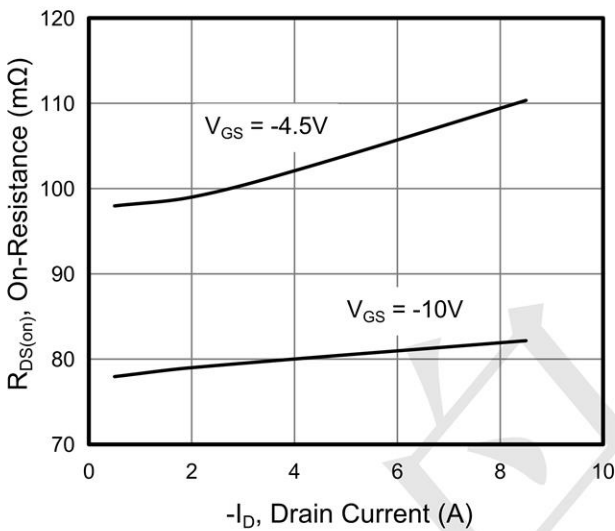

Figure 4. On-Resistance vs. Junction Temperature

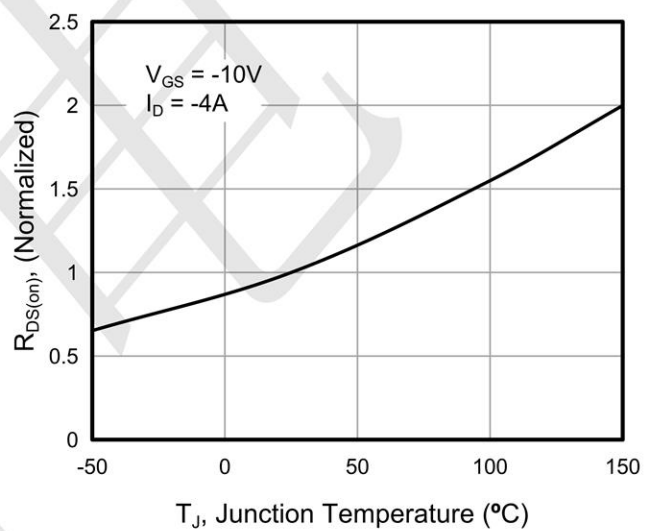

Figure 5. Threshold Voltage vs. Junction Temperature

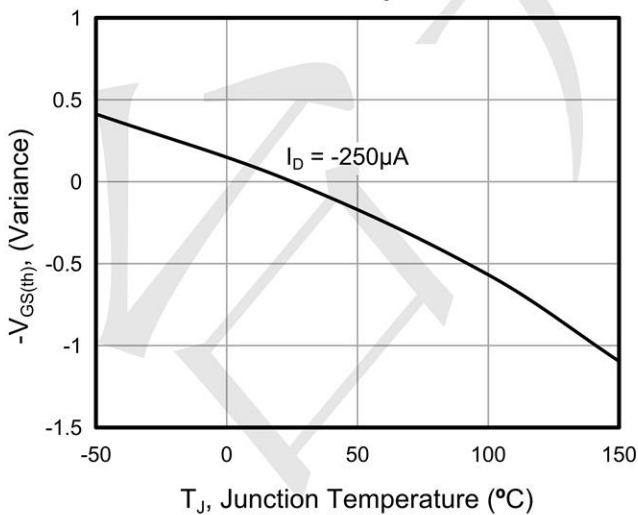

Figure 6. Body Diode Forward Voltage

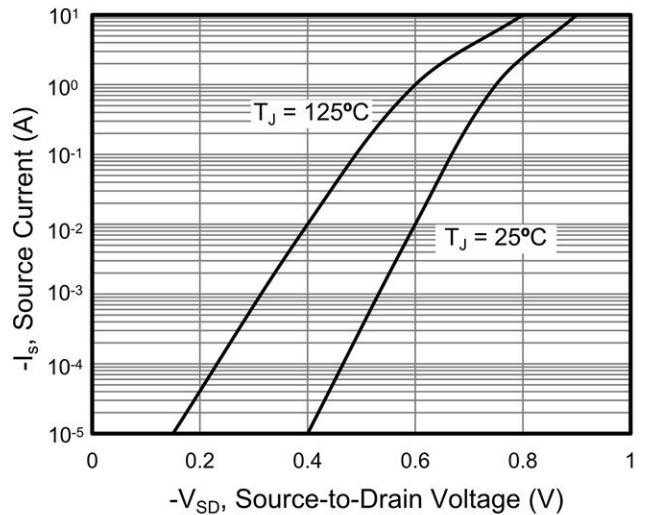

Figure 7. Capacitance

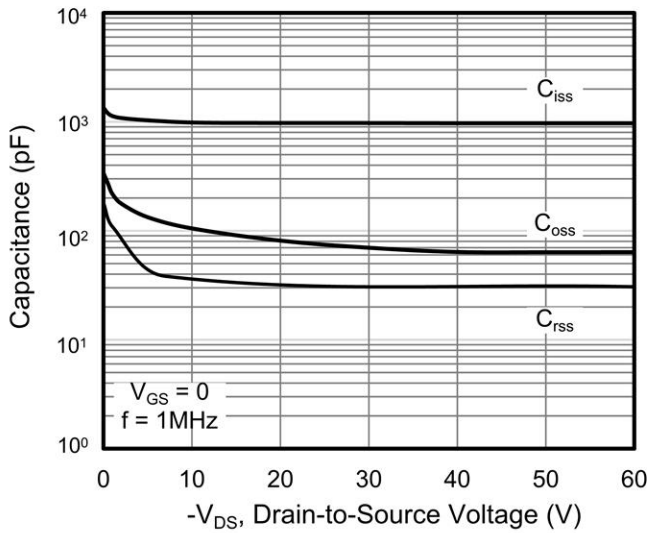

Figure 8. Gate Charge

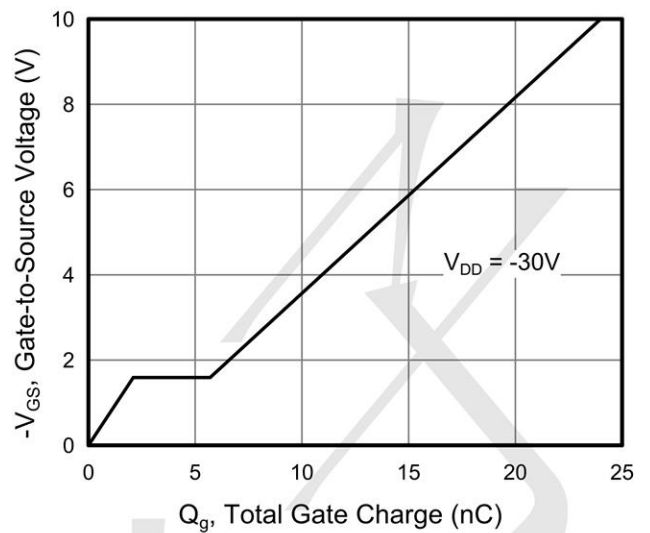

Figure 9. Transient Thermal Impedance

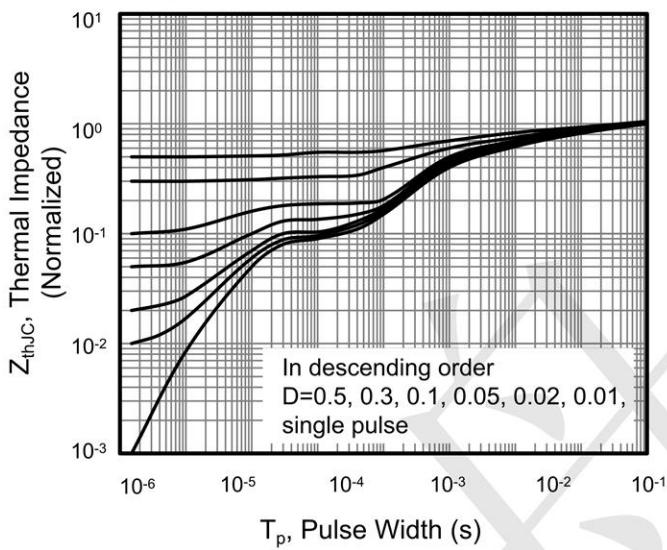
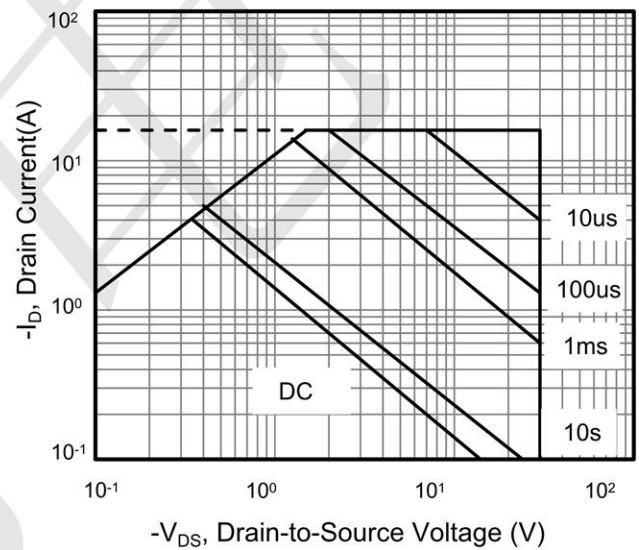
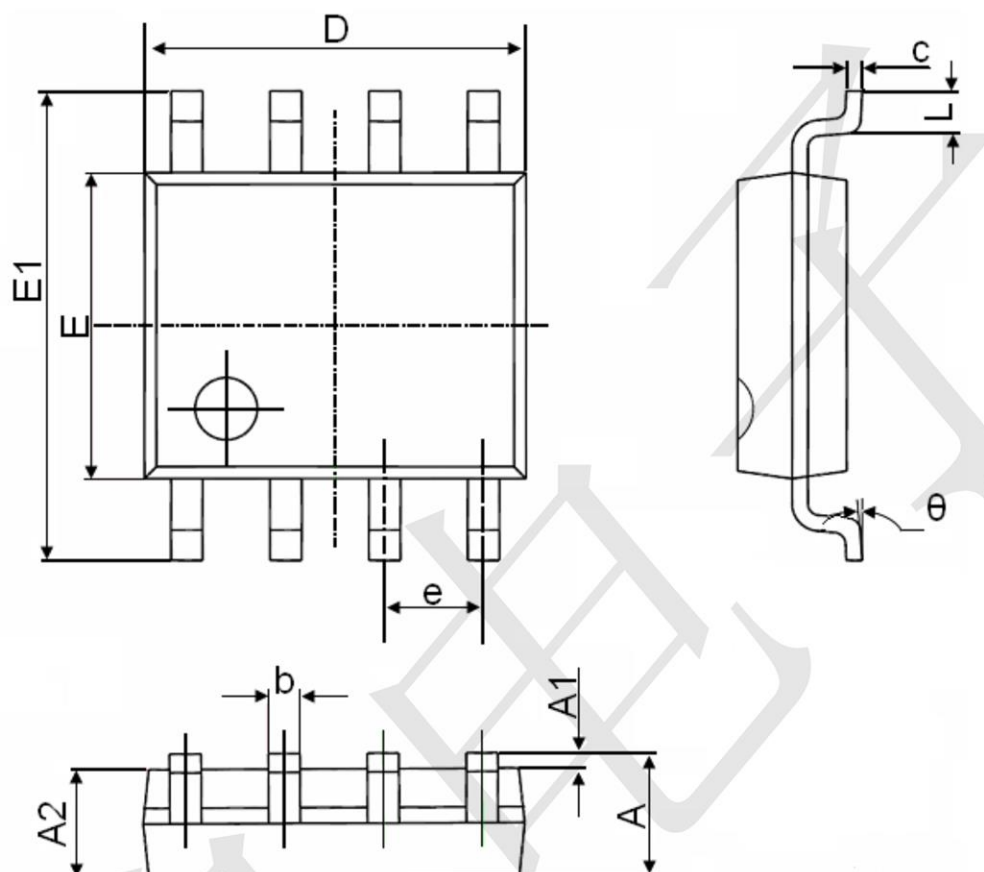

Figure 10. Safe Operating Area



SOP-8 Package Information



Symbol	Dimensions In Millimeters		Dimensions In Inches	
	Min.	Max.	Min.	Max.
A	1.350	1.750	0.053	0.069
A1	0.100	0.250	0.004	0.010
A2	1.350	1.550	0.053	0.061
b	0.330	0.510	0.013	0.020
c	0.170	0.250	0.006	0.010
D	4.700	5.100	0.185	0.200
E	3.800	4.000	0.150	0.157
E1	5.800	6.200	0.228	0.244
e	1.270(BSC)		0.050(BSC)	
L	0.400	1.270	0.016	0.050
θ	0°	8°	0°	8°