

Product Summary

- $V_{DS} = -30V, I_D = -2A$
 $R_{DS(ON)} < 190m\Omega @ V_{GS} = -2.5V$
 $R_{DS(ON)} < 330m\Omega @ V_{GS} = -4.5V$
- Package SOT-23

Application

- Battery protection
- Load switch
- Power management

Package and Pin Configuration

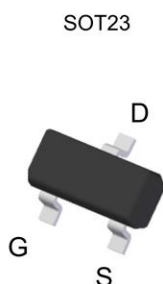

Circuit diagram

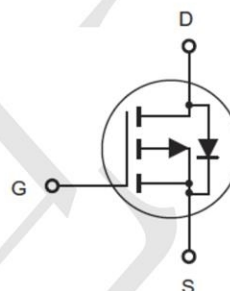

Marking:



Absolute Maximum Ratings ($T_A = 25^\circ C$ unless otherwise noted)

Parameter	Symbol	Limit	Unit
Drain-Source Voltage	V_{DS}	-30	V
Gate-Source Voltage	V_{GS}	± 20	V
Drain Current-Continuous	I_D	-2	A
Drain Current -Pulsed ^(Note 1)	I_{DM}	-10	A
Maximum Power Dissipation	P_D	1	W
Operating Junction and Storage Temperature Range	T_J, T_{STG}	-55 To 150	$^\circ C$

Thermal Characteristic

Thermal Resistance, Junction-to-Ambient ^(Note 2)	$R_{\theta JA}$	125	$^\circ C/W$
-------------------------------------------------------------	-----------------	-----	--------------

Electrical Characteristics ($T_A=25^\circ\text{C}$ unless otherwise noted)

Parameter	Symbol	Test Condition	Min	Typ	Max	Units	
Static							
Drain-Source Breakdown Voltage	$V_{(BR)DSS}$	$V_{GS} = 0V, I_D = -250\mu A$	-30			V	
Gate-Source Threshold Voltage	$V_{GS(th)}$	$V_{DS} = V_{GS}, I_D = -250\mu A$	-1	-1.6	-3		
Gate-Source Leakage	I_{GSS}	$V_{DS} = 0V, V_{GS} = \pm 20V$			± 100	nA	
Zero Gate Voltage Drain Current	I_{DSS}	$V_{DS} = -30V, V_{GS} = 0V$			-1	μA	
Drain-Source On-State Resistance ^a	$R_{DS(on)}$	$V_{GS} = -10V, I_D = -1.9A$			0.190	Ω	
		$V_{GS} = -4.5V, I_D = -1.4A$			0.330		
Forward Transconductance ^a	g_{fs}	$V_{DS} = -5V, I_D = -1.9A$	1			S	
Dynamic^b							
Input Capacitance	C_{iss}	$V_{DS} = -15V, V_{GS} = 0V, f = 1MHz$		155		pF	
Output Capacitance	C_{oss}			35			
Reverse Transfer Capacitance	C_{rss}			25			
Total Gate Charge	Q_g	$V_{DS} = -15V, V_{GS} = -10V, I_D = -1.9A$		4	8	nC	
		$V_{DS} = -15V, V_{GS} = -4.5V, I_D = -1.9A$		2	4		
Gate-Source Charge	Q_{gs}	$V_{DS} = -15V, V_{GS} = -4.5V, I_D = -1.9A$		0.6			
Gate-Drain Charge	Q_{gd}			1			
Gate Resistance	R_g	$f = 1MHz$	1.7	8.5	17	Ω	
Turn-On Delay Time	$t_{d(on)}$	$V_{DD} = -15V,$ $R_L = 10\Omega, I_D = -1.5A,$ $V_{GEN} = -10V, R_g = 1\Omega$		4	8	ns	
Rise Time	t_r			11	18		
Turn-Off Delay Time	$t_{d(off)}$			11	18		
Fall Time	t_f			8	16		
Turn-On Delay Time	$t_{d(on)}$		$V_{DD} = -15V,$ $R_L = 10\Omega, I_D = -1.5A,$ $V_{GEN} = -4.5V, R_g = 1\Omega$		36		44
Rise Time	t_r				37		45
Turn-Off Delay Time	$t_{d(off)}$				12		18
Fall Time	t_f				9		14
Drain-source Body diode characteristics							
Continuous Source-Drain Diode Current	I_S	$T_C = 25^\circ C$			-2	A	
Pulse Diode Forward Current ^a	I_{SM}				-10		
Body Diode Voltage	V_{SD}	$I_S = -1.5A$		-0.8	-1.2	V	

Typical Electrical and Thermal Characteristics

Output Characteristics

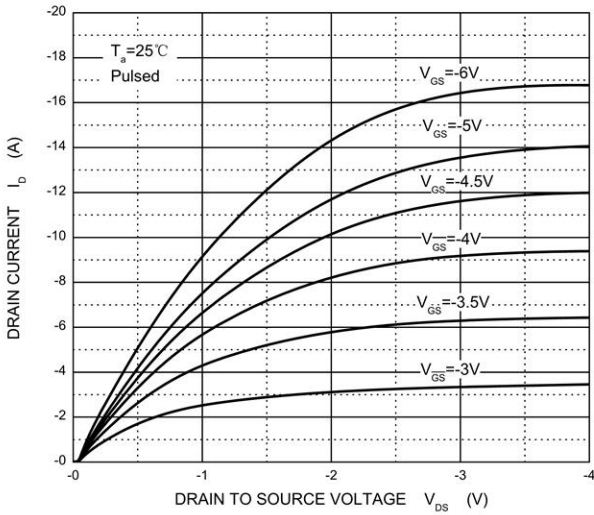

Transfer Characteristics

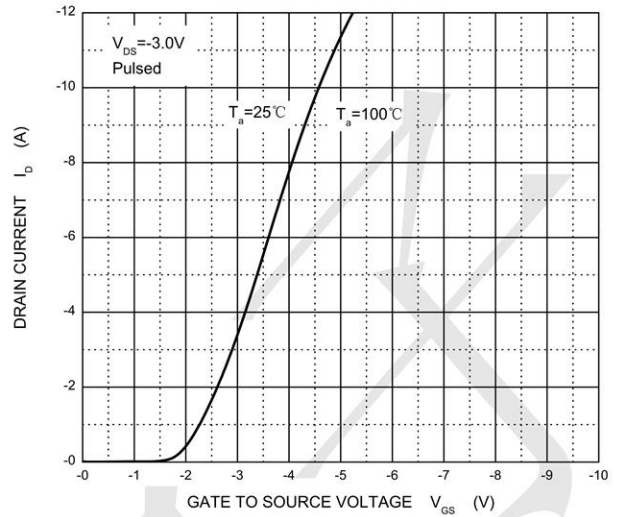

$R_{DS(ON)}$ — I_D

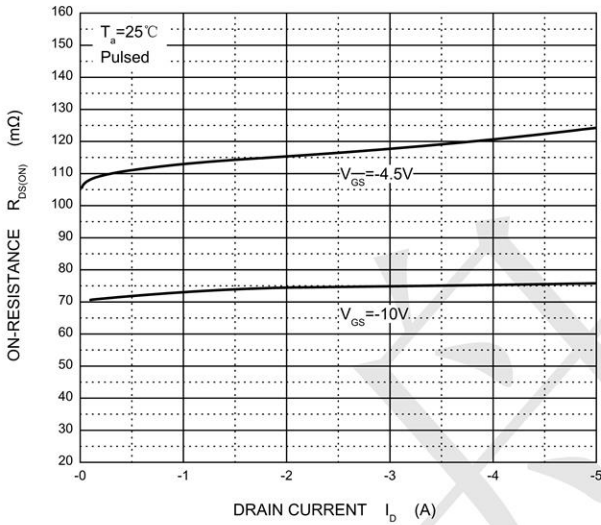

$R_{DS(ON)}$ — V_{GS}

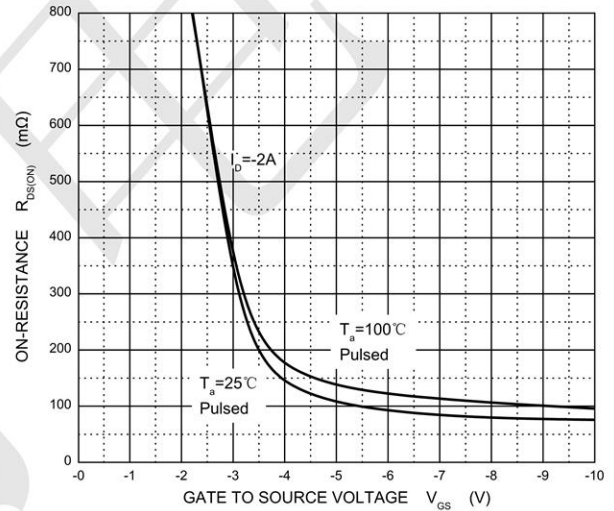

I_S — V_{SD}

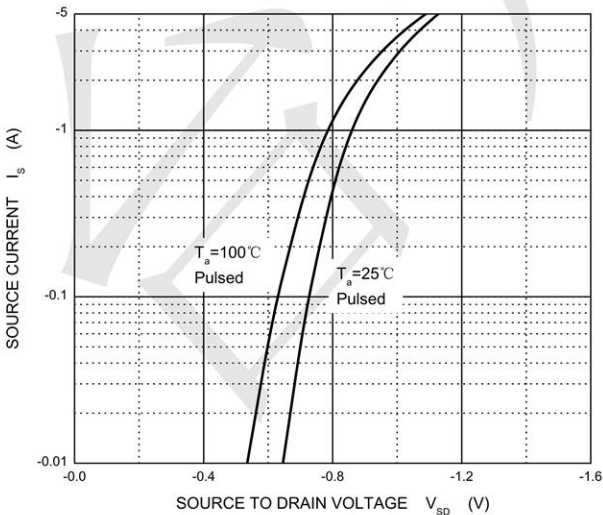

Threshold Voltage

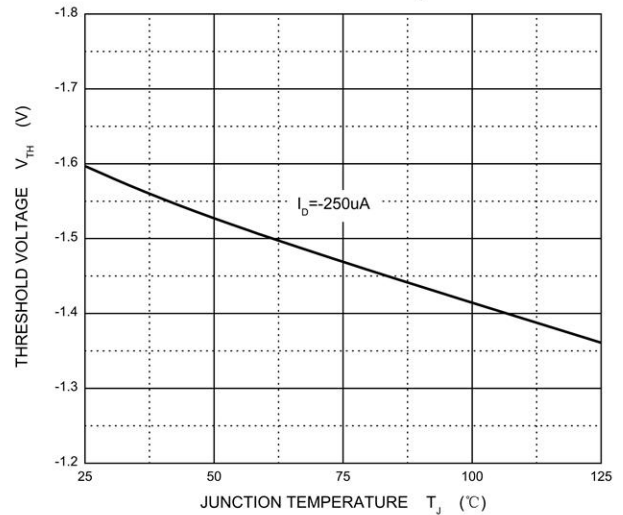

SOT-23 Package Information

(UNIT): mm

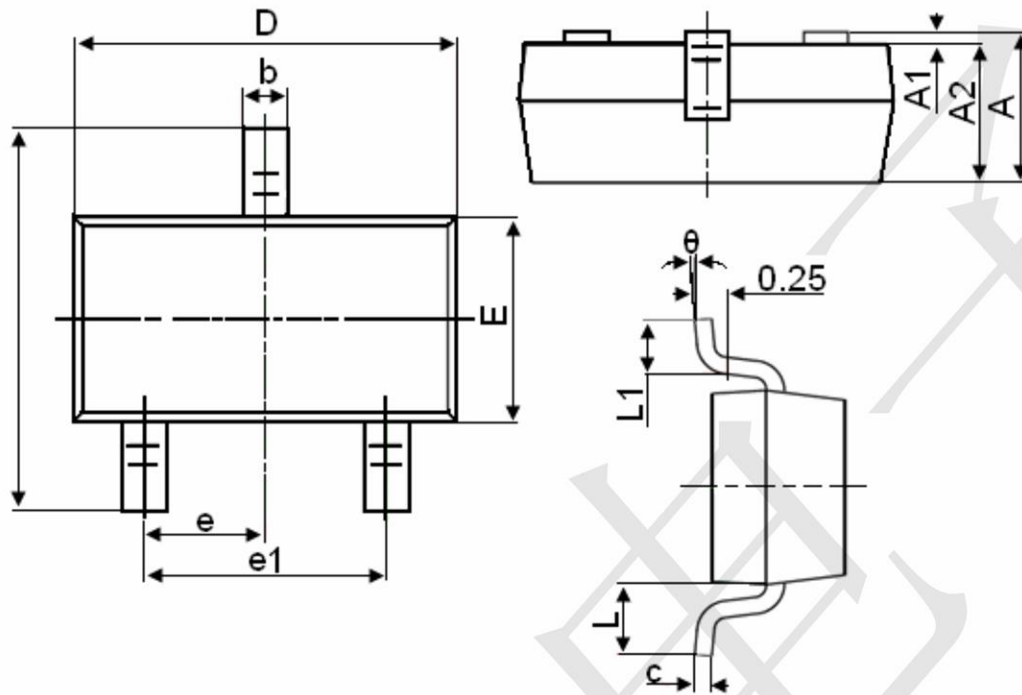

Symbol	Dimensions in Millimeters	
	MIN.	MAX.
A	0.900	1.150
A1	0.000	0.100
A2	0.900	1.050
b	0.300	0.500
c	0.080	0.150
D	2.800	3.000
E	1.200	1.400
E1	2.250	2.550
e	0.950TYP	
e1	1.800	2.000
L	0.550REF	
L1	0.300	0.500
θ	0°	8°