



SGM8555/SGM8556

Single-Supply, Single Rail-to-Rail I/O Precision Operational Amplifiers

GENERAL DESCRIPTION

The single SGM8555 and dual SGM8556 are precision operational amplifiers which can operate from 2.5V to 5.5V single supply. These devices provide rail-to-rail input and output operation.

The SGM8555/6 offer a low offset voltage less than 90 μ V and an ultra-low bias current of 30pA. The combination of characteristics makes the SGM8555/6 good choices for temperature measurements, pressure and position sensors, strain gauge amplifiers and medical instrumentation, or any other 2.5V to 5.5V applications requiring precision and long-term stability.

The SGM8555 is available in Green SOT-23-5, SOIC-8 and MSOP-8 packages. The SGM8556 is available in Green SOIC-8 and MSOP-8 packages. They are specified over the extended industrial temperature range (-40°C to +125°C).

FEATURES

- **Low Offset Voltage: 90 μ V (MAX)**
- **Ultra-Low Input Bias Current: 30pA**
- **Low Noise Density: 21nV/ $\sqrt{\text{Hz}}$ at 1kHz**
- **Low Voltage Noise: 0.6 μ V_{P-P} at 0.1Hz to 10Hz**
- **Gain-Bandwidth Product: 3.5MHz**
- **Slew Rate: 3V/ μ s**
- **Voltage Gain: 133dB (TYP) at 5V**
- **High PSRR: 96dB (TYP)**
- **High CMRR: 98dB (TYP)**
- **Overload Recovery Time: 40 μ s (at $V_S = 5V$)**
- **Rail-to-Rail Input and Output**
- **Supply Voltage Range: 2.5V to 5.5V**
- **Low Supply Current: 950 μ A/Amplifier (TYP)**
- **No External Capacitors Required**
- **-40°C to +125°C Operating Temperature Range**
- **Small Packaging:**
 - SGM8555 Available in Green SOT-23-5, SOIC-8 and MSOP-8 Packages
 - SGM8556 Available in Green SOIC-8 and MSOP-8 Packages

APPLICATIONS

Pressure Sensors
Temperature Measurements
Precision Current Sensing
Electronic Scales
Strain Gauge Amplifiers
Handheld Test Equipment
Thermocouple Amplifiers
Medical Instrumentation

PACKAGE/ORDERING INFORMATION

MODEL	PACKAGE DESCRIPTION	SPECIFIED TEMPERATURE RANGE	ORDERING NUMBER	PACKAGE MARKING	PACKING OPTION
SGM8555	SOT-23-5	-40°C to +125°C	SGM8555XN5G/TR	S05XX	Tape and Reel, 3000
	SOIC-8	-40°C to +125°C	SGM8555XS8G/TR	SGM8555XS8 XXXXX	Tape and Reel, 2500
	MSOP-8	-40°C to +125°C	SGM8555XMS8G/TR	SGM8555 XMS8 XXXXX	Tape and Reel, 4000
SGM8556	SOIC-8	-40°C to +125°C	SGM8556XS8G/TR	SGM8556XS8 XXXXX	Tape and Reel, 2500
	MSOP-8	-40°C to +125°C	SGM8556XMS8G/TR	SGM8556 XMS8 XXXXX	Tape and Reel, 4000

MARKING INFORMATION

NOTE: XX = Date Code. XXXXX = Date Code and Vendor Code.

SOT-23-5

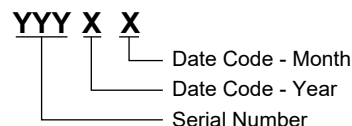

SOIC-8/MSOP-8

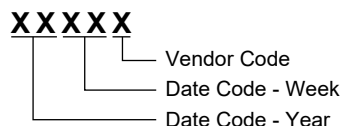

Green (RoHS & HSF): SG Micro Corp defines "Green" to mean Pb-Free (RoHS compatible) and free of halogen substances. If you have additional comments or questions, please contact your SGMICRO representative directly.

ABSOLUTE MAXIMUM RATINGS

- Supply Voltage.....6V
- Input Voltage Range -Vs to (+Vs) + 0.1V
- Differential Input Voltage Range -5V to 5V
- Junction Temperature+150°C
- Storage Temperature Range.....-65°C to +150°C
- Lead Temperature (Soldering, 10s)+260°C
- ESD Susceptibility
- HBM..... 8000V
- MM..... 400V

RECOMMENDED OPERATING CONDITIONS

- Supply Voltage Range2.5V to 5.5V
- Operating Temperature Range-40°C to +125°C

OVERSTRESS CAUTION

Stresses beyond those listed in Absolute Maximum Ratings may cause permanent damage to the device. Exposure to absolute maximum rating conditions for extended periods

may affect reliability. Functional operation of the device at any conditions beyond those indicated in the Recommended Operating Conditions section is not implied.

ESD SENSITIVITY CAUTION

This integrated circuit can be damaged if ESD protections are not considered carefully. SGMICRO recommends that all integrated circuits be handled with appropriate precautions. Failure to observe proper handling and installation procedures can cause damage. ESD damage can range from subtle performance degradation to complete device failure. Precision integrated circuits may be more susceptible to damage because even small parametric changes could cause the device not to meet the published specifications.

DISCLAIMER

SG Micro Corp reserves the right to make any change in circuit design, or specifications without prior notice.

PIN CONFIGURATIONS

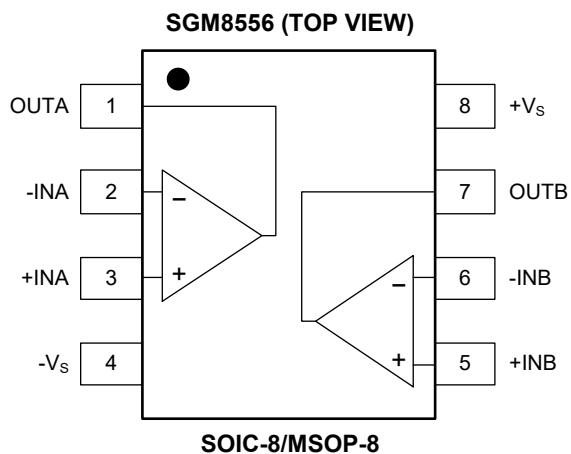
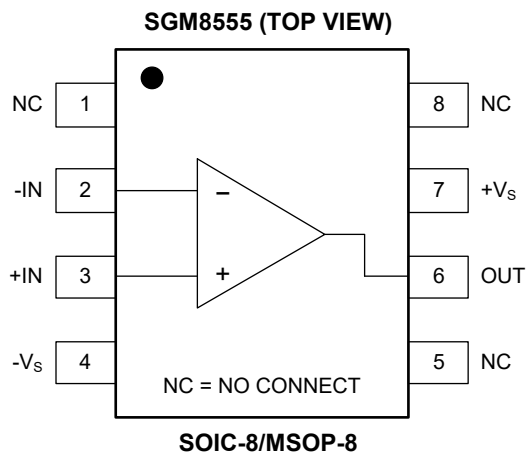
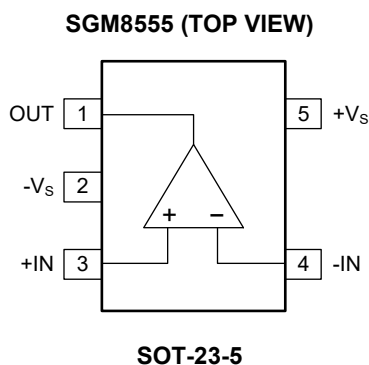

ELECTRICAL CHARACTERISTICS

($V_S = 5V$, $V_{CM} = 2.5V$, $V_{OUT} = 2.5V$, Full = $-40^{\circ}C$ to $+125^{\circ}C$, typical values are at $T_A = +25^{\circ}C$, unless otherwise noted.)

PARAMETER		CONDITIONS	TEMP	MIN	TYP	MAX	UNITS
Input Characteristics							
Input Offset Voltage (V_{OS})		$V_{CM} = V_S/2$	+25°C		32	90	μV
			Full			150	
Input Bias Current (I_b)			+25°C		30		pA
Input Offset Current (I_{OS})			+25°C		30		pA
Input Voltage Range			+25°C	0		5	V
Common Mode Rejection Ratio ⁽¹⁾ (CMRR)		$V_{CM} = 0V$ to V_S	+25°C	90	98		dB
			Full	79			
Open-Loop Voltage Gain (A_{OL})		$V_{CM} = V_S/2$, $R_L = 10k\Omega$	+25°C	109	133		dB
			Full	106			
Input Offset Voltage Drift ($\Delta V_{OS}/\Delta T$)			Full		50		nV/°C
Output Characteristics							
Output Voltage High (V_{OH})		$V_{CM} = V_S/2$, $R_L = 10k\Omega$ to GND	+25°C		13	19	mV
			Full			26	
Output Voltage Low (V_{OL})		$V_{CM} = V_S/2$, $R_L = 10k\Omega$ to V_S	+25°C		11	19	mV
			Full			26	
Short-Circuit Current	I_{SOURCE}	$V_{CM} = V_S/2$, $R_L = 10\Omega$ to $V_S/2$	+25°C	31	50		mA
			Full	22			
	I_{SINK}	$V_{CM} = V_S/2$, $R_L = 10\Omega$ to $V_S/2$	+25°C	38	61		
			Full	22			
Power Supply							
Power Supply Rejection Ratio ⁽¹⁾ (PSRR)		$V_S = 2.5V$ to $5.5V$, $V_{CM} = V_S/2$	+25°C	87	96		dB
			Full	84			
Quiescent Current/Amplifier (I_Q)		$V_{CM} = 0.5V$, $I_{OUT} = 0mA$	+25°C		950	1300	μA
			Full			1650	
Dynamic Performance							
Gain-Bandwidth Product (GBP)		$A_V = +100$, $R_F = 10k\Omega$, $R_G = 100\Omega$, $V_{CM} = V_S/2$	+25°C		3.5		MHz
Phase Margin		$A_V = +100$, $R_F = 10k\Omega$, $R_G = 100\Omega$, $V_{CM} = V_S/2$	+25°C		64		°
Gain Margin		$A_V = +100$, $R_F = 10k\Omega$, $R_G = 100\Omega$, $V_{CM} = V_S/2$	+25°C		-13		dB
Slew Rate (SR)	Up	$A_V = +1$, $R_L = 10k\Omega$, $C_L = 100pF$, 2V output step	+25°C		3		V/μs
	Down				3.5		
Overload Recovery Time	Up	$V_{IN} \times \text{Gain} = V_S$, $R_F = 10k\Omega$, $R_G = 100\Omega$, $R_L = 10k\Omega$, $A_V = -100$, $V_{IN} = 200mV$	+25°C		40		μs
	Down				36		
Noise Performance							
Input Voltage Noise ($e_{n,P-P}$)		0.1Hz to 10Hz	+25°C		0.6		μV _{P-P}
Input Voltage Noise Density (e_n)		$f = 1kHz$, $V_{CM} = V_S/2$	+25°C		21		nV/ \sqrt{Hz}
		$f = 12kHz$, $V_{CM} = V_S/2$	+25°C		10		

NOTE: 1. PSRR and CMRR are affected by the matching between external gain-setting resistor ratios.

ELECTRICAL CHARACTERISTICS (continued)

($V_S = 2.5V$, $V_{CM} = 1.25V$, $V_{OUT} = 1.25V$, Full = $-40^{\circ}C$ to $+125^{\circ}C$, typical values are at $T_A = +25^{\circ}C$, unless otherwise noted.)

PARAMETER		CONDITIONS	TEMP	MIN	TYP	MAX	UNITS
Input Characteristics							
Input Offset Voltage (V_{OS})		$V_{CM} = V_S/2$	+25°C		5	30	μV
			Full			110	
Input Bias Current (I_b)			+25°C		30		pA
Input Offset Current (I_{OS})			+25°C		30		pA
Input Voltage Range			+25°C	0		2.5	V
Common Mode Rejection Ratio ⁽¹⁾ (CMRR)		$V_{CM} = 0V$ to V_S	+25°C	86	94		dB
			Full	73			
Open-Loop Voltage Gain (A_{OL})		$V_{CM} = V_S/2$, $R_L = 10k\Omega$	+25°C	108	130		dB
			Full	105			
Input Offset Voltage Drift ($\Delta V_{OS}/\Delta T$)			Full		50		nV/°C
Output Characteristics							
Output Voltage High (V_{OH})		$V_{CM} = V_S/2$, $R_L = 10k\Omega$ to GND	+25°C		6.5	12	mV
			Full			15	
Output Voltage Low (V_{OL})		$V_{CM} = V_S/2$, $R_L = 10k\Omega$ to V_S	+25°C		6.5	13	mV
			Full			16	
Short-Circuit Current	I_{SOURCE}	$V_{CM} = V_S/2$, $R_L = 10\Omega$ to $V_S/2$	+25°C	20	30		mA
			Full	15			
	I_{SINK}	$V_{CM} = V_S/2$, $R_L = 10\Omega$ to $V_S/2$	+25°C	28	39		
			Full	17			
Power Supply							
Power Supply Rejection Ratio ⁽¹⁾ (PSRR)		$V_S = 2.5V$ to $5.5V$, $V_{CM} = V_S/2$	+25°C	87	96		dB
			Full	84			
Quiescent Current/Amplifier (I_Q)		$V_{CM} = 0.5V$, $I_{OUT} = 0mA$	+25°C		950	1300	μA
			Full			1650	
Dynamic Performance							
Gain-Bandwidth Product (GBP)		$A_V = +100$, $R_F = 10k\Omega$, $R_G = 100\Omega$, $V_{CM} = V_S/2$	+25°C		4.5		MHz
Phase Margin		$A_V = +100$, $R_F = 10k\Omega$, $R_G = 100\Omega$, $V_{CM} = V_S/2$	+25°C		59		°
Gain Margin		$A_V = +100$, $R_F = 10k\Omega$, $R_G = 100\Omega$, $V_{CM} = V_S/2$	+25°C		-11		dB
Slew Rate (SR)	Up	$A_V = +1$, $R_L = 10k\Omega$, $C_L = 100pF$, 2V output step	+25°C		3		V/μs
	Down				3.5		
Overload Recovery Time	Up	$V_{IN} \times \text{Gain} = V_S$, $R_F = 10k\Omega$, $R_G = 100\Omega$, $R_L = 10k\Omega$, $A_V = -100$, $V_{IN} = 200mV$	+25°C		12		μs
	Down				12		
Noise Performance							
Input Voltage Noise ($e_{n,P-P}$)		0.1Hz to 10Hz	+25°C		0.75		μV _{P-P}
Input Voltage Noise Density (e_n)		$f = 1kHz$, $V_{CM} = V_S/2$	+25°C		32		nV/ \sqrt{Hz}
		$f = 12kHz$, $V_{CM} = V_S/2$	+25°C		15		

NOTE: 1. PSRR and CMRR are affected by the matching between external gain-setting resistor ratios.

TYPICAL PERFORMANCE CHARACTERISTICS

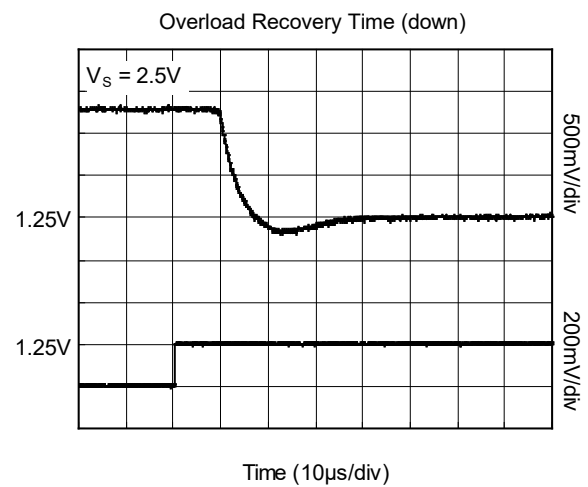
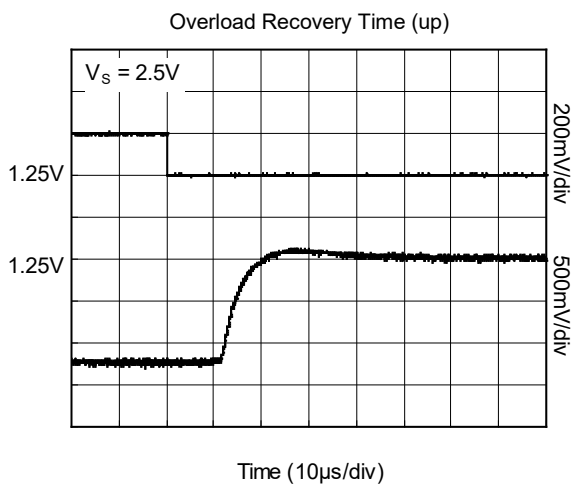
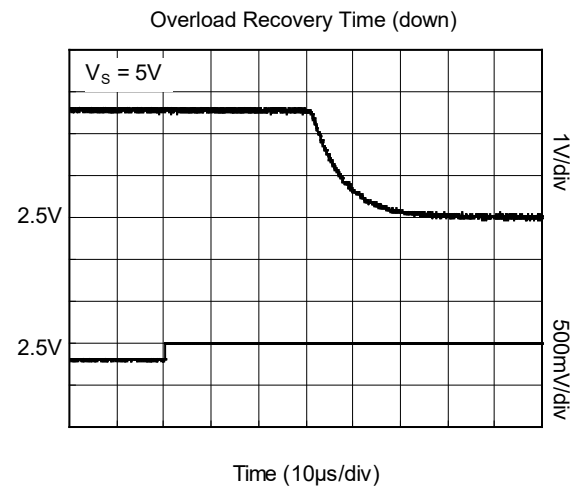
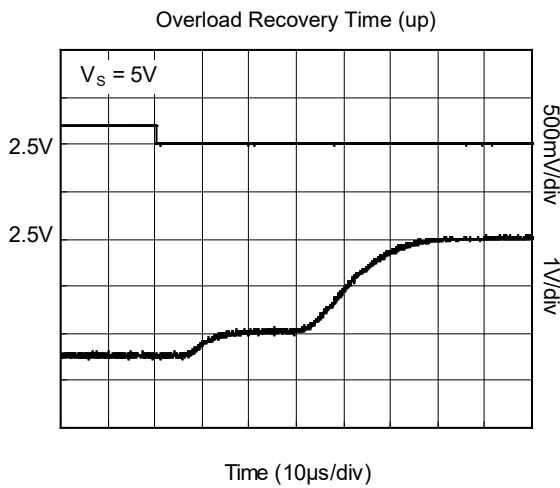
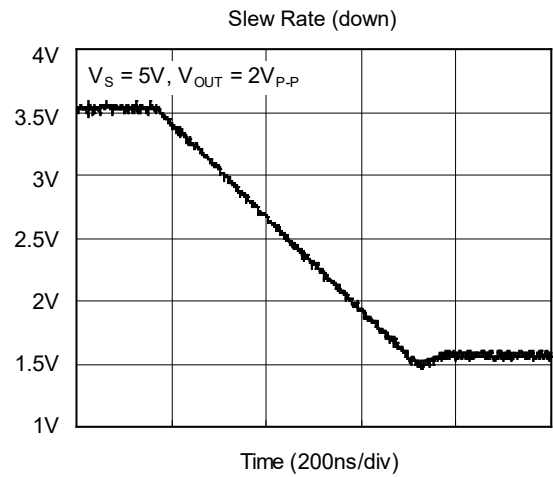
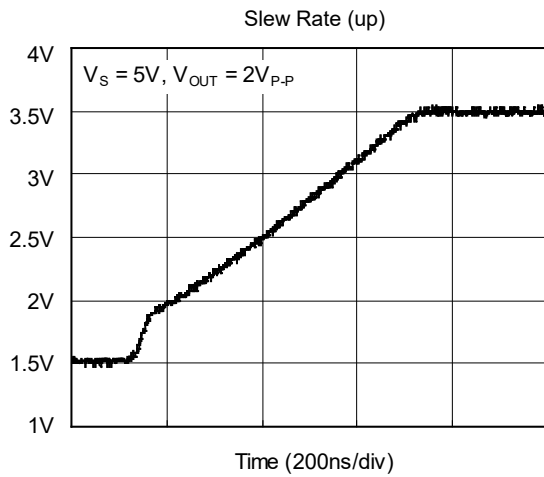

TYPICAL PERFORMANCE CHARACTERISTICS (continued)

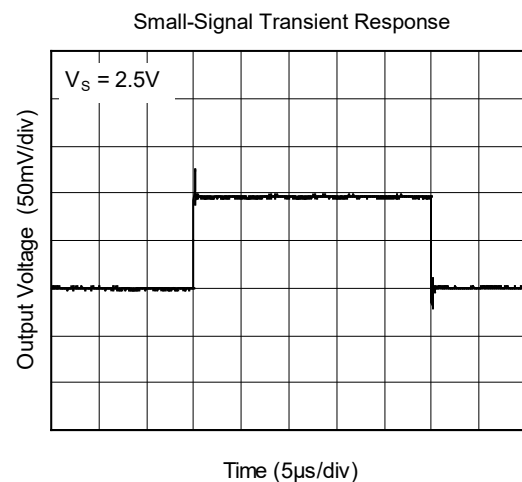
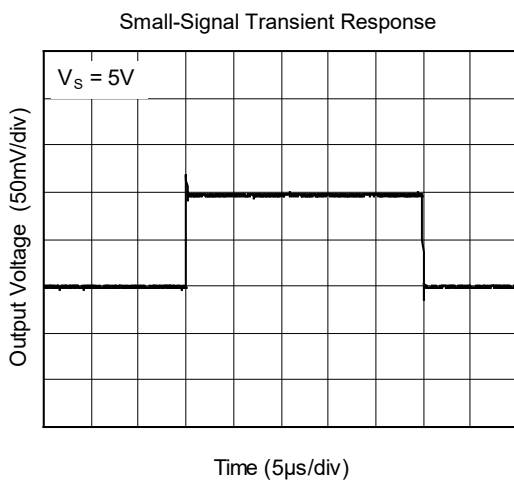
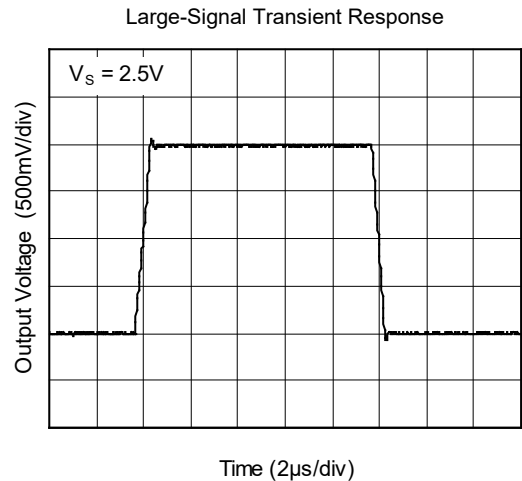
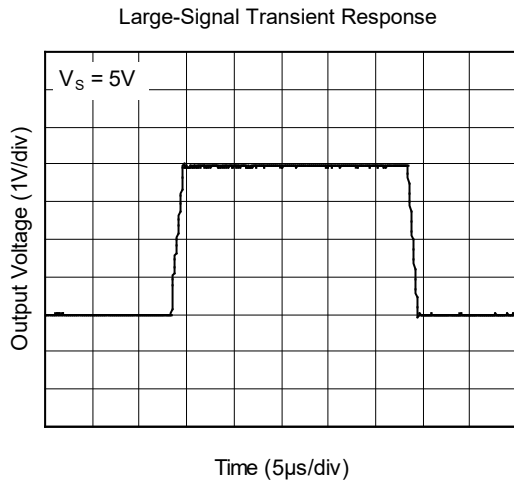
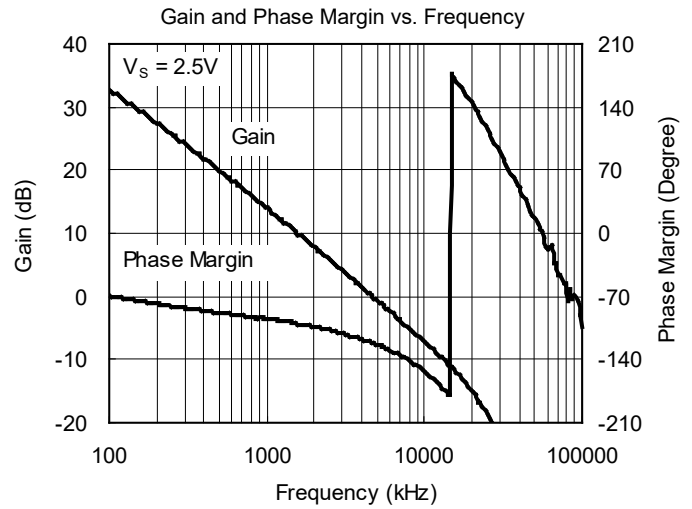
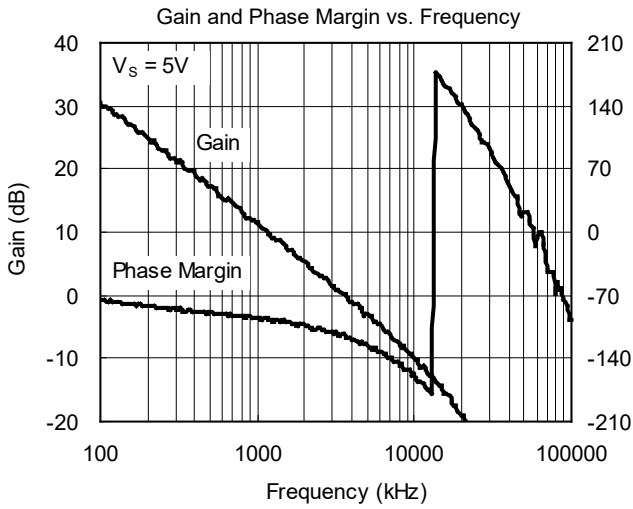

TYPICAL PERFORMANCE CHARACTERISTICS (continued)

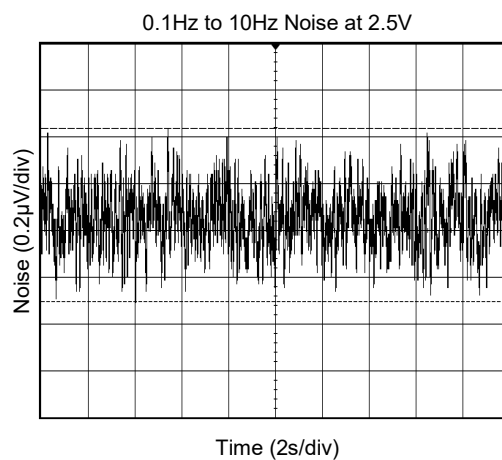
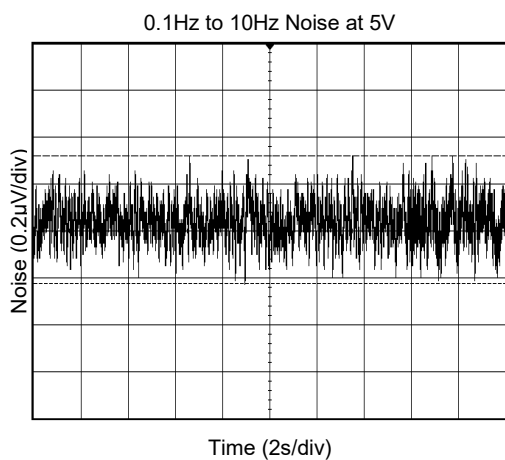

REVISION HISTORY

NOTE: Page numbers for previous revisions may differ from page numbers in the current version.

Changes from Original (APRIL 2018) to REV.A	Page
Changed from product preview to production data.....	All

PACKAGE OUTLINE DIMENSIONS

SOT-23-5

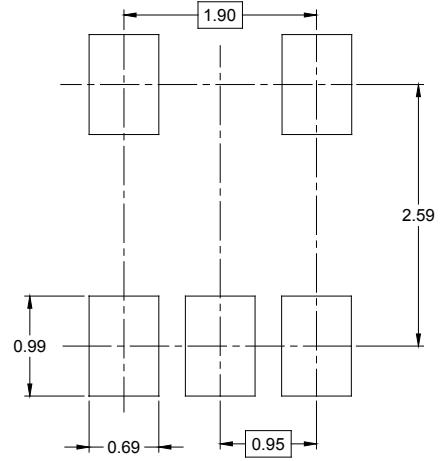

RECOMMENDED LAND PATTERN (Unit: mm)



Symbol	Dimensions In Millimeters		Dimensions In Inches	
	MIN	MAX	MIN	MAX
A	1.050	1.250	0.041	0.049
A1	0.000	0.100	0.000	0.004
A2	1.050	1.150	0.041	0.045
b	0.300	0.500	0.012	0.020
c	0.100	0.200	0.004	0.008
D	2.820	3.020	0.111	0.119
E	1.500	1.700	0.059	0.067
E1	2.650	2.950	0.104	0.116
e	0.950 BSC		0.037 BSC	
e1	1.900 BSC		0.075 BSC	
L	0.300	0.600	0.012	0.024
θ	0°	8°	0°	8°

PACKAGE OUTLINE DIMENSIONS

SOIC-8

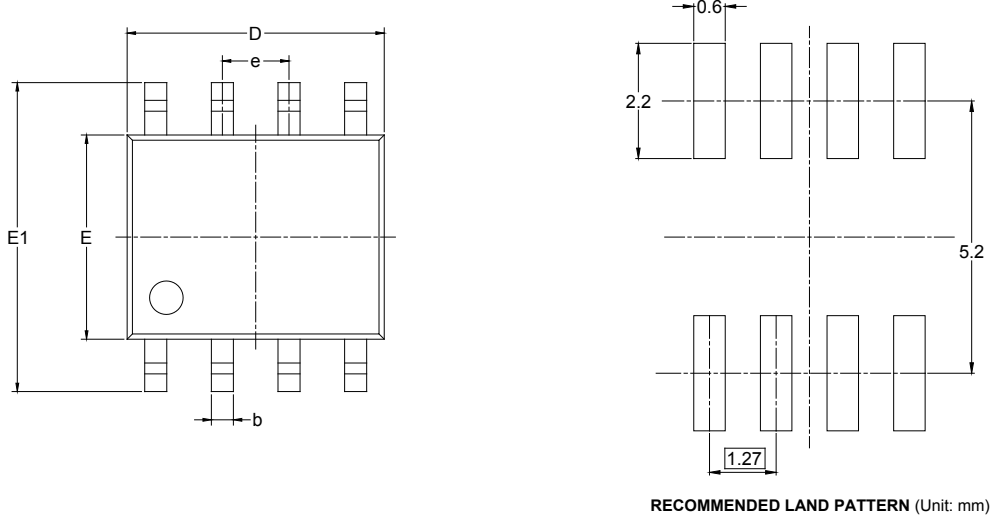

Symbol	Dimensions In Millimeters		Dimensions In Inches	
	MIN	MAX	MIN	MAX
A	1.350	1.750	0.053	0.069
A1	0.100	0.250	0.004	0.010
A2	1.350	1.550	0.053	0.061
b	0.330	0.510	0.013	0.020
c	0.170	0.250	0.006	0.010
D	4.700	5.100	0.185	0.200
E	3.800	4.000	0.150	0.157
E1	5.800	6.200	0.228	0.244
e	1.27 BSC		0.050 BSC	
L	0.400	1.270	0.016	0.050
θ	0°	8°	0°	8°

PACKAGE OUTLINE DIMENSIONS

MSOP-8

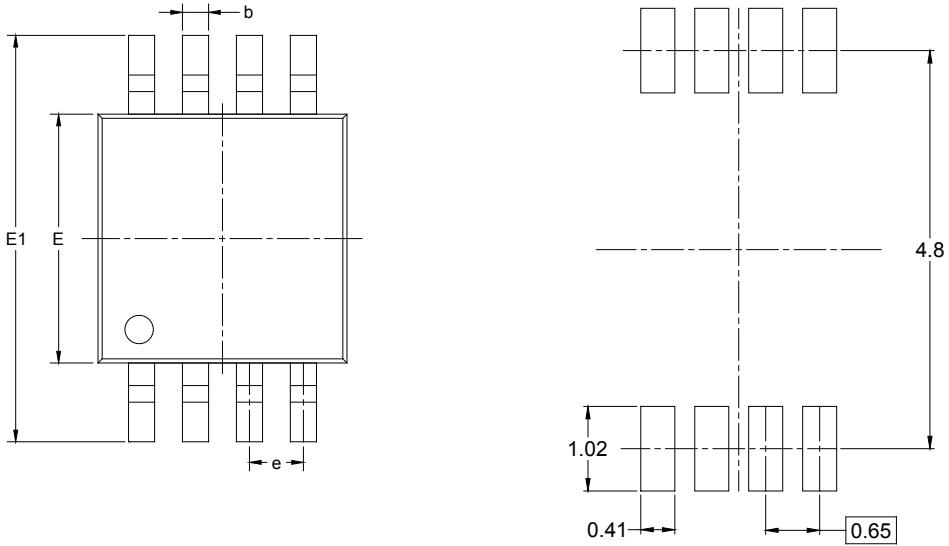

RECOMMENDED LAND PATTERN (Unit: mm)

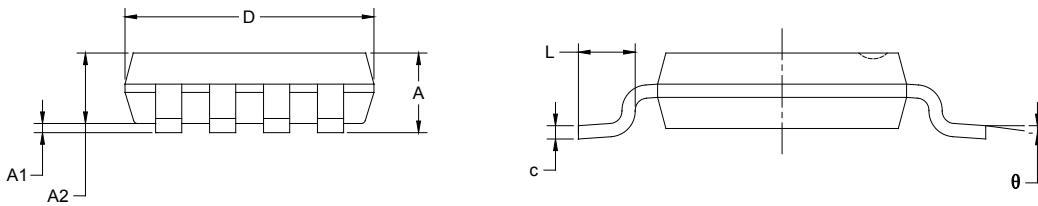

Symbol	Dimensions In Millimeters		Dimensions In Inches	
	MIN	MAX	MIN	MAX
A	0.820	1.100	0.032	0.043
A1	0.020	0.150	0.001	0.006
A2	0.750	0.950	0.030	0.037
b	0.250	0.380	0.010	0.015
c	0.090	0.230	0.004	0.009
D	2.900	3.100	0.114	0.122
E	2.900	3.100	0.114	0.122
E1	4.750	5.050	0.187	0.199
e	0.650 BSC		0.026 BSC	
L	0.400	0.800	0.016	0.031
θ	0°	6°	0°	6°

PACKAGE INFORMATION

TAPE AND REEL INFORMATION

REEL DIMENSIONS



TAPE DIMENSIONS



NOTE: The picture is only for reference. Please make the object as the standard.

KEY PARAMETER LIST OF TAPE AND REEL

Package Type	Reel Diameter	Reel Width W1 (mm)	A0 (mm)	B0 (mm)	K0 (mm)	P0 (mm)	P1 (mm)	P2 (mm)	W (mm)	Pin1 Quadrant
SOT-23-5	7"	9.5	3.20	3.20	1.40	4.0	4.0	2.0	8.0	Q3
SOIC-8	13"	12.4	6.40	5.40	2.10	4.0	8.0	2.0	12.0	Q1
MSOP-8	13"	12.4	5.20	3.30	1.50	4.0	8.0	2.0	12.0	Q1

DD0001

PACKAGE INFORMATION

CARTON BOX DIMENSIONS



NOTE: The picture is only for reference. Please make the object as the standard.

KEY PARAMETER LIST OF CARTON BOX

Reel Type	Length (mm)	Width (mm)	Height (mm)	Pizza/Carton
7" (Option)	368	227	224	8
7"	442	410	224	18
13"	386	280	370	5

DD0002