

GENERAL DESCRIPTION

The SGM820 is a high-accuracy supervisory circuit with programmable watchdog timer, which can realize the under-voltage threshold accuracy of less than 1% from -40°C to +125°C. It provides ten reset threshold voltage options for 1.8V, 2.5V, 3V, 3.3V and 5V voltage monitoring.

The nRESET delay of the SGM820 has a high-precision delay timing. Due to its accurate hysteresis, the SGM820 is very suitable for using with strict tolerance systems.

The SGM820 has a programmable watchdog timer. Users can program the timeouts through an external capacitor or the default factory settings. In addition, users can disable the watchdog through logic pins to prevent accidental timeouts during development.

The SGM820 is available in Green TDFN-3×3-8L and TDFN-2×2-8L packages. It operates over an ambient temperature range of -40°C to +125°C.

FEATURES

- **Precision Fixed Detection Options: 1.8V, 2.5V, 3V, 3.3V and 5V**
- **High-Accuracy Voltage Threshold (< 1%)**
- **Hysteresis: 0.5% (TYP)**
- **Supply Voltage Range: 1.6V to 6.5V**
- **Ultra-Low Supply Current: 1.2µA (TYP)**
- **Factory-Set ±15% Accuracy Watchdog Timeout and Reset Delays**
- **User-Programmable Watchdog Timeout**
- **Watchdog Disable Function**
- **Manual Reset Input (nMR)**
- **Open-Drain nRESET Output**
- **-40°C to +125°C Operating Temperature Range**
- **Available in Green TDFN-3×3-8L and TDFN-2×2-8L Packages**

APPLICATIONS

- Safety Applications
- Precision Industrial System Controllers
- DSPs, FPGAs and ASICs

TYPICAL APPLICATION

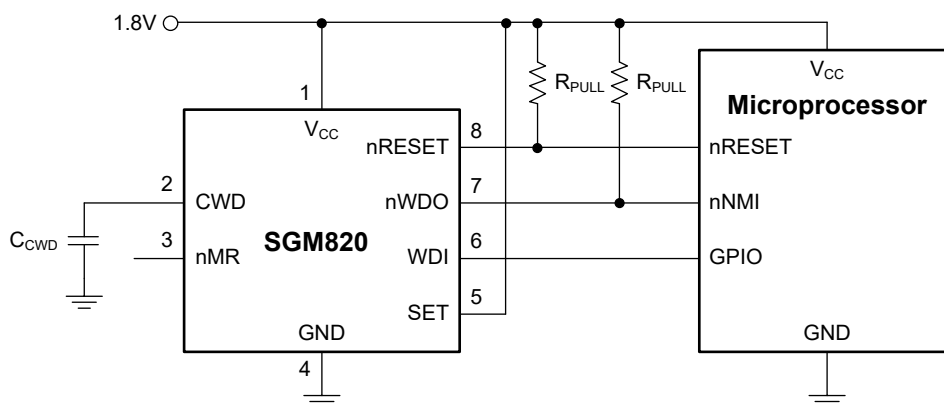

PACKAGE/ORDERING INFORMATION

MODEL	UNDER-VOLTAGE THRESHOLD (V)	PACKAGE DESCRIPTION	ORDERING NUMBER	PACKAGE MARKING	PACKING OPTION
SGM820A-4.8	4.800	TDFN-3×3-8L	SGM820A-4.8XTDB8G/TR	SGM MKBDB XXXXX	Tape and Reel, 4000
	4.800	TDFN-2×2-8L	SGM820A-4.8XTDE8G/TR	MJ1 XXXX	Tape and Reel, 3000
SGM820B-4.8	4.800	TDFN-3×3-8L	SGM820B-4.8XTDB8G/TR	SGM ML5DB XXXXX	Tape and Reel, 4000
	4.800	TDFN-2×2-8L	SGM820B-4.8XTDE8G/TR	MJB XXXX	Tape and Reel, 3000
SGM820A-4.6	4.650	TDFN-3×3-8L	SGM820A-4.6XTDB8G/TR	SGM MKADB XXXXX	Tape and Reel, 4000
	4.650	TDFN-2×2-8L	SGM820A-4.6XTDE8G/TR	MJ0 XXXX	Tape and Reel, 3000
SGM820B-4.6	4.650	TDFN-3×3-8L	SGM820B-4.6XTDB8G/TR	SGM ML4DB XXXXX	Tape and Reel, 4000
	4.650	TDFN-2×2-8L	SGM820B-4.6XTDE8G/TR	MJA XXXX	Tape and Reel, 3000
SGM820A-3.1	3.168	TDFN-3×3-8L	SGM820A-3.1XTDB8G/TR	SGM MK9DB XXXXX	Tape and Reel, 4000
	3.168	TDFN-2×2-8L	SGM820A-3.1XTDE8G/TR	MIF XXXX	Tape and Reel, 3000
SGM820B-3.1	3.168	TDFN-3×3-8L	SGM820B-3.1XTDB8G/TR	SGM ML3DB XXXXX	Tape and Reel, 4000
	3.168	TDFN-2×2-8L	SGM820B-3.1XTDE8G/TR	MJ9 XXXX	Tape and Reel, 3000
SGM820A-3.0	3.069	TDFN-3×3-8L	SGM820A-3.0XTDB8G/TR	SGM MK8DB XXXXX	Tape and Reel, 4000
	3.069	TDFN-2×2-8L	SGM820A-3.0XTDE8G/TR	MIE XXXX	Tape and Reel, 3000
SGM820B-3.0	3.069	TDFN-3×3-8L	SGM820B-3.0XTDB8G/TR	SGM ML2DB XXXXX	Tape and Reel, 4000
	3.069	TDFN-2×2-8L	SGM820B-3.0XTDE8G/TR	MJ8 XXXX	Tape and Reel, 3000
SGM820A-2.8	2.880	TDFN-3×3-8L	SGM820A-2.8XTDB8G/TR	SGM MK7DB XXXXX	Tape and Reel, 4000
	2.880	TDFN-2×2-8L	SGM820A-2.8XTDE8G/TR	MID XXXX	Tape and Reel, 3000
SGM820B-2.8	2.880	TDFN-3×3-8L	SGM820B-2.8XTDB8G/TR	SGM ML1DB XXXXX	Tape and Reel, 4000
	2.880	TDFN-2×2-8L	SGM820B-2.8XTDE8G/TR	MJ7 XXXX	Tape and Reel, 3000

PACKAGE/ORDERING INFORMATION (continued)

MODEL	UNDER-VOLTAGE THRESHOLD (V)	PACKAGE DESCRIPTION	ORDERING NUMBER	PACKAGE MARKING	PACKING OPTION
SGM820A-2.7	2.790	TDFN-3×3-8L	SGM820A-2.7XTDB8G/TR	SGM MK6DB XXXXX	Tape and Reel, 4000
	2.790	TDFN-2×2-8L	SGM820A-2.7XTDE8G/TR	MIC XXXX	Tape and Reel, 3000
SGM820B-2.7	2.790	TDFN-3×3-8L	SGM820B-2.7XTDB8G/TR	SGM ML0DB XXXXX	Tape and Reel, 4000
	2.790	TDFN-2×2-8L	SGM820B-2.7XTDE8G/TR	MJ6 XXXX	Tape and Reel, 3000
SGM820A-2.4	2.400	TDFN-3×3-8L	SGM820A-2.4XTDB8G/TR	SGM MK5DB XXXXX	Tape and Reel, 4000
	2.400	TDFN-2×2-8L	SGM820A-2.4XTDE8G/TR	MIB XXXX	Tape and Reel, 3000
SGM820B-2.4	2.400	TDFN-3×3-8L	SGM820B-2.4XTDB8G/TR	SGM MKFDB XXXXX	Tape and Reel, 4000
	2.400	TDFN-2×2-8L	SGM820B-2.4XTDE8G/TR	MJ5 XXXX	Tape and Reel, 3000
SGM820A-2.3	2.325	TDFN-3×3-8L	SGM820A-2.3XTDB8G/TR	SGM MK4DB XXXXX	Tape and Reel, 4000
	2.325	TDFN-2×2-8L	SGM820A-2.3XTDE8G/TR	MI9 XXXX	Tape and Reel, 3000
SGM820B-2.3	2.325	TDFN-3×3-8L	SGM820B-2.3XTDB8G/TR	SGM MKEDB XXXXX	Tape and Reel, 4000
	2.325	TDFN-2×2-8L	SGM820B-2.3XTDE8G/TR	MJ4 XXXX	Tape and Reel, 3000
SGM820A-1.7	1.728	TDFN-3×3-8L	SGM820A-1.7XTDB8G/TR	SGM MK2DB XXXXX	Tape and Reel, 4000
	1.728	TDFN-2×2-8L	SGM820A-1.7XTDE8G/TR	MI7 XXXX	Tape and Reel, 3000
SGM820B-1.7	1.728	TDFN-3×3-8L	SGM820B-1.7XTDB8G/TR	SGM MKDDB XXXXX	Tape and Reel, 4000
	1.728	TDFN-2×2-8L	SGM820B-1.7XTDE8G/TR	MJ3 XXXX	Tape and Reel, 3000
SGM820A-1.6	1.674	TDFN-3×3-8L	SGM820A-1.6XTDB8G/TR	SGM MK1DB XXXXX	Tape and Reel, 4000
	1.674	TDFN-2×2-8L	SGM820A-1.6XTDE8G/TR	MI6 XXXX	Tape and Reel, 3000
SGM820B-1.6	1.674	TDFN-3×3-8L	SGM820B-1.6XTDB8G/TR	SGM MKCDB XXXXX	Tape and Reel, 4000
	1.674	TDFN-2×2-8L	SGM820B-1.6XTDE8G/TR	MJ2 XXXX	Tape and Reel, 3000

NOTE:

SGM820A-X provide standard user-programming watchdog timeout: $t_{WD_standard} (ms) = 3.33 \times C_{CWD} (nF) + 0.28 (ms)$ SGM820B-X provide extended user-programming watchdog timeout: $t_{WD_extended} (ms) = 78.3 \times C_{CWD} (nF) + 51 (ms)$

PACKAGE/ORDERING INFORMATION (continued)

MARKING INFORMATION

NOTE: XXXXX = Date Code, Trace Code and Vendor Code. XXXX = Date Code and Trace Code.

TDFN-3×3-8L

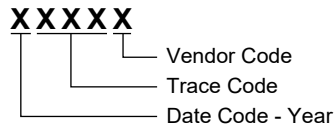

TDFN-2×2-8L

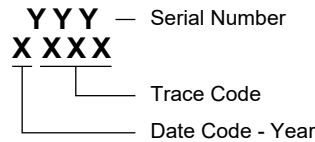

Green (RoHS & HSF): SG Micro Corp defines "Green" to mean Pb-Free (RoHS compatible) and free of halogen substances. If you have additional comments or questions, please contact your SGMICRO representative directly.

ABSOLUTE MAXIMUM RATINGS

Supply Voltage Range, V_{CC}	-0.3V to 7V
Output Voltage Range	
nRESET, nWDO	-0.3V to 7V
Voltage Ranges	
SET, WDI, nMR.....	-0.3V to 7V
CWD.....	-0.3V to $V_{CC} + 0.3V$
Output Pin Current	
nRESET, nWDO	±20mA
Input Current (All Pins)	±20mA
Junction Temperature.....	+150°C
Storage Temperature Range	-65°C to +150°C
Lead Temperature (Soldering, 10s).....	+260°C
ESD Susceptibility	
HBM.....	4000V
CDM	1000V

RECOMMENDED OPERATING CONDITIONS

Supply Pin Voltage, V_{CC}	1.6V to 6.5V
SET Pin Voltage, V_{SET}	0V to 6.5V
Watchdog Timing Capacitor, C_{CWD}	0.1nF to 1000nF ⁽¹⁾
Pull-Up Resistor to V_{CC} , CWD.....	9kΩ to 11kΩ
Pull-Up Resistor, nRESET and nWDO, R_{PU}	1kΩ to 100kΩ
nRESET Pin Current, I_{nRESET}	10mA
Watchdog Output Current, I_{nWDO}	10mA
Junction Temperature Range.....	-40°C to +125°C
Ambient Temperature Range.....	-40°C to +125°C

NOTE:

1. It is recommended to use the standard timing with a C_{CWD} capacitor from 0.1nF to 1000nF, and offer t_{WD_TYP} from 0.613ms to 3.33s accordingly; If using extended timing, offer t_{WD_TYP} from 0.613ms to 3.33s accordingly.

OVERSTRESS CAUTION

Stresses beyond those listed in Absolute Maximum Ratings may cause permanent damage to the device. Exposure to absolute maximum rating conditions for extended periods may affect reliability. Functional operation of the device at any conditions beyond those indicated in the Recommended Operating Conditions section is not implied.

ESD SENSITIVITY CAUTION

This integrated circuit can be damaged if ESD protections are not considered carefully. SGMICRO recommends that all integrated circuits be handled with appropriate precautions. Failure to observe proper handling and installation procedures can cause damage. ESD damage can range from subtle performance degradation to complete device failure. Precision integrated circuits may be more susceptible to damage because even small parametric changes could cause the device not to meet the published specifications.

DISCLAIMER

SG Micro Corp reserves the right to make any change in circuit design, or specifications without prior notice.

PIN CONFIGURATIONS

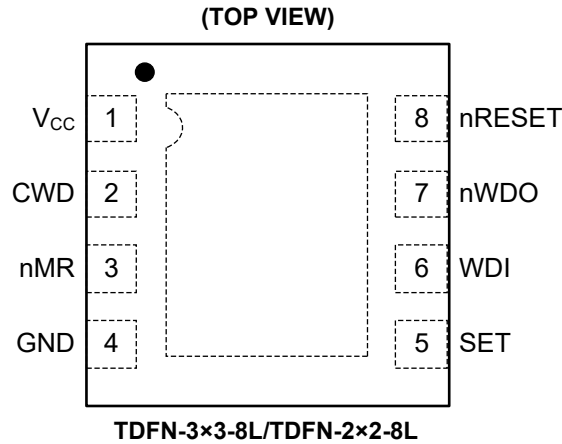

PIN DESCRIPTION

PIN	NAME	TYPE	FUNCTION
1	V _{CC}	I	Supply Voltage Pin.
2	CWD	I	Programmable Watchdog Timeout Input Pin. Connecting the CWD pin to GND via a capacitor to set the watchdog timeout. Connecting the CWD pin to V _{CC} via a 10kΩ resistor or leaving it unconnected to select the preset watchdog timeout.
3	nMR	I	Manual Reset Input Pin. It is an active-low reset input internally pulled up to V _{CC} .
4	GND	G	Ground Pin.
5	SET	I	Logic Input Pin. Connecting the SET pin to GND will disable the watchdog timer. The SET pin selects the watchdog timeouts with CWD pin.
6	WDI	I	Watchdog Input Pin. The WDI falling edge must appear within the timeout (t _{WD}) period. When nWDO or nRESET is low and the watchdog is disabled, WDI will be ignored.
7	nWDO	O	Watchdog Output Pin. If the watchdog timeout occurs, the nWDO goes low within an nRESET timeout delay (t _{RST}). Then the nWDO enters in a high-Z state
8	nRESET	O	Active-Low Reset Output Pin. nRESET remains low if V _{CC} is below the under-voltage threshold. nRESET timeout counter starts if V _{CC} is operating normally. And nRESET goes high if the counter completed.
Exposed Pad	—	G	Exposed Pad. It is internally connected to GND.

NOTE: I: Input; O: Output; G: Ground.

ELECTRICAL CHARACTERISTICS

($V_{ITN} + V_{HYS} \leq V_{CC} \leq 6.5V$, Full = $-40^{\circ}C$ to $+125^{\circ}C$, the open-drain pull-up resistors are 10k Ω for each output, unless otherwise noted.)

PARAMETER	SYMBOL	CONDITIONS	TEMP	MIN	TYP	MAX	UNITS
General Characteristics							
Power Supply Voltage	$V_{CC}^{(1)(2)}$		Full	1.6		6.5	V
Supply Current	I_{CC}		Full		1.2	3.3	μA
Reset Function							
Power-On Reset Voltage	$V_{POR}^{(1)}$	$I_{nRESET} = 15\mu A$, $V_{OL(MAX)} = 0.25V$	Full			0.8	V
Under-Voltage Threshold	V_{ITN}	SGM820A/B-4.8, V_{CC} falling	Full	4.757	4.800	4.843	V
		SGM820A/B-4.6, V_{CC} falling	Full	4.608	4.650	4.692	
		SGM820A/B-3.1, V_{CC} falling	Full	3.139	3.168	3.197	
		SGM820A/B-3.0, V_{CC} falling	Full	3.041	3.069	3.097	
		SGM820A/B-2.8, V_{CC} falling	Full	2.854	2.880	2.906	
		SGM820A/B-2.7, V_{CC} falling	Full	2.765	2.790	2.815	
		SGM820A/B-2.4, V_{CC} falling	Full	2.377	2.400	2.423	
		SGM820A/B-2.3, V_{CC} falling	Full	2.303	2.325	2.347	
		SGM820A/B-1.7, V_{CC} falling	Full	1.711	1.728	1.745	
SGM820A/B-1.6, V_{CC} falling	Full	1.658	1.674	1.690			
Hysteresis Voltage	V_{HYS}	V_{CC} rising	Full	$0.15\% \times V_{ITN}$	$0.50\% \times V_{ITN}$	$0.85\% \times V_{ITN}$	V
nMR Pin Internal Pull-Up Current	I_{nMR}	$V_{nMR} = 0V$	Full	520	620	720	nA
Watchdog Function							
CWD Pin Charging Current	I_{CWD}	CWD = 0.5V	Full	337	375	413	nA
CWD Pin Threshold Voltage	V_{CWD}		Full	1.180	1.210	1.245	V
nRESET, nWDO Output Low	V_{OL}	$V_{CC} = 5V$, $I_{SINK} = 3mA$	Full			0.4	V
nRESET, nWDO Output Leakage Current, Open-Drain	I_D	$V_{CC} = V_{ITN} + V_{HYS}$, $V_{nRESET} = V_{nWDO} = 6.5V$	Full			1	μA
Low-Level Input Voltage of nMR	V_{IL_nMR}		Full			0.25	V
High-Level Input Voltage of nMR	V_{IH_nMR}		Full	0.8			V
Low-Level Input Voltage of SET	V_{IL_SET}		Full			0.25	V
High-Level Input Voltage of SET	V_{IH_SET}		Full	0.8			V
Low-Level Input Voltage of WDI	V_{IL_WDI}		Full			$0.3 \times V_{CC}$	V
High-Level Input Voltage of WDI	V_{IH_WDI}		Full	$0.8 \times V_{CC}$			V

NOTES:

- When V_{CC} falls below V_{POR} , nRESET and nWDO are undefined.
- During power-on, V_{CC} must be a minimum 1.6V for at least 400 μs before nRESET correlates with V_{CC} .

TIMING REQUIREMENTS

(At $T_A = +25^\circ\text{C}$, $V_{ITN} + V_{HYS} \leq V_{CC} \leq 6.5\text{V}$, Full = -40°C to $+125^\circ\text{C}$, the open-drain pull-up resistors are $10\text{k}\Omega$ for each output, unless otherwise noted.)

PARAMETER	SYMBOL	CONDITIONS	TEMP	MIN	TYP	MAX	UNITS
General							
CWD Pin Evaluation Period	t_{INIT}		$+25^\circ\text{C}$		390		μs
Minimum nMR Pin Pulse Duration			$+25^\circ\text{C}$		1		μs
Reset Function							
nRESET Timeout Period	t_{RST}		Full	170	200	230	ms
V_{CC} to nRESET Delay	$t_{\text{RST_DEL}}$	$V_{\text{CC}} = (V_{\text{ITN}} + V_{\text{HYS}}) \times (1 + 2.5\%)$ to $V_{\text{ITN}} \times (1 - 2.5\%)$	$+25^\circ\text{C}$		90		μs
nMR to nRESET Delay	$t_{\text{MR_DEL}}$		$+25^\circ\text{C}$		700		ns
Watchdog Function							
Watchdog Timeout ⁽¹⁾	t_{WD}	CWD = NC, SET = 0 ⁽²⁾	Watchdog disabled				
		CWD = NC, SET = 1 ⁽²⁾	Full	1360	1600	1840	ms
		CWD = $10\text{k}\Omega$ to V_{CC} , SET = 0 ⁽²⁾	Watchdog disabled				
		CWD = $10\text{k}\Omega$ to V_{CC} , SET = 1 ⁽²⁾	Full	170	200	230	ms
Set-Up Time Required for Device to Respond to Changes on WDI after Being Enabled	$t_{\text{WD_SETUP}}$		$+25^\circ\text{C}$		140		μs
Minimum WDI, nMR Pin Pulse Duration			$+25^\circ\text{C}$		50		ns
WDI to nWDO Delay	$t_{\text{WD_DEL}}$		$+25^\circ\text{C}$		100		ns

NOTES:

- The fixed watchdog timing covers both standard version SGM820A-X and extended version SGM820B-X.
- SET = 0 means $V_{\text{SET}} < V_{\text{IL_SET}}$; SET = 1 means $V_{\text{SET}} > V_{\text{IH_SET}}$.

TYPICAL PERFORMANCE CHARACTERISTICS

At $T_A = +25^\circ\text{C}$, $1.6\text{V} \leq V_{CC} \leq 6.5\text{V}$, unless otherwise noted.

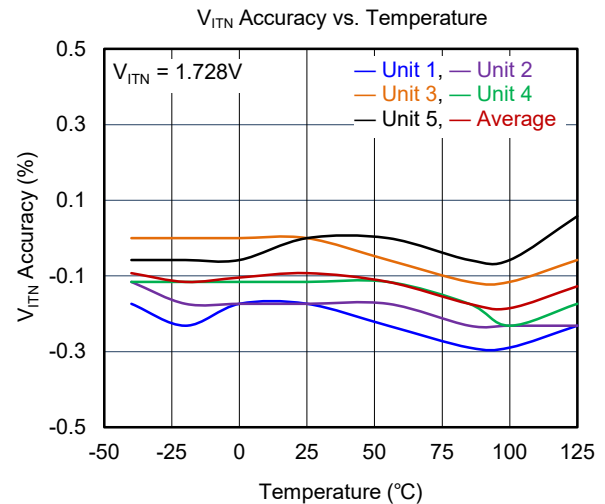
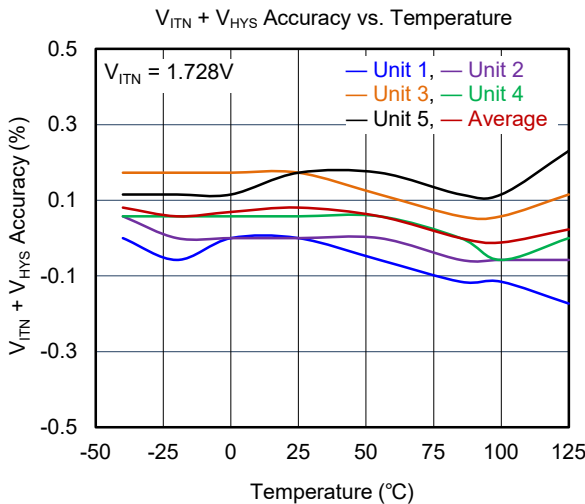
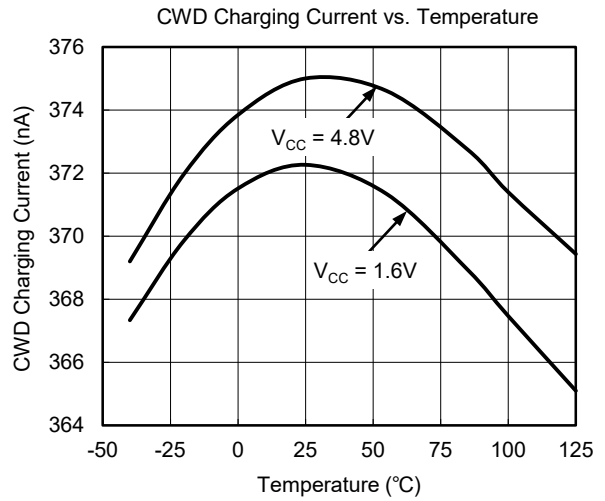
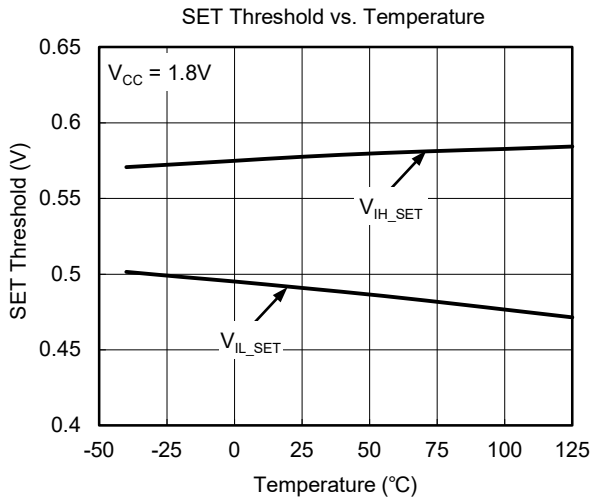
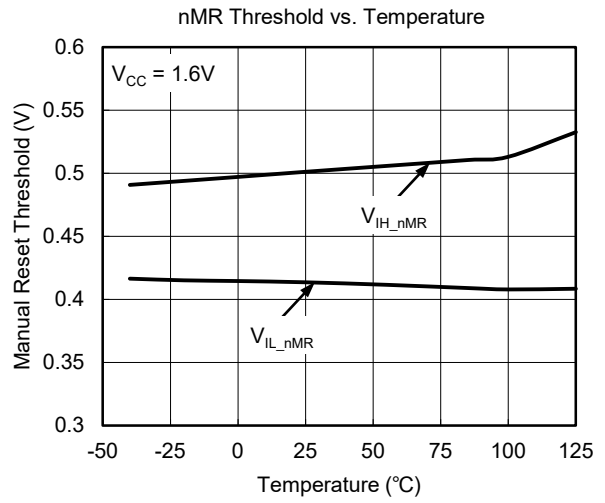
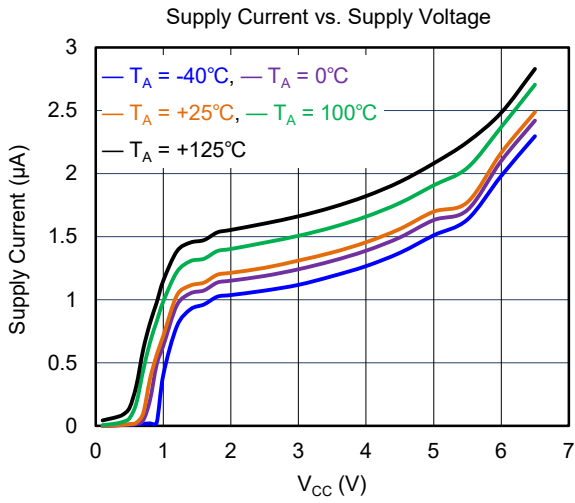

TYPICAL PERFORMANCE CHARACTERISTICS (continued)

At $T_A = +25^\circ\text{C}$, $1.6\text{V} \leq V_{CC} \leq 6.5\text{V}$, unless otherwise noted.

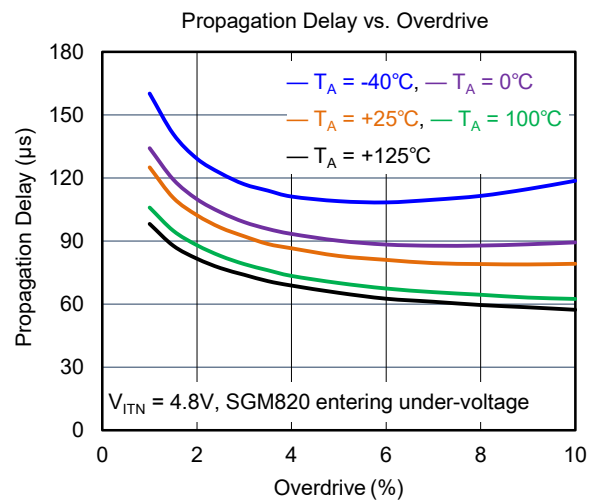
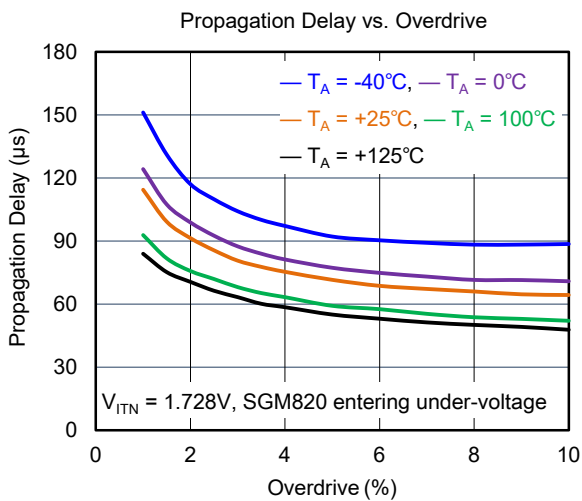
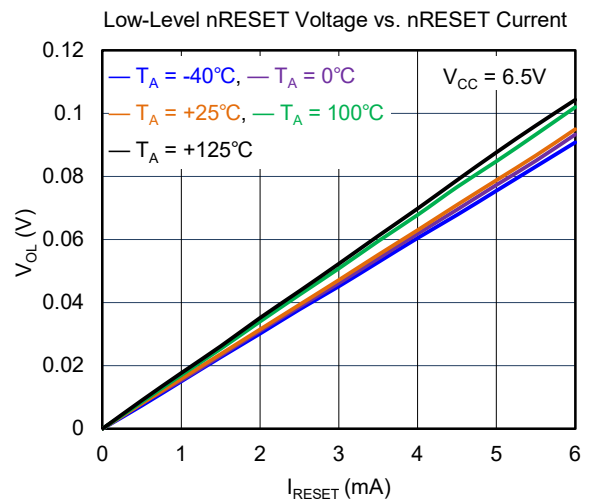
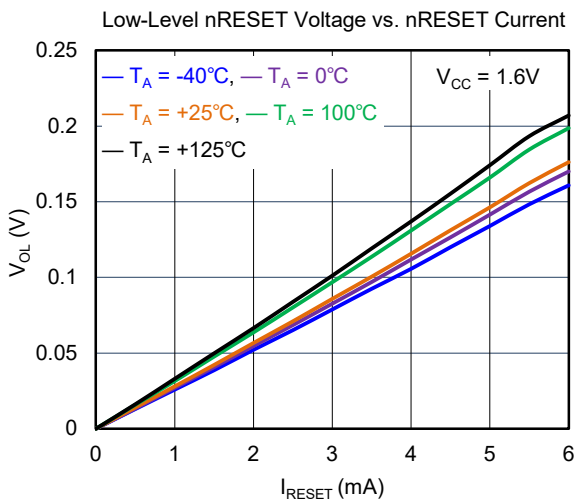
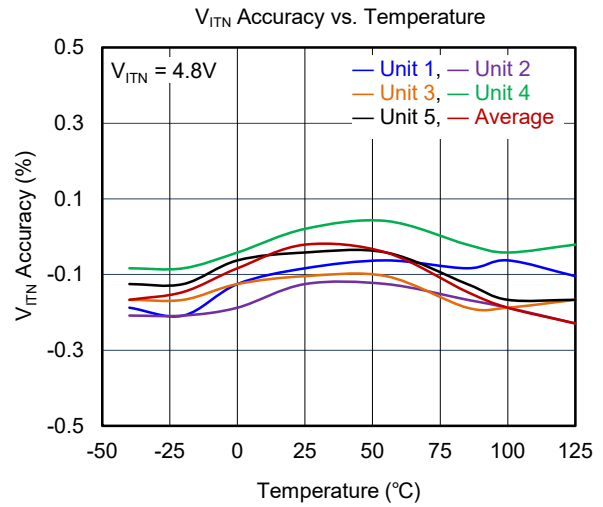
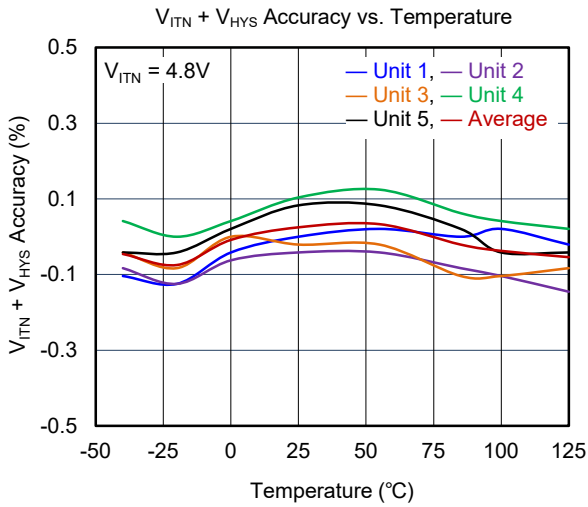

TYPICAL PERFORMANCE CHARACTERISTICS (continued)

At $T_A = +25^\circ\text{C}$, $1.6\text{V} \leq V_{CC} \leq 6.5\text{V}$, unless otherwise noted.

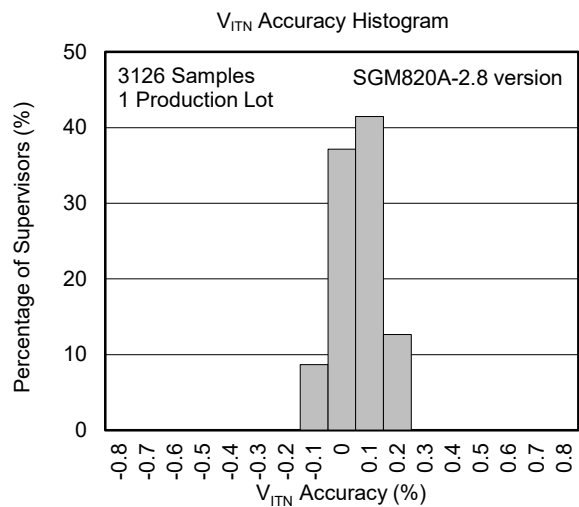
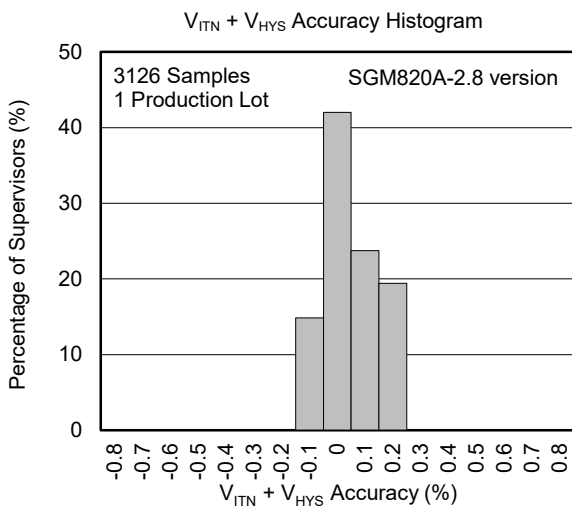
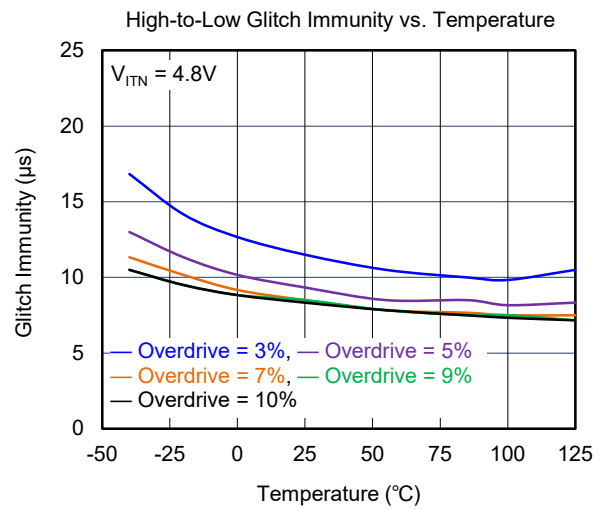
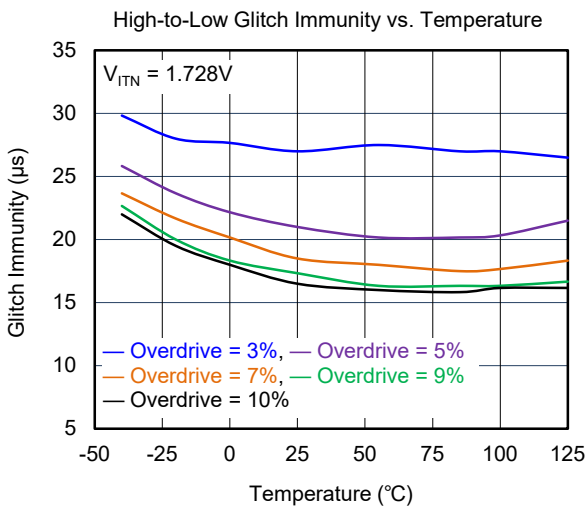
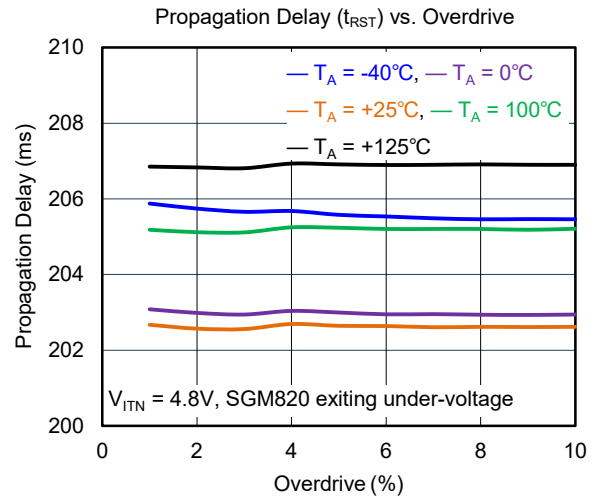
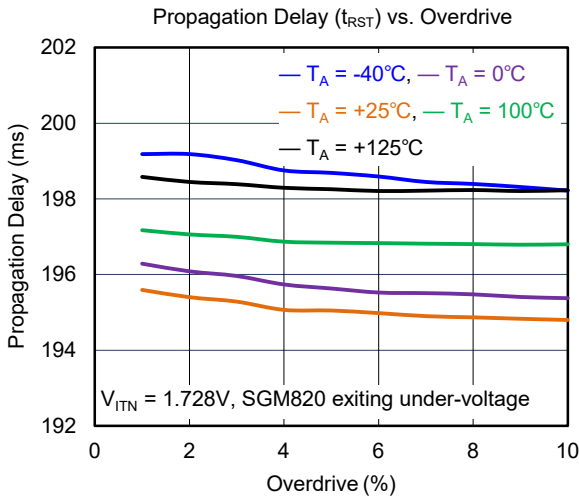

TYPICAL PERFORMANCE CHARACTERISTICS (continued)

At $T_A = +25^\circ\text{C}$, $1.6\text{V} \leq V_{CC} \leq 6.5\text{V}$, unless otherwise noted.

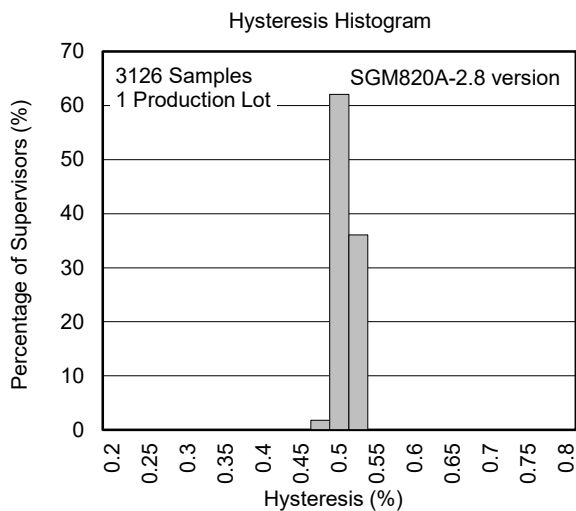

REVISION HISTORY

NOTE: Page numbers for previous revisions may differ from page numbers in the current version.

Changes from Original (JULY 2019) to REV.A	Page
Changed from product preview to production data.....	All

PACKAGE OUTLINE DIMENSIONS

TDFN-3x3-8L

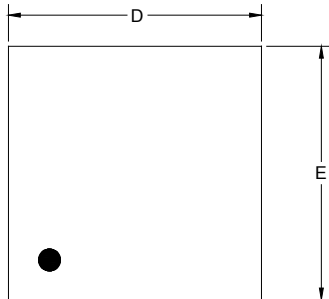

TOP VIEW

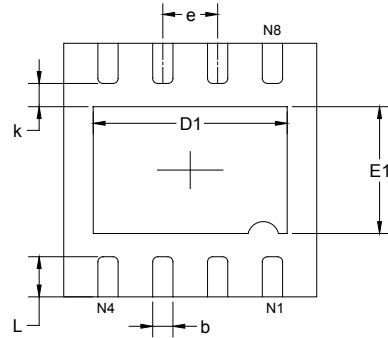

BOTTOM VIEW

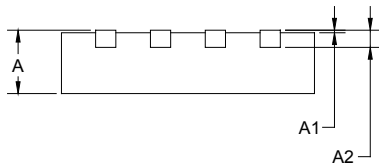

SIDE VIEW

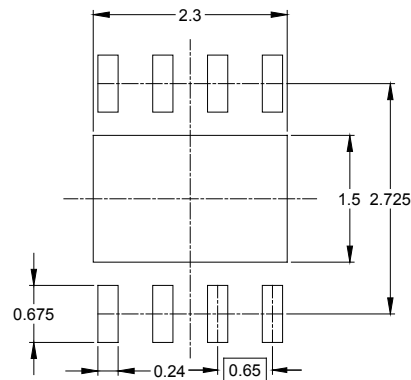

RECOMMENDED LAND PATTERN (Unit: mm)

Symbol	Dimensions In Millimeters		Dimensions In Inches	
	MIN	MAX	MIN	MAX
A	0.700	0.800	0.028	0.031
A1	0.000	0.050	0.000	0.002
A2	0.203 REF		0.008 REF	
D	2.900	3.100	0.114	0.122
D1	2.200	2.400	0.087	0.094
E	2.900	3.100	0.114	0.122
E1	1.400	1.600	0.055	0.063
k	0.200 MIN		0.008 MIN	
b	0.180	0.300	0.007	0.012
e	0.650 TYP		0.026 TYP	
L	0.375	0.575	0.015	0.023

PACKAGE OUTLINE DIMENSIONS

TDFN-2x2-8L

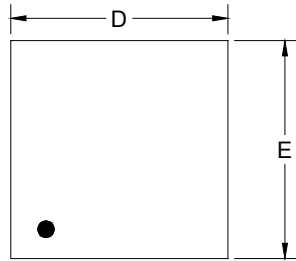

TOP VIEW

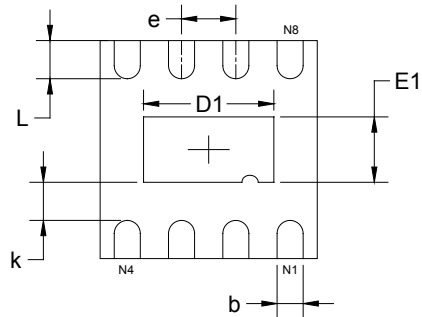

BOTTOM VIEW

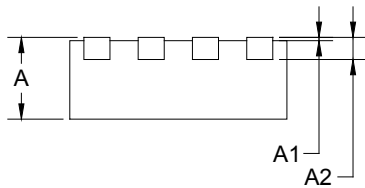

SIDE VIEW

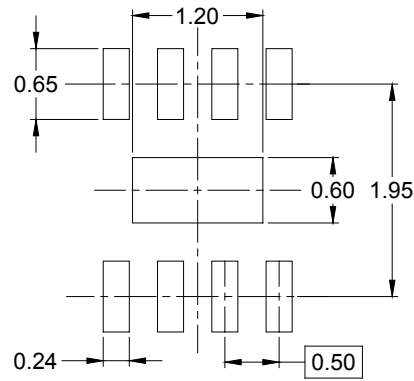

RECOMMENDED LAND PATTERN (Unit: mm)

Symbol	Dimensions In Millimeters		Dimensions In Inches	
	MIN	MAX	MIN	MAX
A	0.700	0.800	0.028	0.031
A1	0.000	0.050	0.000	0.002
A2	0.203 REF		0.008 REF	
D	1.900	2.100	0.075	0.083
D1	1.100	1.300	0.043	0.051
E	1.900	2.100	0.075	0.083
E1	0.500	0.700	0.020	0.028
k	0.200 MIN		0.008 MIN	
b	0.180	0.300	0.007	0.012
e	0.500 TYP		0.020 TYP	
L	0.250	0.450	0.010	0.018

TAPE AND REEL INFORMATION

REEL DIMENSIONS



TAPE DIMENSIONS



NOTE: The picture is only for reference. Please make the object as the standard.

KEY PARAMETER LIST OF TAPE AND REEL

Package Type	Reel Diameter	Reel Width W1 (mm)	A0 (mm)	B0 (mm)	K0 (mm)	P0 (mm)	P1 (mm)	P2 (mm)	W (mm)	Pin1 Quadrant
TDFN-3×3-8L	13"	12.4	3.35	3.35	1.13	4.0	8.0	2.0	12.0	Q1
TDFN-2×2-8L	7"	9.5	2.30	2.30	1.10	4.0	4.0	2.0	8.0	Q1

DD0001

PACKAGE INFORMATION

CARTON BOX DIMENSIONS



NOTE: The picture is only for reference. Please make the object as the standard.

KEY PARAMETER LIST OF CARTON BOX

Reel Type	Length (mm)	Width (mm)	Height (mm)	Pizza/Carton
7" (Option)	368	227	224	8
7"	442	410	224	18
13"	386	280	370	5

DD0002