

GENERAL DESCRIPTION

The SGM4027 is a precision, low power, low noise and low dropout voltage reference, which is designed to offer low temperature drift and high initial accuracy while consuming only 245µA (TYP) quiescent current.

The SGM4027 features high precision and low power consumption. The combination of these characteristics makes the device ideal for use in industrial applications, such as transmitters of temperature and pressure. To keep the stability and decrease the output noise of the output voltage, a capacitor with the capacitance of 2µF to 22µF should be added at the output pin of SGM4027.

For the typical operation, the power supply voltage should be 0.2V beyond the V_{REF} . Due to the advantage of low dropout and low power dissipation, it is recommended to use SGM4027 in portable and battery-powered equipment.

The SGM4027 is available in a Green SOT-23 package. It is specified over the extended industrial temperature range of -40°C to +125°C.

FEATURES

- **Low Dropout Voltage: 0.2V (MAX)**
- **High Output Current: 10mA (MAX)**
- **Limited Output Current: 25mA**
- **Stable Output C_{LOAD} Range: 2µF to 22µF**
- **High Initial Accuracy: 0.1% (MAX)**
- **Low Temperature Drift:**
 35ppm/°C (MAX) from -40°C to +125°C
- **Low Quiescent Current: 245µA (TYP)**
- **-40°C to +125°C Operating Temperature Range**
- **Available in a Green SOT-23 Package**

APPLICATIONS

- Temperature and Pressure Transmitters
- Handheld Test Equipment
- Precision Data-Acquisition Systems
- Portable Devices
- Battery-Powered Equipment
- Medical Instrumentation

TYPICAL APPLICATION

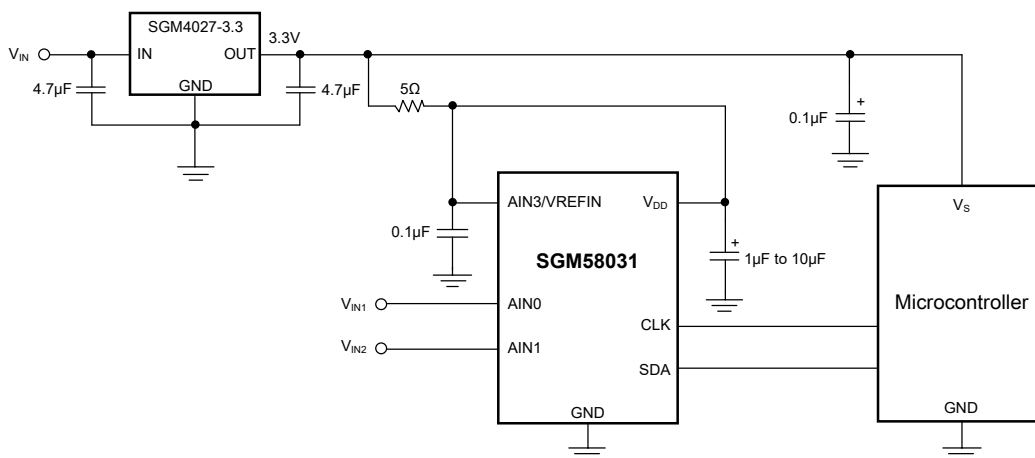
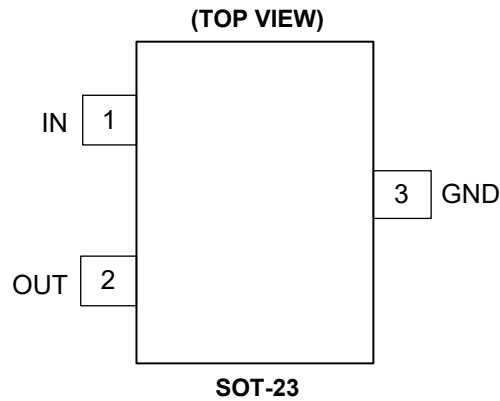

Figure 1. Typical Application Circuit

PIN CONFIGURATION



PIN DESCRIPTION

PIN	NAME	I/O	FUNCTION
1	IN	I	Power Supply.
2	OUT	O	Reference Voltage Output.
3	GND	—	Ground.

ELECTRICAL CHARACTERISTICS

(At $T_A = +25^\circ\text{C}$, $V_{IN} = 5\text{V}$, $I_{LOAD} = 0\text{mA}$, unless otherwise noted.)

PARAMETER	SYMBOL	CONDITIONS	MIN	TYP	MAX	UNITS
SGM4027-2.048						
Output Voltage	V_{OUT}			2.048		V
Initial Accuracy			-0.1		+0.1	%
Solder Heat Resistance Shift				±0.03		%
Output Voltage Noise		f = 0.1Hz to 10Hz		8.9		μV _{PP/V}
		f = 10Hz to 10kHz		24.3		μV _{RMS}
Output Voltage Noise Density		f = 1kHz		223		nV/√Hz
Line Regulation		$3.0\text{V} \leq V_{IN} \leq 5.5\text{V}$		4.5		ppm/V
SGM4027-2.5						
Output Voltage	V_{OUT}			2.5		V
Initial Accuracy			-0.1		+0.1	%
Solder Heat Resistance Shift				±0.03		%
Output Voltage Noise		f = 0.1Hz to 10Hz		8.9		μV _{PP/V}
		f = 10Hz to 10kHz		29.8		μV _{RMS}
Output Voltage Noise Density		f = 1kHz		273		nV/√Hz
Line Regulation		$V_{REF} + 0.5\text{V} \leq V_{IN} \leq 5.5\text{V}$		4.0		ppm/V
SGM4027-3.0						
Output Voltage	V_{OUT}			3.0		V
Initial Accuracy			-0.1		+0.1	%
Solder Heat Resistance Shift				±0.03		%
Output Voltage Noise		f = 0.1Hz to 10Hz		8.9		μV _{PP/V}
		f = 10Hz to 10kHz		35.5		μV _{RMS}
Output Voltage Noise Density		f = 1kHz		327		nV/√Hz
Line Regulation ⁽¹⁾		$V_{REF} + 0.5\text{V} \leq V_{IN} \leq 5.5\text{V}$		7.0		ppm/V
SGM4027-3.3						
Output Voltage	V_{OUT}			3.3		V
Initial Accuracy			-0.1		+0.1	%
Solder Heat Resistance Shift				±0.03		%
Output Voltage Noise		f = 0.1Hz to 10Hz		8.9		μV _{PP/V}
		f = 10Hz to 10kHz		39.1		μV _{RMS}
Output Voltage Noise Density		f = 1kHz		360		nV/√Hz
Line Regulation ⁽¹⁾		$V_{REF} + 0.5\text{V} \leq V_{IN} \leq 5.5\text{V}$		7.0		ppm/V
SGM4027-4.096						
Output Voltage	V_{OUT}			4.096		V
Initial Accuracy			-0.1		+0.1	%
Solder Heat Resistance Shift				±0.03		%
Output Voltage Noise		f = 0.1Hz to 10Hz		8.9		μV _{PP/V}
		f = 10Hz to 10kHz		48.5		μV _{RMS}
Output Voltage Noise Density		f = 1kHz		447		nV/√Hz
Line Regulation ⁽¹⁾		$V_{REF} + 0.5\text{V} \leq V_{IN} \leq 5.5\text{V}$		15.0		ppm/V

NOTE:

- For $V_{REF} > 2.5\text{V}$ version, SGM4027 can work at $V_{REF} + 0.3\text{V}$ supply voltage. On this supply condition, line regulation and PSRR may drop to about 20 ~ 30dB.
For $V_{REF} > 2.5\text{V}$ version, SGM4027 can also work at $V_{REF} + 0.2\text{V}$ supply voltage. On this supply condition, line regulation and PSRR may drop to about 30 ~ 40dB.

ELECTRICAL CHARACTERISTICS (continued)(At $T_A = +25^\circ\text{C}$, $V_{IN} = 5\text{V}$, $I_{LOAD} = 0\text{mA}$, unless otherwise noted.)

PARAMETER	SYMBOL	CONDITIONS	MIN	TYP	MAX	UNITS
SGM4027						
Output Voltage Temperature Drift ⁽²⁾	dV_{OUT}/dT	$-40^\circ\text{C} \leq T_A \leq +125^\circ\text{C}$		10	35	ppm/°C
Long-Term Stability		0h to 1000h, $I_{OUT} = 0\text{mA}$		120		ppm
		1000h to 2000h, $I_{OUT} = 0\text{mA}$		20		
Load Regulation ⁽³⁾	$\Delta V_{O(\Delta I_L)}$	$-10\text{mA} < I_{LOAD} < 10\text{mA}$ ⁽⁴⁾		5	15	ppm/mA
Thermal Hysteresis	dT			150		ppm
Dropout Voltage	$V_{IN} - V_{OUT}$			5	200	mV
Short-Circuit Current	I_{SC}			25		mA
Turn-On Settling Time		To 0.1% with $C_{LOAD} = 2.2\mu\text{F}$		800		µs
Power Supply						
Quiescent Current	I_Q			245	320	µA
		$-40^\circ\text{C} \leq T_A \leq +125^\circ\text{C}$			340	
Power Supply Range	V_{CC}		3		5.5	V

NOTES:

- The way to determine temperature drift is using Box Method.
- Load regulation is Kelvin sensed at the package.
- The minimum supply voltage for SGM4027-2.048 and SGM4027-2.5 is 3.0V.

TYPICAL PERFORMANCE CHARACTERISTICS

At $T_A = +25^\circ\text{C}$, $V_{OUT} = 2.5\text{V}$, unless otherwise noted.

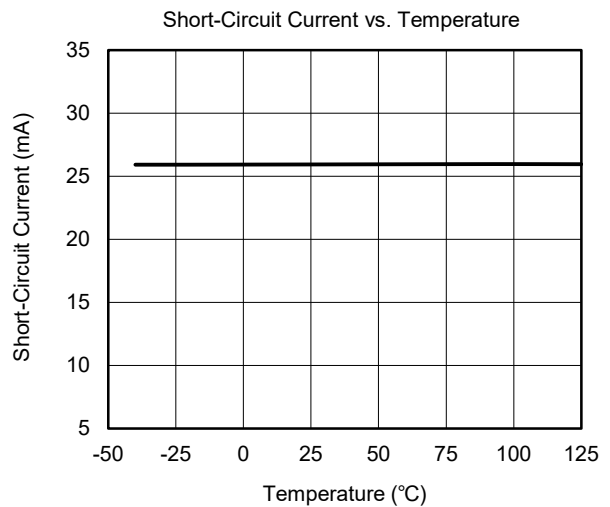
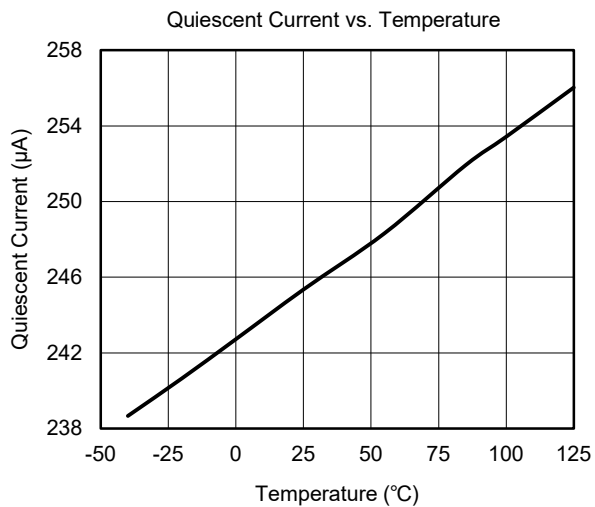
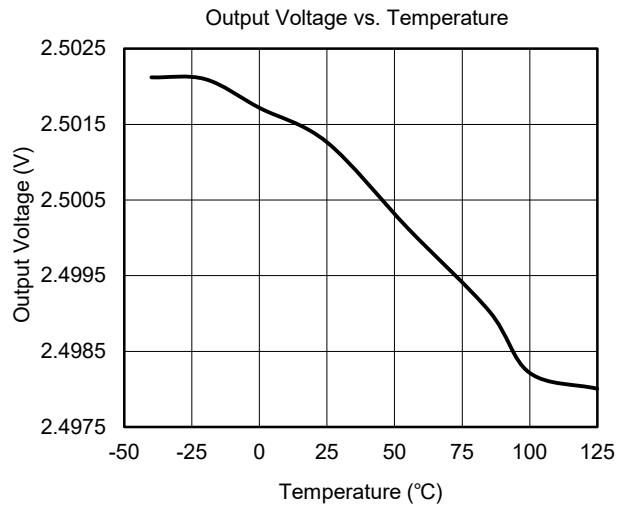
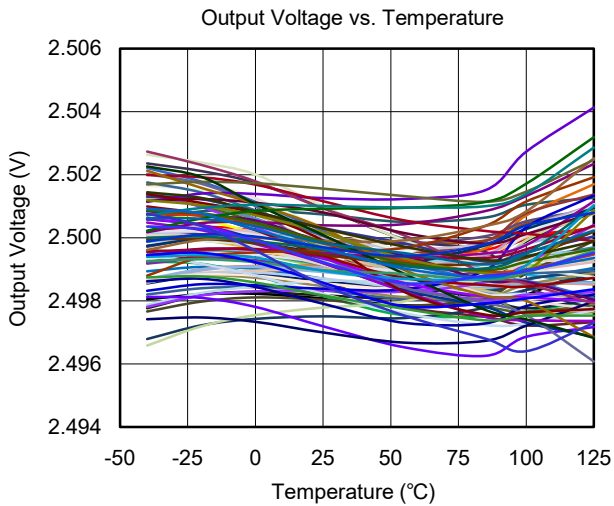
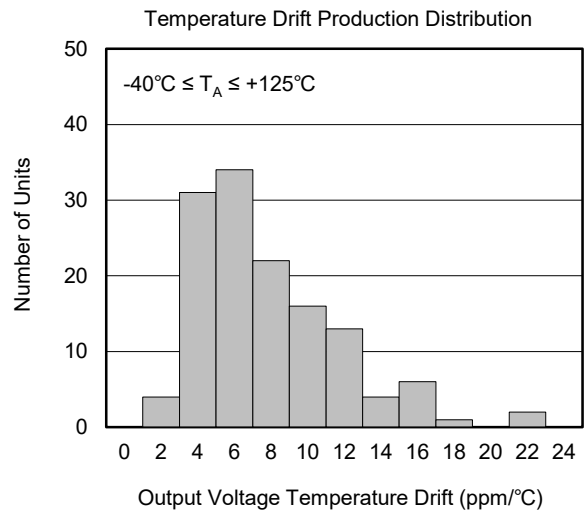
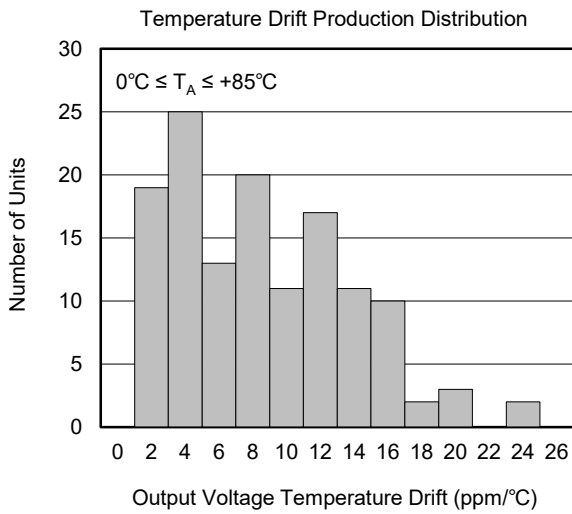

TYPICAL PERFORMANCE CHARACTERISTICS (continued)

At $T_A = +25^\circ\text{C}$, $V_{OUT} = 2.5\text{V}$, unless otherwise noted.

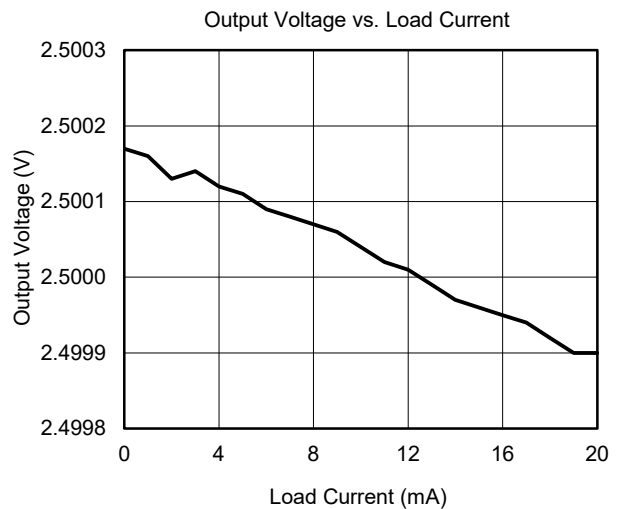
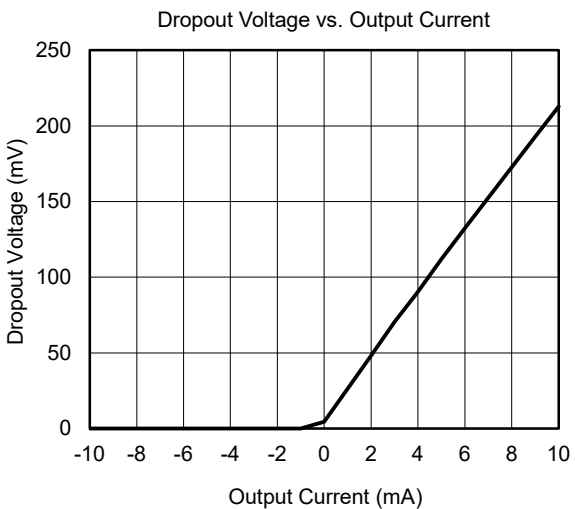
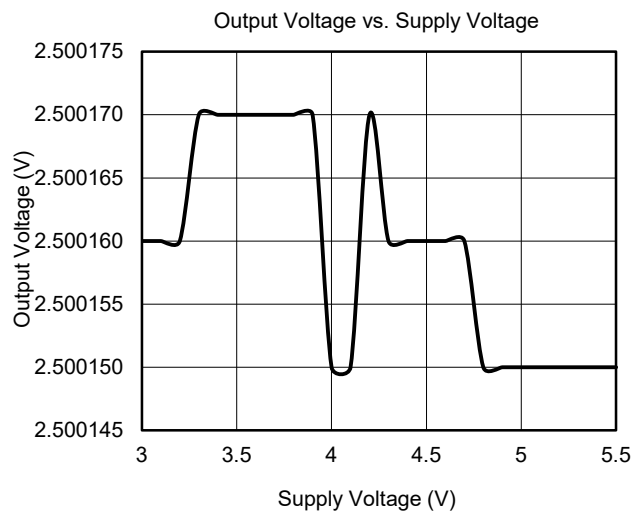
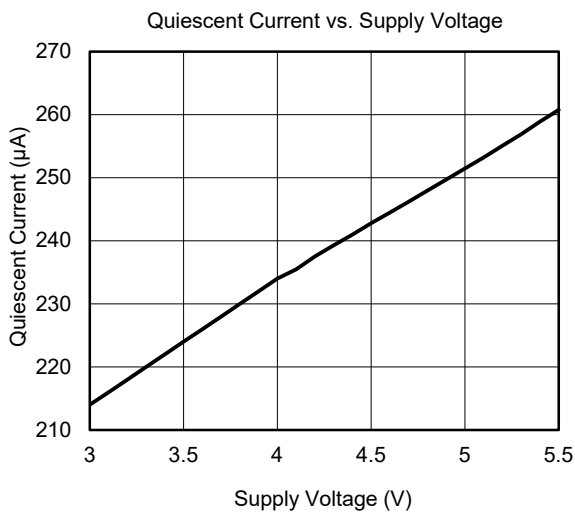
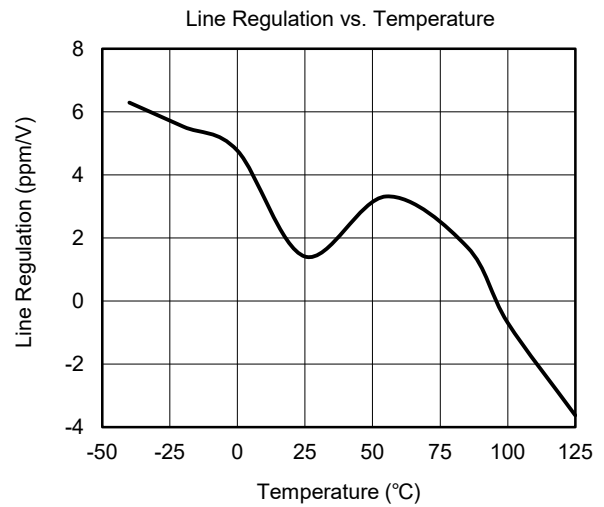
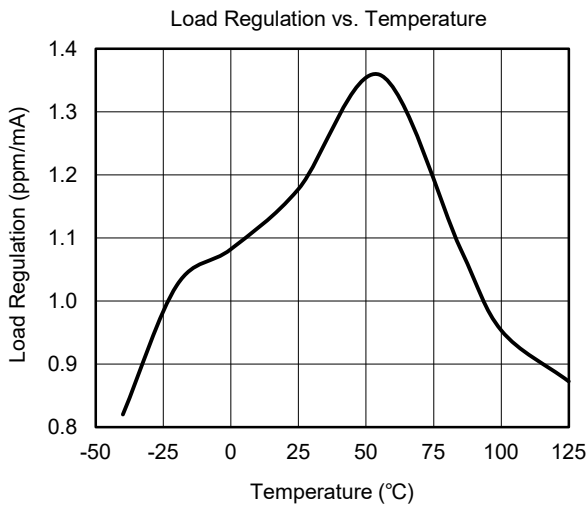

TYPICAL PERFORMANCE CHARACTERISTICS (continued)

At $T_A = +25^\circ\text{C}$, $V_{OUT} = 2.5\text{V}$, unless otherwise noted.

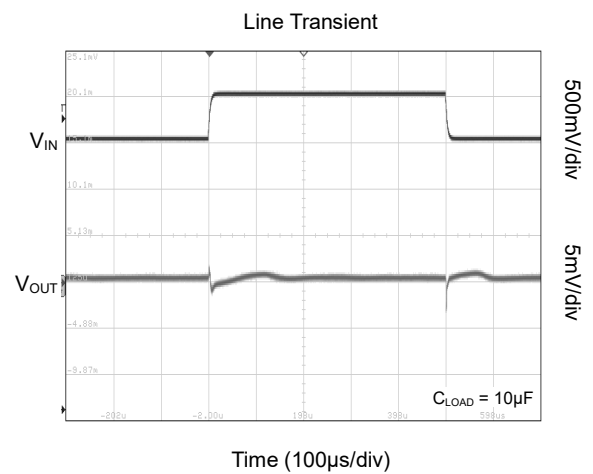
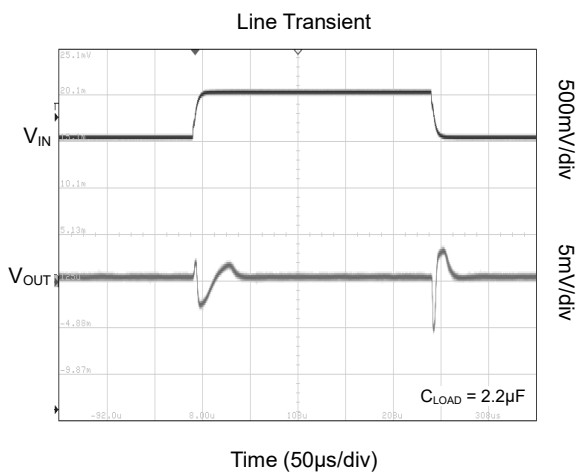
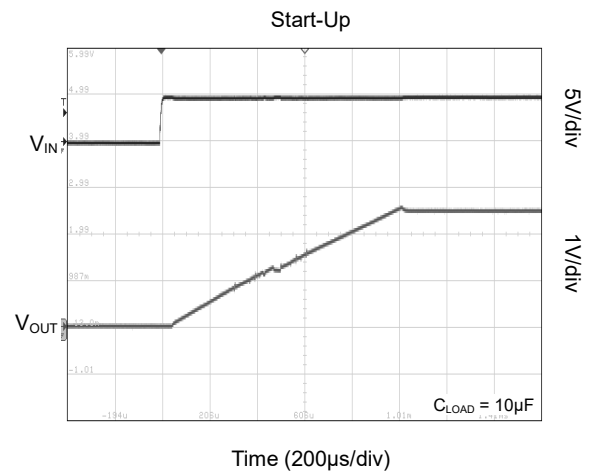
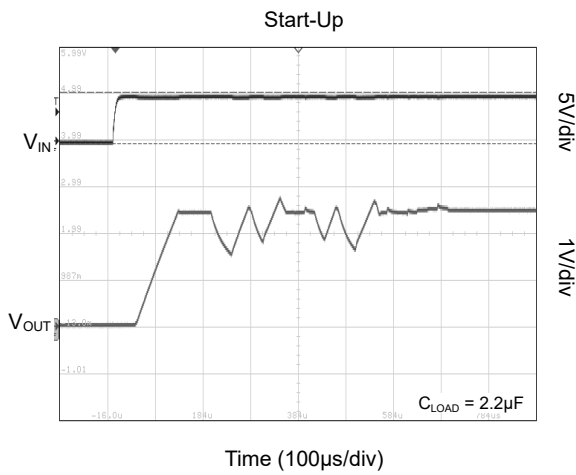
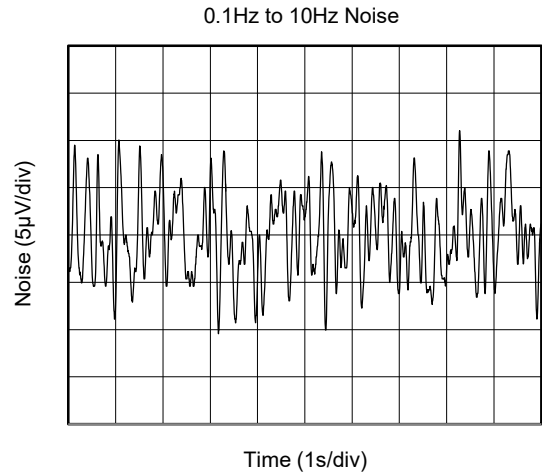
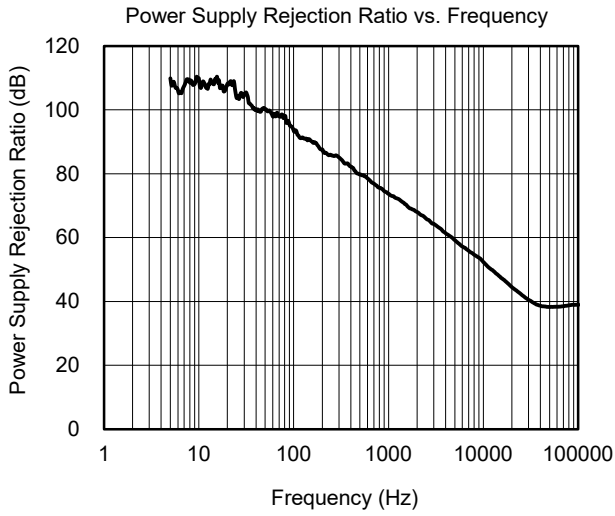

TYPICAL PERFORMANCE CHARACTERISTICS (continued)

At $T_A = +25^\circ\text{C}$, $V_{\text{OUT}} = 2.5\text{V}$, unless otherwise noted.

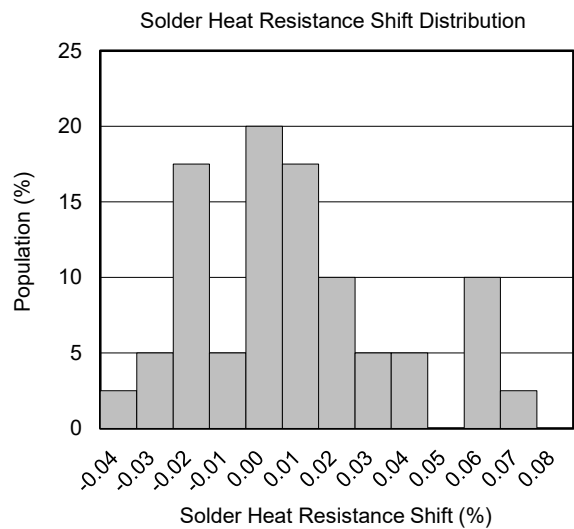
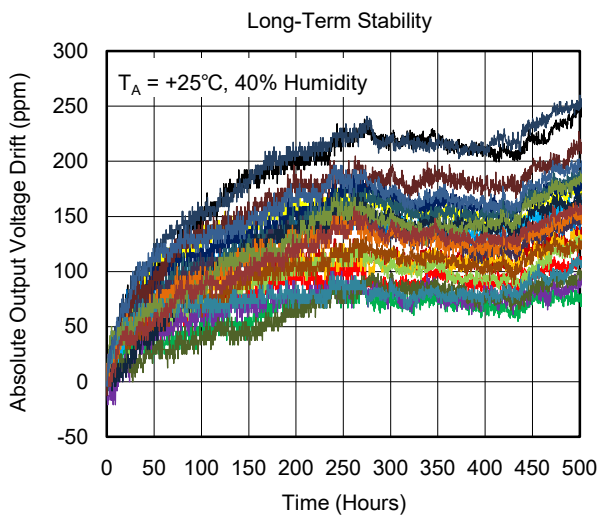
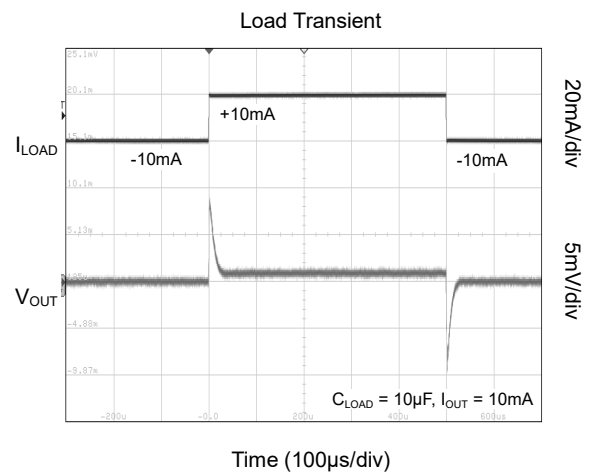
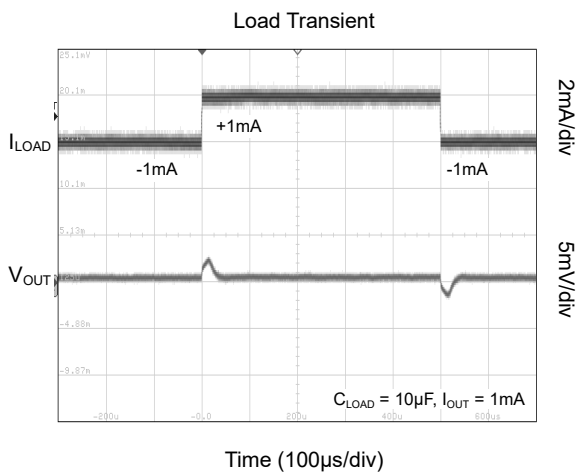
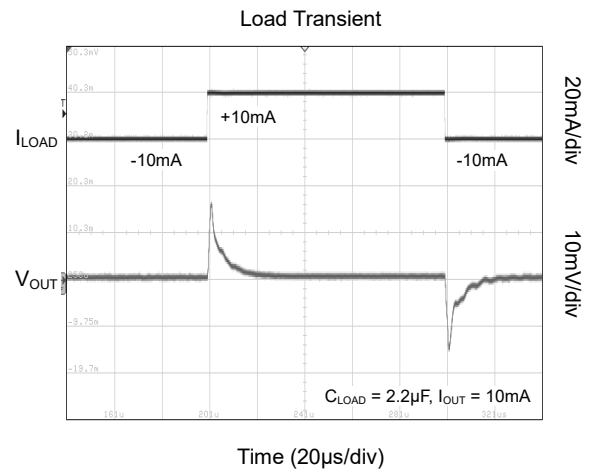
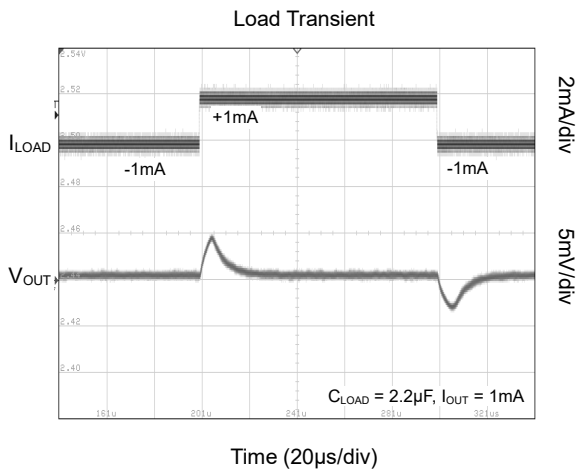

FUNCTIONAL BLOCK DIAGRAM

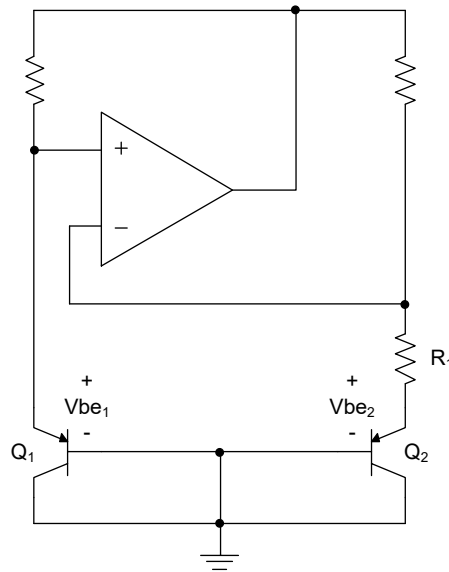

Figure 2. Block Diagram

DETAILED DESCRIPTION (continued)

Overview

The SGM4027 is a precision voltage reference with CMOS and bandgap technology and the above block diagram indicates its internal structure. The current density of Q_1 is greater than Q_2 and both two transistors are biased. The voltage across R_1 is the voltage difference of V_{be_1} and V_{be_2} . Also, the amplifier will amplify this voltage difference ($V_{be_1} - V_{be_2}$) and feed it back to the emitter of Q_2 , which has a negative temperature coefficient. With doing so, the output voltage cannot be affected by the external temperature. However, there is curvature for the bandgap voltage of the voltage reference, the reason for that is the temperature coefficient of V_{be_2} of Q_2 is non-linear.

Feature Description

Supply Voltage

The maximum dropout voltage for SGM4027 series is 0.2V and it can be operated with a power supply between ($V_{REF} + 0.2V$) to 5.5V.

Due to the advantage of ultra-low quiescent current of SGM4027, the stability of the output voltage is significant enhanced. As illustrated in the Electrical Characteristics, the quiescent current which is measured at +25°C is 245μA, and the maximum one over the temperature range is 340μA. Moreover, over the whole operation range of power supply voltage, the change of quiescent current is less than 50μA.

Thermal Hysteresis

To measure the thermal hysteresis, the V_{OUT} of the device should be measured at the temperature of +25°C. After finishing this, the SGM4027 will be cycled to the other temperatures, and then remove it back to +25°C and measure the V_{OUT} again. In conclusion, this voltage difference is the hysteresis of temperature.

$$V_{HYST} = \left(\frac{\text{abs}|V_{PRE} - V_{POST}|}{V_{NOM}} \right) \times 10^6 (\text{ppm}) \quad (1)$$

where:

V_{HYST} is the thermal hysteresis.

V_{PRE} is the output voltage measured at +25°C before the device is removed to the temperature range of -40°C to +125°C.

V_{POST} is the output voltage measured at +25°C after the device is removed to the temperature range of -40°C to +125°C.

Temperature Drift

Usually, the temperature change slightly affects the output of SGM4027. To evaluate this temperature drift, the Box Method is being used. After calculation, it is discovered that the temperature drift over the temperature range of -40°C to +125°C is 10ppm/°C (TYP).

Noise Performance

For the frequency within 0.1Hz to 10Hz, it is guaranteed that the noise level is below $8.9\mu V_{PP}/V$. The external temperature and V_{OUT} can increase the noise level. The technology of filtering can be taken into account to decrease the level of noise; however, this may increase the output impedance of SGM4027 and degrade the performance of AC output signal.

Long-Term Stability

Usually, SGM4027 measures the output voltage drift for several months or years to check if the V_{OUT} will change for long-term period. The curve of the long-term stability illustrates how the output voltage changes. Typically, from 0 to 1000 hours, the drift value is 120ppm; from 1000 hours to 2000 hours, the drift value is 20ppm. To evaluate this parameter, 23 units of SGM4027 are evaluated to guarantee the long-term stability.

Load Regulation

Different load current can result in load regulation. To measure the load regulation, the technology of sense and force contacts should be used, which is shown in Figure 3. To enhance the accuracy and reduce the effect of the trace and contact resistance, the lines should be tied to the output pin of SGM4027 directly. In conclusion, the force and sense line can decrease the impact of load regulation.

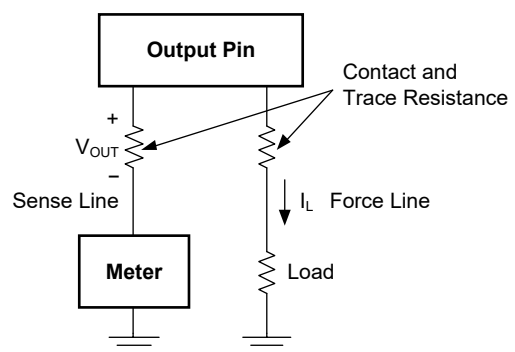

Figure 3. Accurate Load Regulation of SGM4027

DETAILED DESCRIPTION (continued)**Device Functional Modes****Negative Reference Voltage**

If users desire to use SGM4027 to guarantee positive and negative voltage, SGM4027 and SGM8263 should be taken into account. In Figure 4, the output of SGM8263 is equal to the negative value of SGM4027. The following circuit can also guarantee the accuracy as the offset voltage and drift of SGM8263 is also extreme low. In addition, the temperature coefficient of two resistors should be taken into account.

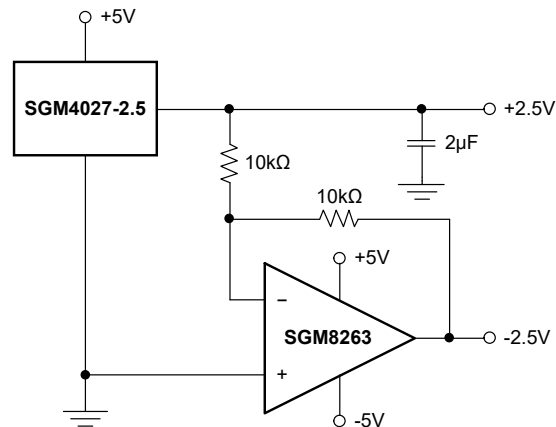

Figure 4. Positive and Negative Voltage Reference

APPLICATION INFORMATION

The advantage of accuracy and stability is beneficial for SGM4027 to be used as a voltage reference for analog-to-digital converters (ADC). Figure 5 shows a data acquisition system with SGM4027.

24-Bit, 32KSPS Data Acquisition System

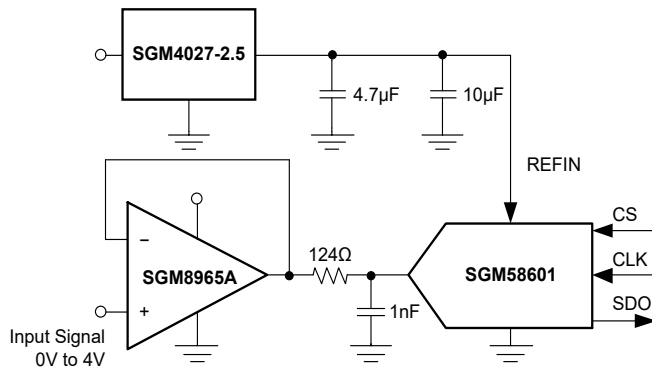

Figure 5. Data Acquisition System with SGM4027

Design Requirements

The output capacitor should guarantee a desired filtering performance for SGM4027. For enhance the stability, a bypass capacitor must be added at the input pin of SGM4027. In addition, a buffer and an RC filter should also be added at the input pin of the analog-to-digital converter to provide high driven performance and filter the noise from the input signal.

Detailed Design Procedure

The bandwidth of RC filter which is at the output of the buffer should be at least 4 times less than the bandwidth of SGM8965A and it can filter out the switch noise, which is provided by ADC when sampling, so the output voltage at 1nF capacitor will be settled to 24-bit accuracy within the corresponding acquisition time. In addition, to provide a voltage reference for SGM58601, SGM4027-2.5 should be taken into account so that the full-scale input voltage for SGM58601 is 5V ($V_{FS} = 2V_{REF}$).

Basic Connection

For typical connection which is shown in Figure 6, it is recommended that a capacitor from 2μF to 22μF should be connected at the OUT pin. For the condition of capacitive load, please take care when using low ESR capacitor or high capacitance. A 0.47μF capacitor should be connected to the IN pin for stability.

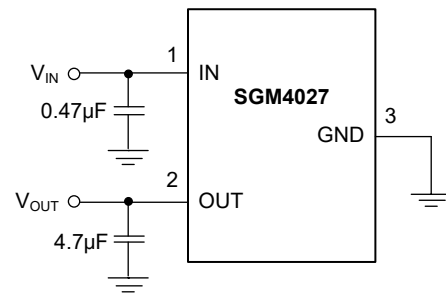

Figure 6. Typical Connections for Operating SGM4027

Layout Guidelines

Some key considerations of printed-circuit board (PCB) layout using the SGM4027 are:

- ◆ A low ESR bypass capacitor with 0.47μF should be added at the input of SGM4027.
- ◆ A decouple capacitor should be also added for the device which is associated with SGM4027.
- ◆ A solid ground plane should be taken into account to decrease EMI and distribute heat.
- ◆ The external passive devices should be added as close as possible to SGM4027 in order to reduce the error which is from the parasitic parameter.
- ◆ The length of trace in PCB for the connections of ADC and INA should be as short as possible to decrease any possible noise.
- ◆ The analog trace should not be parallel with the digital trace to prevent the crosstalk. If the PCB is complicated and the crossing of these two traces cannot be avoid, then please make them in the different layer and keep perpendicular.

REVISION HISTORY

NOTE: Page numbers for previous revisions may differ from page numbers in the current version.

MAY 2022 – REV.A to REV.A.1	Page
Updated Electrical Characteristics section	5
Updated 24-Bit, 32KSPS Data Acquisition System section	13

Changes from Original (MARCH 2022) to REV.A	Page
Changed from product preview to production data	All

PACKAGE OUTLINE DIMENSIONS

SOT-23

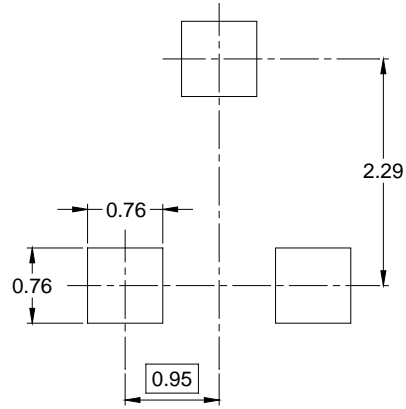
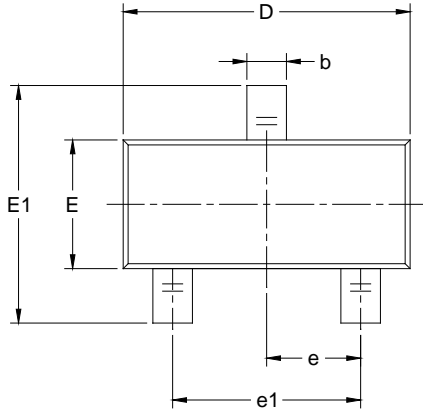

RECOMMENDED LAND PATTERN (Unit: mm)

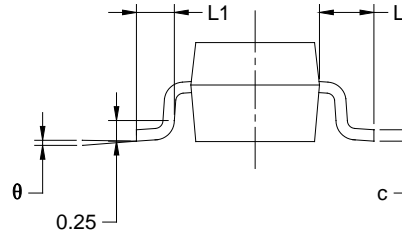
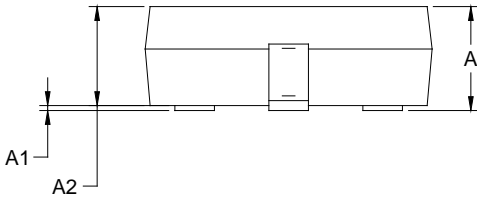

Symbol	Dimensions In Millimeters		Dimensions In Inches	
	MIN	MAX	MIN	MAX
A	0.89	1.12	0.035	0.044
A1	0.01	0.10	0.000	0.004
A2	0.88	1.02	0.035	0.040
b	0.30	0.50	0.012	0.020
c	0.08	0.20	0.003	0.008
D	2.80	3.04	0.110	0.120
E	1.20	1.40	0.047	0.055
E1	2.10	2.64	0.083	0.104
e	0.95 BSC		0.037 BSC	
e1	1.90 BSC		0.075 BSC	
L	0.54 REF		0.021 REF	
L1	0.40	0.60	0.016	0.024
θ	0°	8°	0°	8°

NOTES:

1. Body dimensions do not include mode flash or protrusion.
2. This drawing is subject to change without notice.

PACKAGE INFORMATION

TAPE AND REEL INFORMATION

REEL DIMENSIONS



TAPE DIMENSIONS



NOTE: The picture is only for reference. Please make the object as the standard.

KEY PARAMETER LIST OF TAPE AND REEL

Package Type	Reel Diameter	Reel Width W1 (mm)	A0 (mm)	B0 (mm)	K0 (mm)	P0 (mm)	P1 (mm)	P2 (mm)	W (mm)	Pin1 Quadrant
SOT-23	7"	9.5	3.15	2.77	1.22	4.0	4.0	2.0	8.0	Q3

000001

PACKAGE INFORMATION

CARTON BOX DIMENSIONS



NOTE: The picture is only for reference. Please make the object as the standard.

KEY PARAMETER LIST OF CARTON BOX

Reel Type	Length (mm)	Width (mm)	Height (mm)	Pizza/Carton
7" (Option)	368	227	224	8
7"	442	410	224	18

DD0002