

修订 REV	标记 MARK	修改摘要 REVISION DESCRIPTION	签名 SIGNATURE	日期 DATE
AO		NEW RELEASE	黄艳兰	2019-05-09

主要技术参数 Main Specifications

线数 (Poles): 02 to 20
 接触电阻 (Contact resistance): $\leq 20m\Omega$
 绝缘电阻 (Insulation resistance): $\geq 100M\Omega$
 额定电压 (Rated voltage): 125V AC DC
 额定电流 (Rated current): 1.0A AC DC
 耐电压 (Withstand Voltage): 500V AC/minute
 温度范围 (Temperature Range): $-25^{\circ}C \sim +85^{\circ}C$

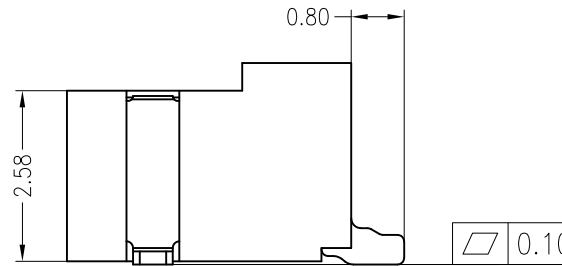
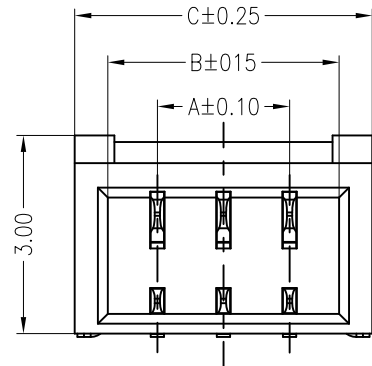
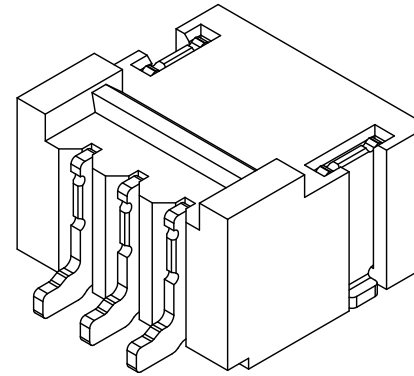
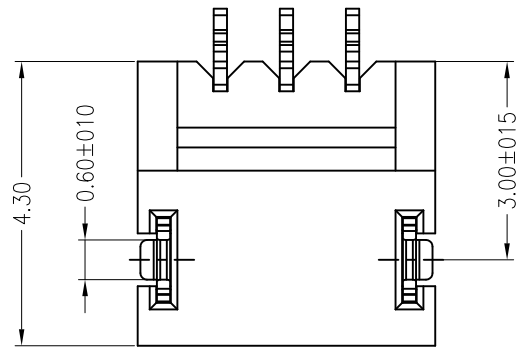

材质: 壳体: PA6T(BEIGE), PIN针: 磷铜/镀锡

孔位	尺寸	A	B	C	孔位	尺寸	A	B	C
2P	1.00	2.50	3.50	12P	11.00	12.5	13.5		
3P	2.00	3.50	4.50	13P	12.00	13.5	14.5		
4P	3.00	4.50	5.50	14P	13.00	14.5	15.5		
5P	4.00	5.50	6.50	15P	14.00	15.5	16.5		
6P	5.00	6.50	7.50	16P	15.00	16.5	17.5		
7P	6.00	7.50	8.50	17P	16.00	17.5	18.5		
8P	7.00	8.50	9.50	18P	17.00	18.5	19.5		
9P	8.00	9.50	10.5	19P	18.00	19.5	20.5		
10P	9.00	10.50	11.5	20P	19.00	20.5	21.5		
11P	10.00	11.50	12.5						

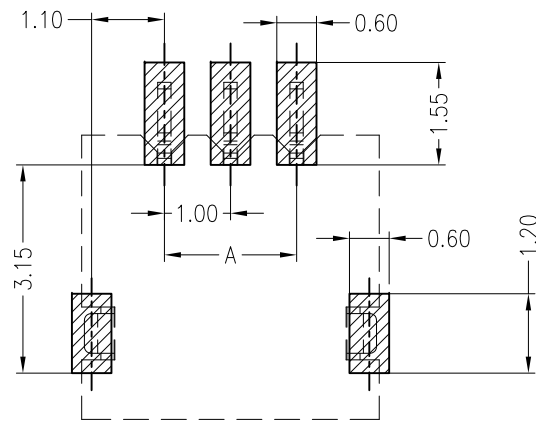

PCB LAYOUT(Tolerance:±0.05)



深圳市华德共创科技有限公司

Shenzhen Huade co-create Technology Co.,LTD

TEL: 0755-27111225 FAX: 0755-29940187

-TOLERANCES- UNLESS OTHERWISE SPECIFIED 公差参数表				TITLE: 产品名称: NH1.0带扣卧贴				
X.X	±0.30	X.X°	±3°	APPD: 核准: 谢亮	PART NO: 产品编号: HDGC1002WRF-S-XP-2			
X.XX	±0.30	X.XX°	±2°	CHECK: 校对: 王建业	DATE	SCALE	UNIT	CODE NUMBER
X.XXX	±0.10	X.XXX°	±1°	DRAW: 绘图: 黄艳兰	2019-05-09	1:1	mm	A018