

Product Summary

- $V_{DS} = -20V, I_D = -6A$
 $R_{DS(ON)} < 28m\Omega(max) @ V_{GS} = -2.5V$
 $R_{DS(ON)} < 20m\Omega(max) @ V_{GS} = -4.5V$

Application

- Load/Power Switching
- Interfacing Switching
- Logic Level Shift

Package and Pin Configuration

SOT-23



Circuit diagram

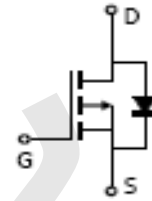

Absolute Maximum Ratings (TA=25°C unless otherwise noted)

Parameter	Symbol	Limit	Unit
Drain-Source Voltage	V_{DS}	-20	V
Gate-Source Voltage	V_{GS}	±12	V
Drain Current -Continuous	I_D	-6	A
Drain Current -Pulsed ^(Note 1)	I_{DM}	-24	A
Maximum Power Dissipation	P_D	1.8	W
Operating Junction and Storage Temperature Range	T_J, T_{STG}	-55 To 150	°C

Thermal Characteristic

Thermal Resistance, Junction-to-Ambient ^(Note 2)	$R_{\theta JA}$	69	°C/W
---	-----------------	----	------

Electrical Characteristics (TA=25°C unless otherwise noted)

Parameter	Symbol	Condition	Min	Typ	Max	Unit
Off Characteristics						
Drain-Source Breakdown Voltage	BV_{DSS}	$V_{GS}=0V, I_D=-250\mu A$	-20	-	-	V
Zero Gate Voltage Drain Current	I_{DSS}	$V_{DS}=-12V, V_{GS}=0V$	-	-	-1	μA
Gate-Body Leakage Current	I_{GSS}	$V_{GS}=\pm 12V, V_{DS}=0V$	-	-	± 100	nA
On Characteristics (Note 3)						
Gate Threshold Voltage	$V_{GS(th)}$	$V_{DS}=V_{GS}, I_D=-250\mu A$	-0.4	-0.55	-1.0	V
Drain-Source On-State Resistance	$R_{DS(ON)}$	$V_{GS}=-4.5V, I_D=-6A$	-	18	20	m Ω
		$V_{GS}=-2.5V, I_D=-5A$	-	22	28	
Forward Transconductance	g_{FS}	$V_{DS}=-5V, I_D=-6A$	-	20	-	S
Dynamic Characteristics (Note4)						
Input Capacitance	C_{iss}	$V_{DS}=-6V, V_{GS}=0V,$ $F=1.0MHz$	-	1730	-	PF
Output Capacitance	C_{oss}		-	320	-	PF
Reverse Transfer Capacitance	C_{rss}		-	210	-	PF
Switching Characteristics (Note 4)						
Turn-on Delay Time	$t_{d(on)}$	$V_{DD}=-6V, I_D=-1A,$ $R_L=6\Omega, V_{GEN}=-4.5V, R_g=6\Omega$	-	20	-	nS
Turn-on Rise Time	t_r		-	35	-	nS
Turn-Off Delay Time	$t_{d(off)}$		-	90	-	nS
Turn-Off Fall Time	t_f		-	70	-	nS
Total Gate Charge	Q_g	$V_{DS}=-6V, I_D=-6A, V_{GS}=-4.5V$	-	19.5	-	nC
Gate-Source Charge	Q_{gs}		-	4.1	-	nC
Gate-Drain Charge	Q_{gd}		-	5.2	-	nC
Drain-Source Diode Characteristics						
Diode Forward Voltage (Note 3)	V_{SD}	$V_{GS}=0V, I_S=-1.0A$	-	-	-1.2	V
Diode Forward Current (Note 2)	I_S		-	-	-6	A



Typical Electrical and Thermal Characteristics

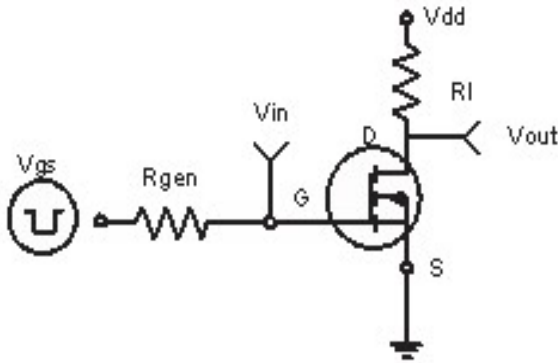

Figure 1: Switching Test Circuit

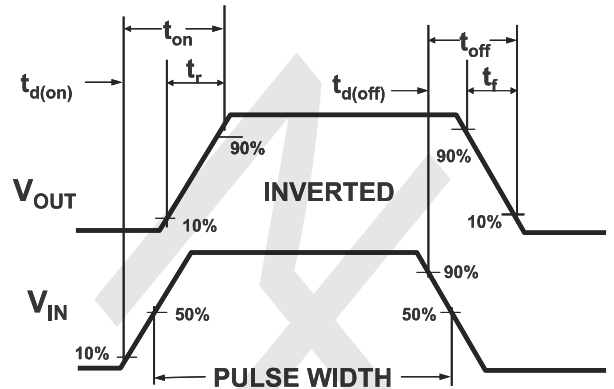

Figure 2: Switching Waveforms

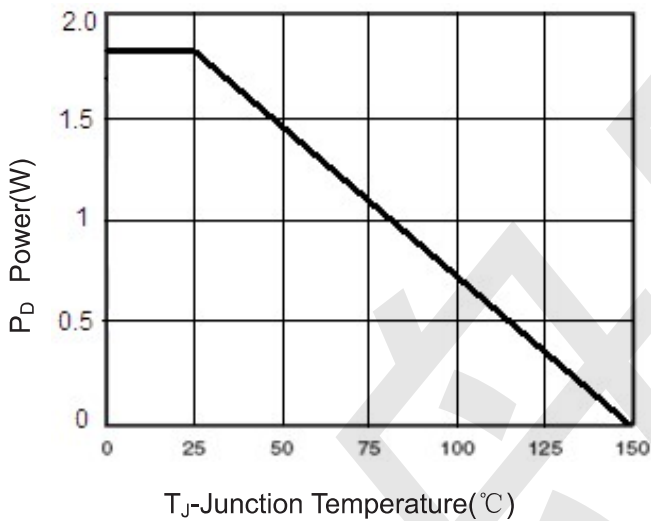

Figure 3 Power Dissipation

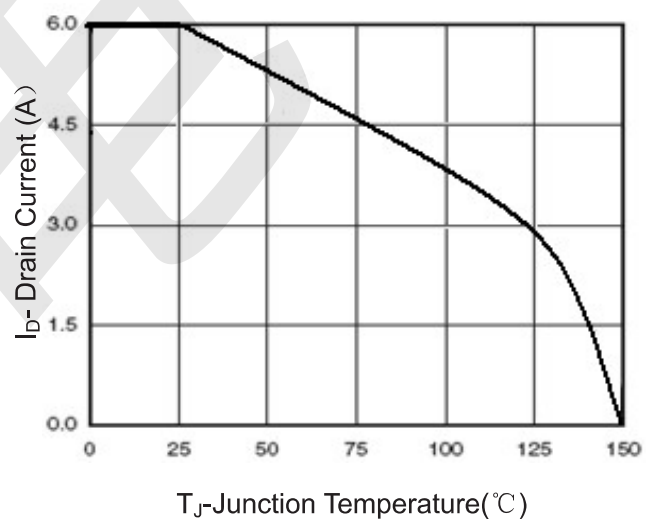

Figure 4 Drain Current

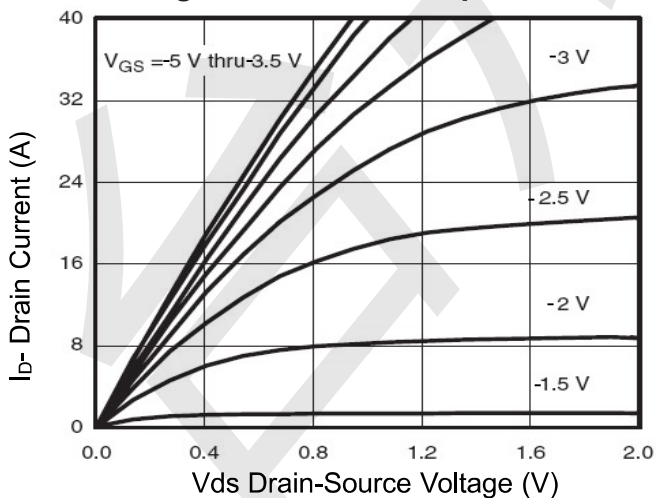

Figure 5 Output Characteristics

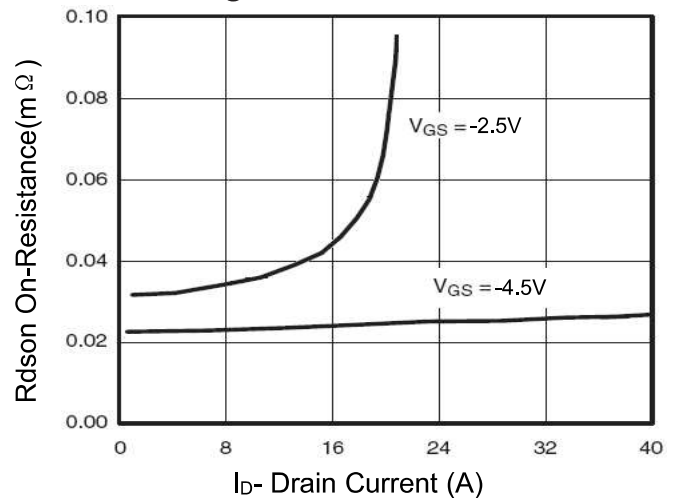

Figure 6 Drain-Source On-Resistance

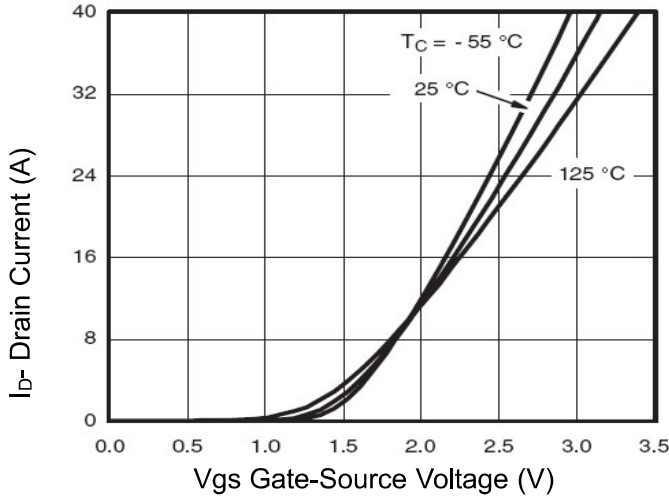

Figure 7 Transfer Characteristics

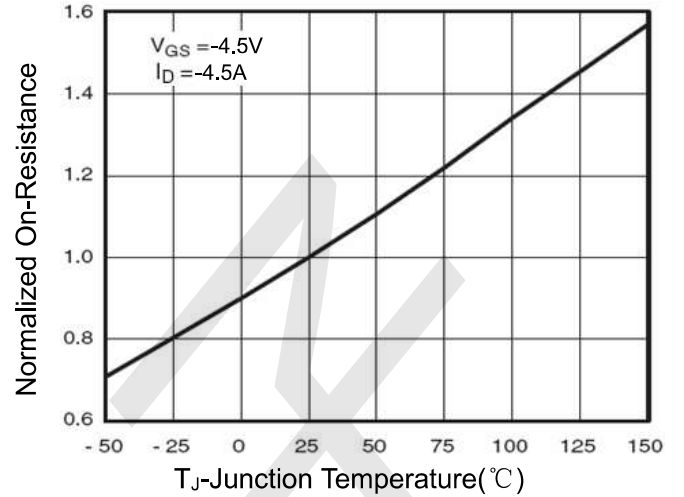

Figure 8 Drain-Source On-Resistance

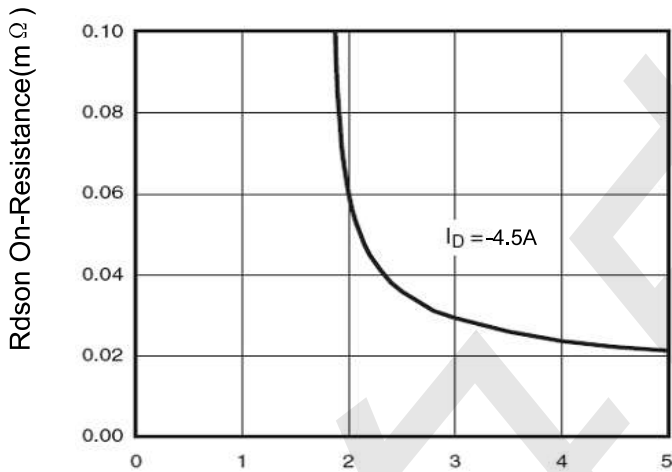

Figure 9 Rdson vs Vgs

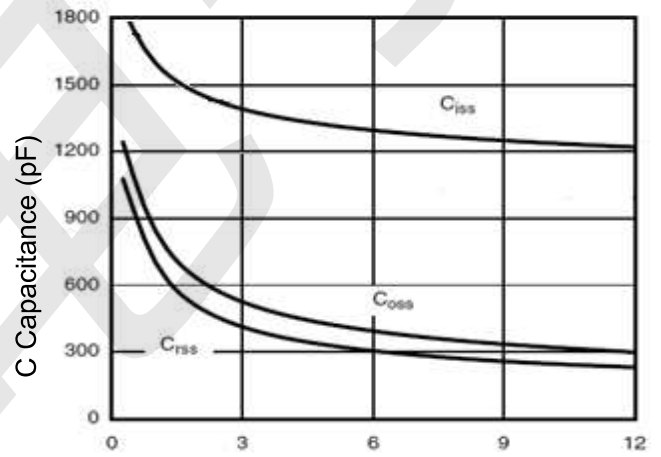

Figure 10 Capacitance vs Vds

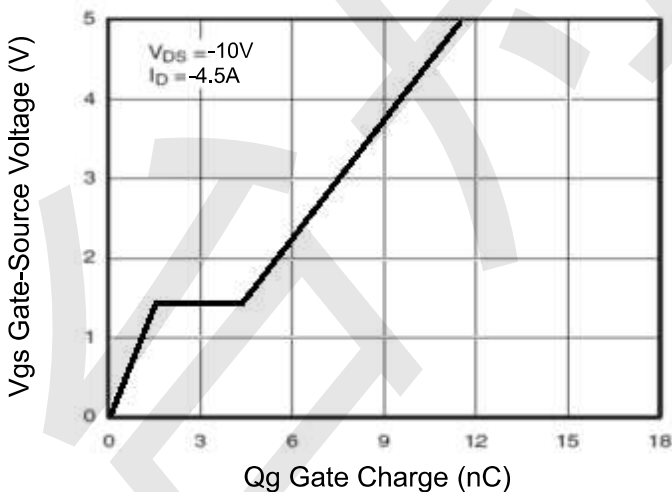

Figure 11 Gate Charge

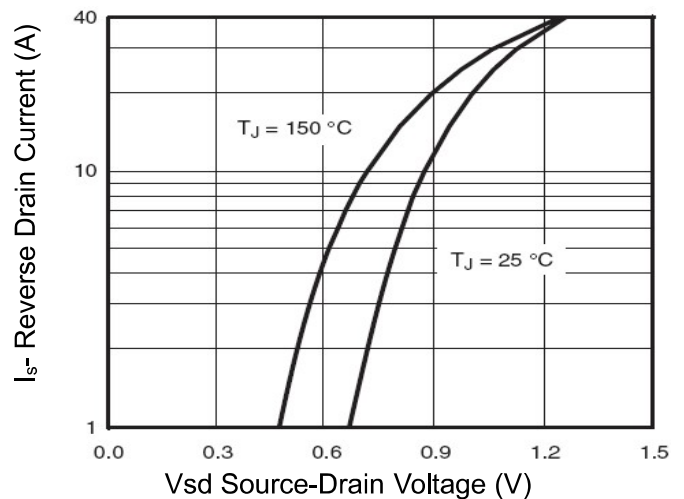

Figure 12 Source- Drain Diode Forward

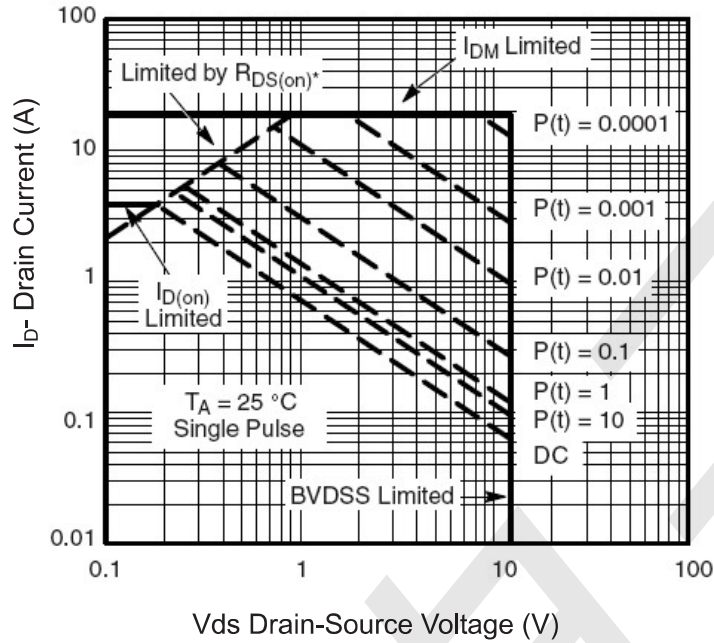

Figure 13 Safe Operation Area

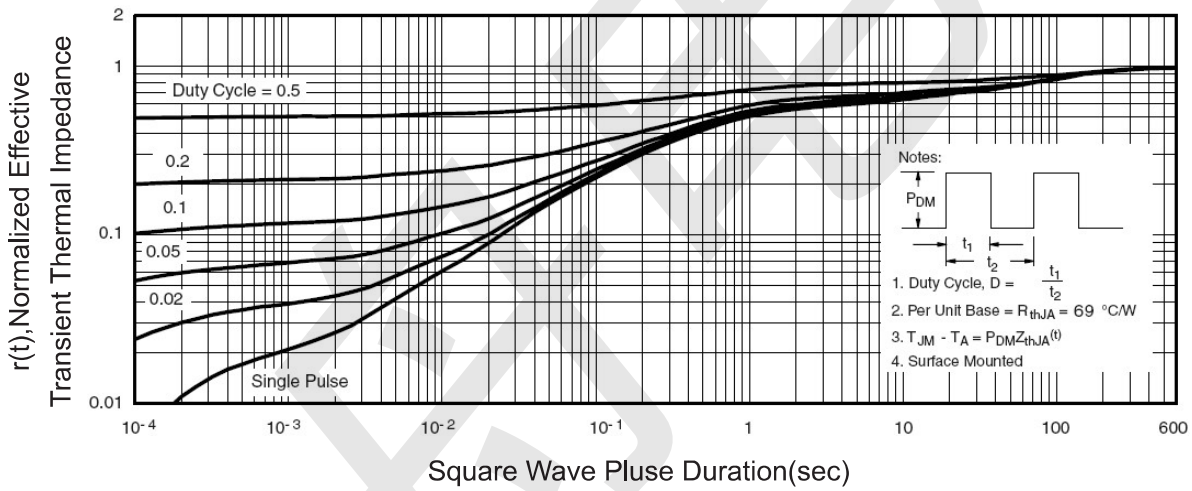
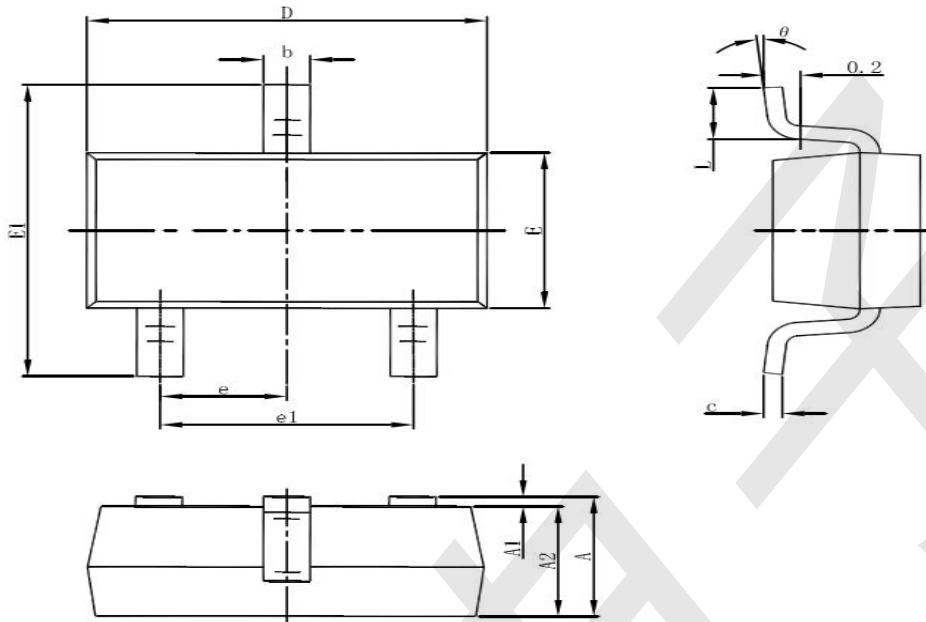

Figure 14 Normalized Maximum Transient Thermal Impedance



3-pin SOT23-3 Outline Dimensions



Symbol	Dimensions In Millimeters		Dimensions In Inches	
	Min	Max	Min	Max
A	1.050	1.250	0.041	0.049
A1	0.000	0.100	0.000	0.004
A2	1.050	1.150	0.041	0.045
b	0.300	0.500	0.012	0.020
c	0.100	0.200	0.004	0.008
D	2.820	3.020	0.111	0.119
E	1.500	1.700	0.059	0.067
E1	2.650	2.950	0.104	0.116
e	0.950(BSC)		0.037(BSC)	
e1	1.800	2.000	0.071	0.079
L	0.300	0.600	0.012	0.024
θ	0°	8°	0°	8°

Marking:



Or

