

# SS8050W TRANSISTOR(NPN)

## FEATURES

- Complimentary to SS8550W

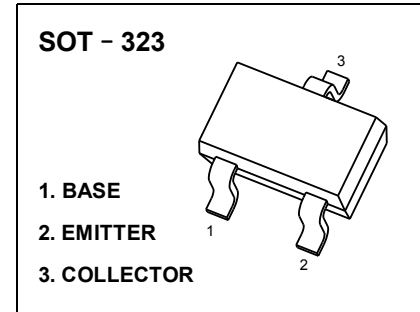

## MAXIMUM RATINGS ( $T_A=25^{\circ}\text{C}$ unless otherwise noted)

Symbol	Parameter	Value	Units
$V_{CB0}$	Collector-Base Voltage	40	V
$V_{CEO}$	Collector-Emitter Voltage	25	V
$V_{EBO}$	Emitter-Base Voltage	5	V
$I_C$	Collector Current -Continuous	1.5	A
$P_C$	Collector Power Dissipation	0.2	W
$T_j$	Junction Temperature	150	$^{\circ}\text{C}$
$T_{stg}$	Storage Temperature	-55-150	$^{\circ}\text{C}$

## ELECTRICAL CHARACTERISTICS ( $T_a=25^{\circ}\text{C}$ unless otherwise specified)

Parameter	Symbol	Test conditions	MIN	TYP	MAX	UNIT
Collector-base breakdown voltage	$V_{(BR)CB0}$	$I_C=100\mu\text{A}, I_E=0$	40			V
Collector-emitter breakdown voltage	$V_{(BR)CEO}$	$I_C=0.1\text{mA}, I_B=0$	25			V
Emitter-base breakdown voltage	$V_{(BR)EBO}$	$I_E=100\mu\text{A}, I_C=0$	5			V
Collector cut-off current	$I_{CB0}$	$V_{CB}=40\text{V}, I_E=0$			0.1	$\mu\text{A}$
Collector cut-off current	$I_{CEO}$	$V_{CB}=20\text{V}, I_E=0$			0.1	$\mu\text{A}$
Emitter cut-off current	$I_{EBO}$	$V_{EB}=5\text{V}, I_C=0$			0.1	$\mu\text{A}$
DC current gain	$h_{FE(1)}$	$V_{CE}=1\text{V}, I_C=100\text{mA}$	120		400	
	$h_{FE(2)}$	$V_{CE}=1\text{V}, I_C=800\text{mA}$	40			
Collector-emitter saturation voltage	$V_{CE(sat)}$	$I_C=800\text{mA}, I_B=80\text{mA}$			0.5	V
Base-emitter saturation voltage	$V_{BE(sat)}$	$I_C=800\text{mA}, I_B=80\text{mA}$			1.2	V
Transition frequency	$f_T$	$V_{CE}=10\text{V}, I_C=50\text{mA}$ $f=30\text{MHz}$	100			MHz

## CLASSIFICATION OF $h_{FE}$

RANK	L	H	J
RANGE	120 - 200	200 - 350	300 - 400

TYPICAL CHARACTERISTICS

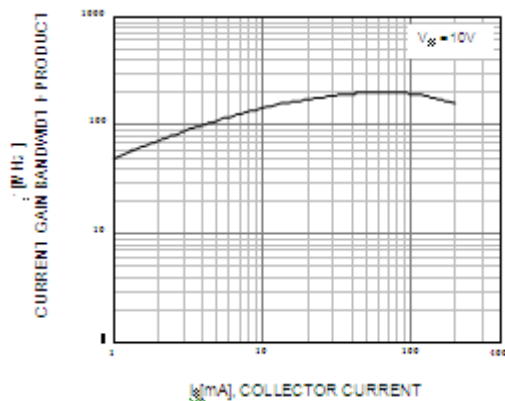
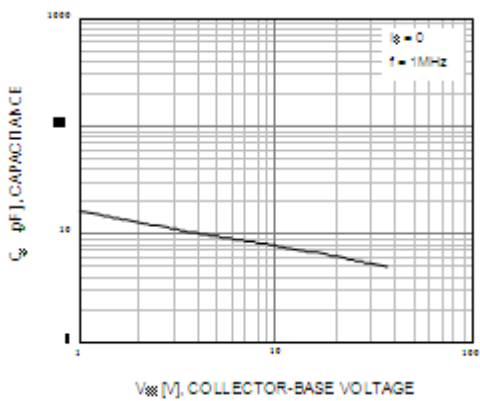
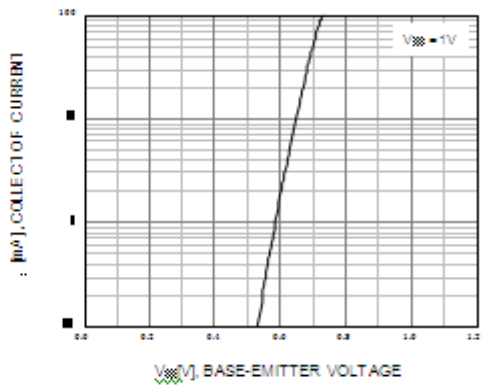
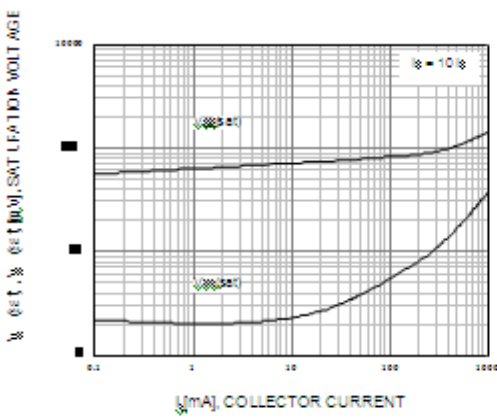
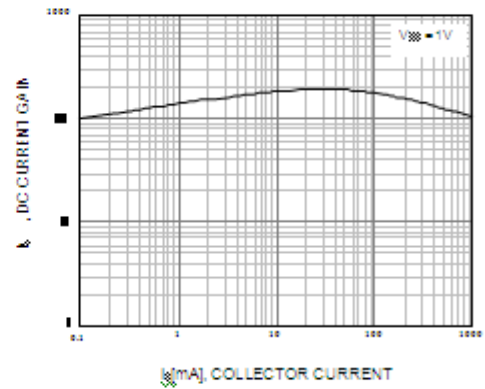
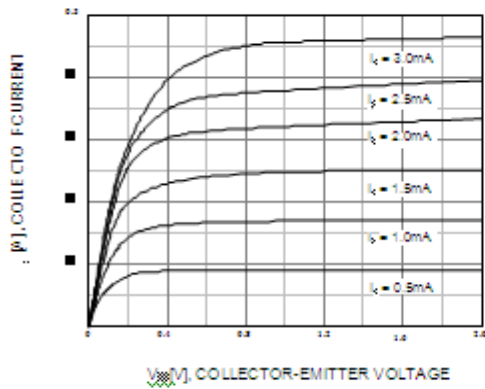

PACKAGE OUTLINE

Plastic surface mounted package; 3 leads

SOT-323

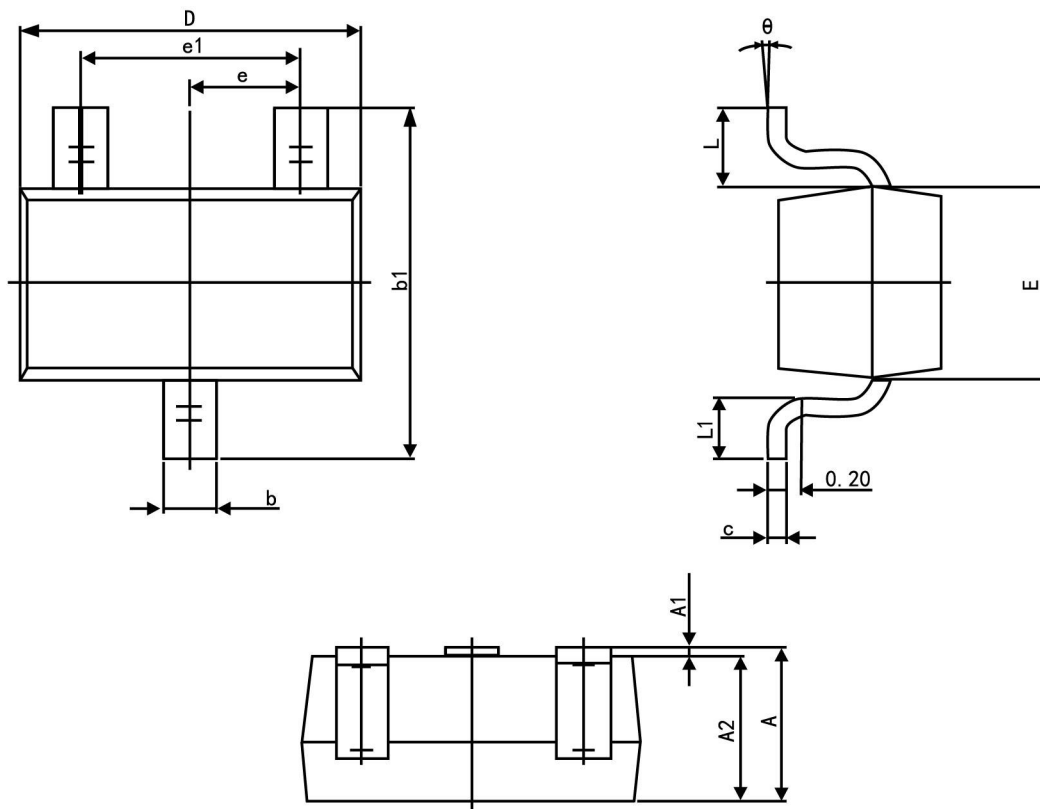

Symbol	Dimension in Millimeters	
	Min	Max
A	0.900	1.100
A1	0.000	0.100
A2	0.900	1.000
b	0.200	0.400
c	0.080	0.150
D	2.000	2.200
E	1.150	1.350
E1	2.150	2.450
e	0.650 TYP.	
e1	1.200	1.400
L	0.525 REF.	
L1	0.260	0.460
θ	0°	8°