

## MMBT3904W TRANSISTOR(NPN)

for switching and amplifier applications

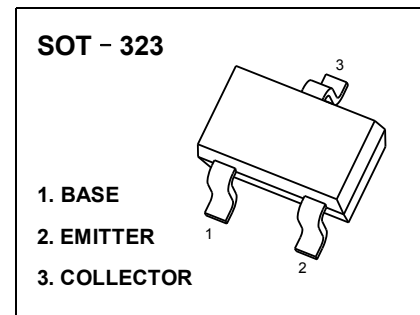

### MAXIMUM RATINGS ( $T_A=25^{\circ}\text{C}$ unless otherwise noted)

Parameter	Symbol	Value	Unit
Collector Base Voltage	$V_{CBO}$	60	V
Collector Emitter Voltage	$V_{CEO}$	40	V
Emitter Base Voltage	$V_{EBO}$	6	V
Collector Current	$I_C$	200	mA
Total Power Dissipation	$P_{tot}$	200	mW
Junction Temperature	$T_j$	150	$^{\circ}\text{C}$
Storage Temperature Range	$T_{stg}$	- 55 to + 150	$^{\circ}\text{C}$

**ELECTRICAL CHARACTERISTICS (Ta=25°C unless otherwise specified)**

Parameter	Symbol	Min.	Max.	Unit
DC Current Gain at $V_{CE} = 1\text{ V}$ , $I_C = 0.1\text{ mA}$	$h_{FE}$	40	-	-
at $V_{CE} = 1\text{ V}$ , $I_C = 1\text{ mA}$	$h_{FE}$	70	-	-
at $V_{CE} = 1\text{ V}$ , $I_C = 10\text{ mA}$	$h_{FE}$	100	300	-
at $V_{CE} = 1\text{ V}$ , $I_C = 50\text{ mA}$	$h_{FE}$	60	-	-
at $V_{CE} = 1\text{ V}$ , $I_C = 100\text{ mA}$	$h_{FE}$	30	-	-
Collector Emitter Cutoff Current at $V_{CE} = 30\text{ V}$	$I_{CES}$	-	50	nA
Emitter Base Cutoff Current at $V_{EB} = 3\text{ V}$	$I_{EBO}$	-	50	nA
Collector Base Breakdown Voltage at $I_C = 10\text{ }\mu\text{A}$	$V_{(BR)CBO}$	60	-	V
Collector Emitter Breakdown Voltage at $I_C = 1\text{ mA}$	$V_{(BR)CEO}$	40	-	V
Emitter Base Breakdown Voltage at $I_E = 10\text{ }\mu\text{A}$	$V_{(BR)EBO}$	6	-	V
Collector Emitter Saturation Voltage at $I_C = 10\text{ mA}$ , $I_B = 1\text{ mA}$	$V_{CE(sat)}$	-	0.2	V
at $I_C = 50\text{ mA}$ , $I_B = 5\text{ mA}$		-	0.3	
Base Emitter Saturation Voltage at $I_C = 10\text{ mA}$ , $I_B = 1\text{ mA}$	$V_{BE(sat)}$	0.65	0.85	V
at $I_C = 50\text{ mA}$ , $I_B = 5\text{ mA}$		-	0.95	
Transition Frequency at $V_{CE} = 20\text{ V}$ , $-I_E = 10\text{ mA}$ , $f = 100\text{ MHz}$	$f_T$	300	-	MHz
Collector Output Capacitance at $V_{CB} = 10\text{ V}$ , $f = 100\text{ KHz}$	$C_{ob}$	-	4	pF
Delay Time at $V_{CC} = 3\text{ V}$ , $V_{BE(OFF)} = 0.5\text{ V}$ , $I_C = 10\text{ mA}$ , $I_{B1} = 1\text{ mA}$	$t_d$	-	35	ns
Rise Time at $V_{CC} = 3\text{ V}$ , $V_{BE(OFF)} = 0.5\text{ V}$ , $I_C = 10\text{ mA}$ , $I_{B1} = 1\text{ mA}$	$t_r$	-	35	ns
Storage Time at $V_{CC} = 3\text{ V}$ , $I_C = 10\text{ mA}$ , $I_{B1} = -I_{B2} = 1\text{ mA}$	$t_{stg}$	-	200	ns
Fall Time at $V_{CC} = 3\text{ V}$ , $I_C = 10\text{ mA}$ , $I_{B1} = -I_{B2} = 1\text{ mA}$	$t_f$	-	50	ns

TYPICAL CHARACTERISTICS

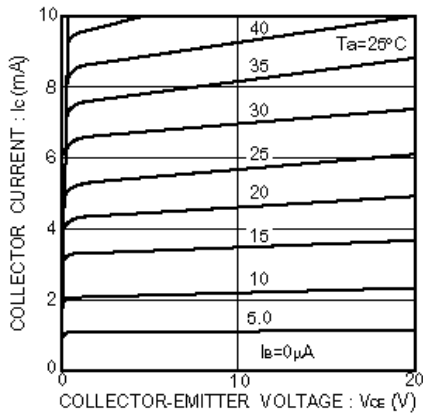

Fig.1 Grounded emitter output characteristics

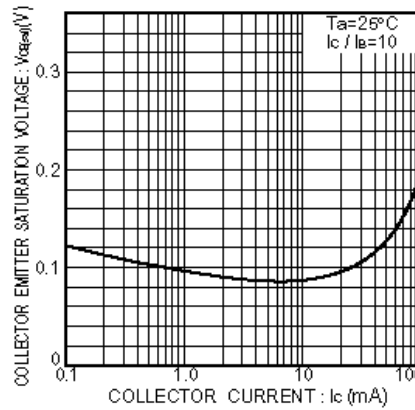

Fig.2 Collector-emitter saturation voltage vs. collector current

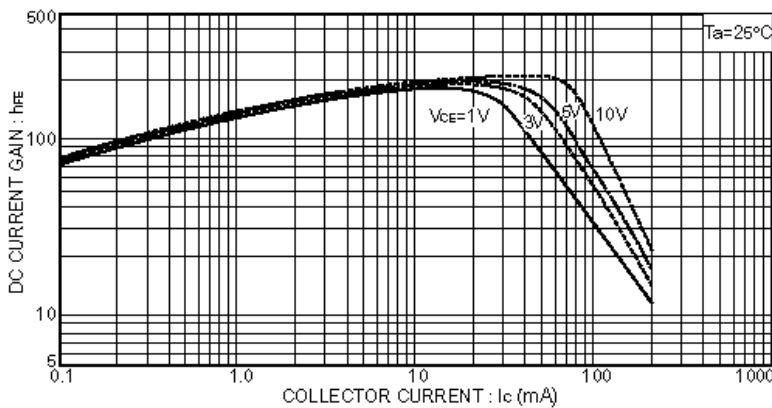

Fig.3 DC current gain vs. collector current ( I )

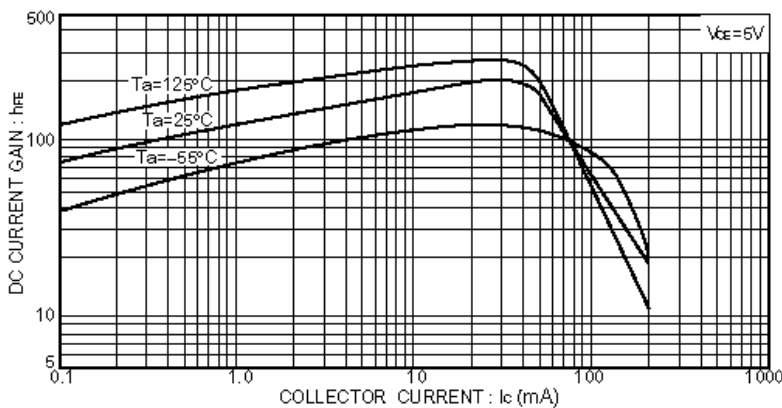

Fig.4 DC current gain vs. collector current ( II )

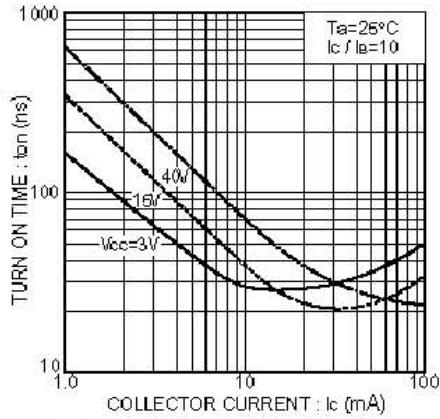

Fig. 5 Turn-on time vs. collector current

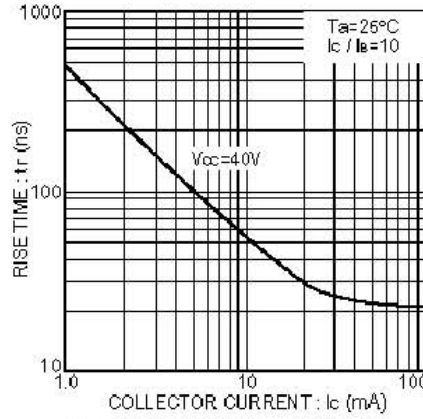

Fig. 6 Rise time vs. collector current

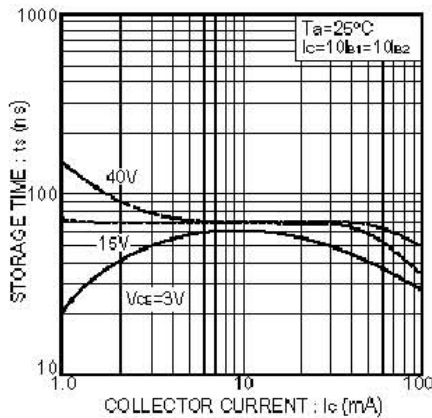

Fig. 7 Storage time vs. collector current

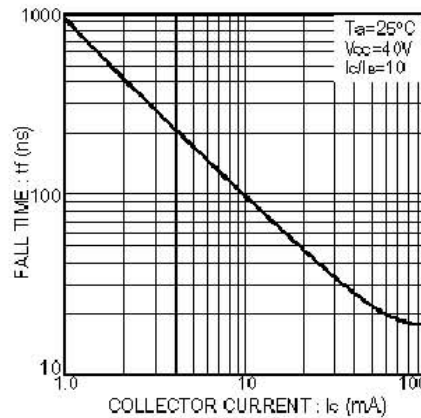

Fig. 8 Fall time vs. collector current

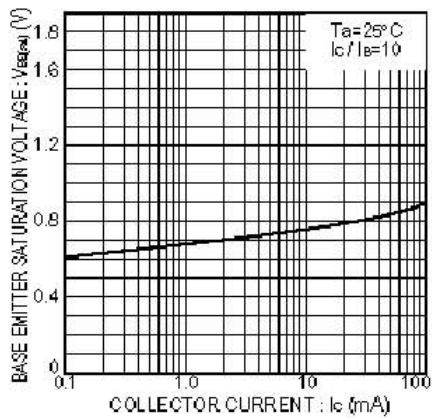

Fig. 9 Base-emitter saturation voltage vs. collector current

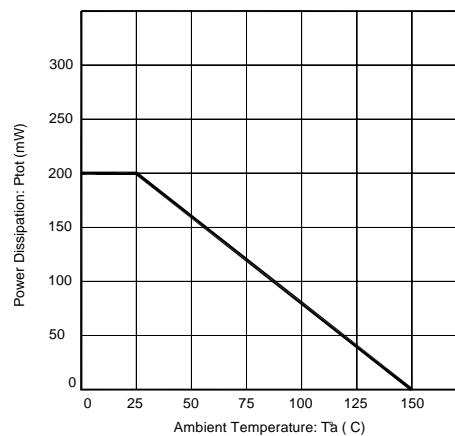
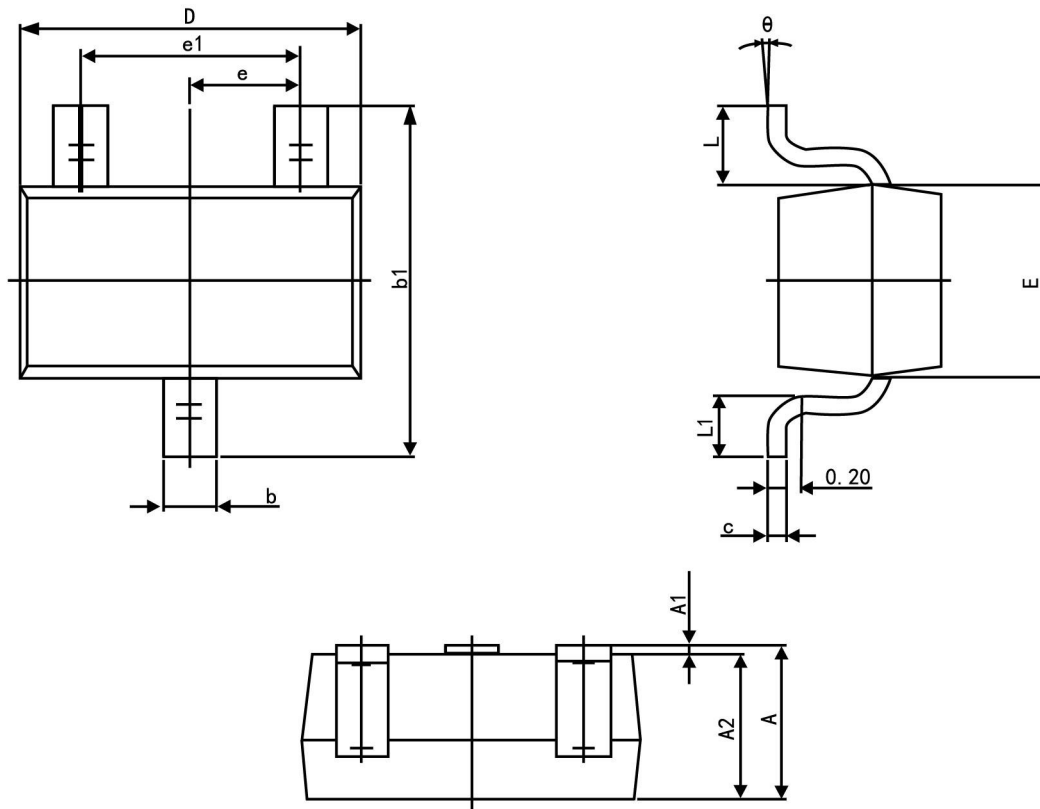

Fig. 10 Power Dissipation vs Ambient Temperature

PACKAGE OUTLINE

Plastic surface mounted package; 3 leads

SOT-323



Symbol	Dimension in Millimeters	
	Min	Max
A	0.900	1.100
A1	0.000	0.100
A2	0.900	1.000
b	0.200	0.400
c	0.080	0.150
D	2.000	2.200
E	1.150	1.350
E1	2.150	2.450
e	0.650 TYP.	
e1	1.200	1.400
L	0.525 REF.	
L1	0.260	0.460
$\theta$	0°	8°