

# RF Power Field Effect Transistor

## N-Channel Enhancement-Mode Lateral MOSFET

Designed for broadband commercial and industrial applications with frequencies up to 1000 MHz. The high gain and broadband performance of this device makes it ideal for large-signal, common-source amplifier applications in 28 volt base station equipment.

- Typical Single-Carrier N-CDMA Performance @ 880 MHz,  $V_{DD} = 28$  Volts,  $I_{DQ} = 450$  mA,  $P_{out} = 14$  Watts Avg., IS-95 CDMA (Pilot, Sync, Paging, Traffic Codes 8 Through 13) Channel Bandwidth = 1.2288 MHz. PAR = 9.8 dB @ 0.01% Probability on CCDF.  
 Power Gain — 21.1 dB  
 Drain Efficiency — 33%  
 ACPR @ 750 kHz Offset — -45.7 dBc in 30 kHz Channel Bandwidth
- Capable of Handling 10:1 VSWR, @ 32 Vdc, 880 MHz, 3 dB Overdrive, Designed for Enhanced Ruggedness

### GSM EDGE Application

- Typical GSM EDGE Performance:  $V_{DD} = 28$  Volts,  $I_{DQ} = 500$  mA,  $P_{out} = 21$  Watts Avg., Full Frequency Band (920-960 MHz)  
 Power Gain — 20 dB  
 Drain Efficiency — 46%  
 Spectral Regrowth @ 400 kHz Offset = -62 dBc  
 Spectral Regrowth @ 600 kHz Offset = -78 dBc  
 EVM — 1.5% rms

### GSM Application

- Typical GSM Performance:  $V_{DD} = 28$  Volts,  $I_{DQ} = 500$  mA,  $P_{out} = 60$  Watts, Full Frequency Band (920-960 MHz)  
 Power Gain — 20 dB  
 Drain Efficiency — 63%

### Features

- Characterized with Series Equivalent Large-Signal Impedance Parameters
- Integrated ESD Protection
- 225°C Capable Plastic Package
- RoHS Compliant
- In Tape and Reel. R1 Suffix = 500 Units per 24 mm, 13 inch Reel.

**Table 1. Maximum Ratings**

| Rating                               | Symbol    | Value        | Unit |
|--------------------------------------|-----------|--------------|------|
| Drain-Source Voltage                 | $V_{DSS}$ | - 0.5, +66   | Vdc  |
| Gate-Source Voltage                  | $V_{GS}$  | - 0.5, +12   | Vdc  |
| Maximum Operation Voltage            | $V_{DD}$  | 32, +0       | Vdc  |
| Storage Temperature Range            | $T_{stg}$ | - 65 to +150 | °C   |
| Case Operating Temperature           | $T_C$     | 150          | °C   |
| Operating Junction Temperature (1,2) | $T_J$     | 225          | °C   |

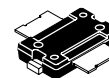
**Table 2. Thermal Characteristics**

| Characteristic   | Symbol          | Value (2,3)  | Unit |
|--|-----------------|--------------|------|
| Thermal Resistance, Junction to Case<br>Case Temperature 80°C, 60 W CW<br>Case Temperature 78°C, 14 W CW | $R_{\theta JC}$ | 0.77<br>0.88 | °C/W |

1. Continuous use at maximum temperature will affect MTTF.
2. MTTF calculator available at <http://www.freescale.com/rf>. Select Tools (Software & Tools)/Calculators to access MTTF calculators by product.
3. Refer to AN1955, *Thermal Measurement Methodology of RF Power Amplifiers*. Go to <http://www.freescale.com/rf>. Select Documentation/Application Notes - AN1955.

**MRFE6S9060NR1**

**880 MHz, 14 W AVG., 28 V  
 SINGLE N-CDMA  
 LATERAL N-CHANNEL  
 BROADBAND  
 RF POWER MOSFET**



**CASE 1265-09, STYLE 1  
 TO-270-2  
 PLASTIC**

**Table 3. ESD Protection Characteristics**

| Test Methodology                      | Class         |
|---------------------------------------|---------------|
| Human Body Model (per JESD22-A114)    | 2 (Minimum)   |
| Machine Model (per EIA/JESD22-A115)   | B (Minimum)   |
| Charge Device Model (per JESD22-C101) | III (Minimum) |

**Table 4. Moisture Sensitivity Level**

| Test Methodology                      | Rating | Package Peak Temperature | Unit |
|---------------------------------------|--------|--------------------------|------|
| Per JESD 22-A113, IPC/JEDEC J-STD-020 | 3      | 260                      | °C   |

**Table 5. Electrical Characteristics** ( $T_C = 25^\circ\text{C}$  unless otherwise noted)

| Characteristic | Symbol | Min | Typ | Max | Unit |
|----------------|--------|-----|-----|-----|------|
|----------------|--------|-----|-----|-----|------|

**Off Characteristics**

|   |           |   |   |    |                 |
|---|-----------|---|---|----|-----------------|
| Zero Gate Voltage Drain Leakage Current<br>( $V_{DS} = 66\text{ Vdc}$ , $V_{GS} = 0\text{ Vdc}$ ) | $I_{DSS}$ | — | — | 10 | $\mu\text{Adc}$ |
| Zero Gate Voltage Drain Leakage Current<br>( $V_{DS} = 28\text{ Vdc}$ , $V_{GS} = 0\text{ Vdc}$ ) | $I_{DSS}$ | — | — | 1  | $\mu\text{Adc}$ |
| Gate-Source Leakage Current<br>( $V_{GS} = 5\text{ Vdc}$ , $V_{DS} = 0\text{ Vdc}$ )              | $I_{GSS}$ | — | — | 10 | $\mu\text{Adc}$ |

**On Characteristics**

|   |              |      |      |     |     |
|---|--------------|------|------|-----|-----|
| Gate Threshold Voltage<br>( $V_{DS} = 10\text{ Vdc}$ , $I_D = 200\ \mu\text{A}$ )                             | $V_{GS(th)}$ | 1    | 2.2  | 3   | Vdc |
| Gate Quiescent Voltage<br>( $V_{DD} = 28\text{ Vdc}$ , $I_D = 450\text{ mAdc}$ , Measured in Functional Test) | $V_{GS(Q)}$  | 2    | 3    | 4   | Vdc |
| Drain-Source On-Voltage<br>( $V_{GS} = 10\text{ Vdc}$ , $I_D = 1.5\text{ Adc}$ )                              | $V_{DS(on)}$ | 0.05 | 0.27 | 0.4 | Vdc |

**Dynamic Characteristics**

|   |           |   |     |   |    |
|---|-----------|---|-----|---|----|
| Reverse Transfer Capacitance<br>( $V_{DS} = 28\text{ Vdc} \pm 30\text{ mV(rms)ac}$ @ 1 MHz, $V_{GS} = 0\text{ Vdc}$ ) | $C_{rss}$ | — | 1.1 | — | pF |
| Output Capacitance<br>( $V_{DS} = 28\text{ Vdc} \pm 30\text{ mV(rms)ac}$ @ 1 MHz, $V_{GS} = 0\text{ Vdc}$ )           | $C_{oss}$ | — | 33  | — | pF |
| Input Capacitance<br>( $V_{DS} = 28\text{ Vdc}$ , $V_{GS} = 0\text{ Vdc} \pm 30\text{ mV(rms)ac}$ @ 1 MHz)            | $C_{iss}$ | — | 109 | — | pF |

**Functional Tests** (In Freescale Test Fixture, 50 ohm system)  $V_{DD} = 28\text{ Vdc}$ ,  $I_{DQ} = 450\text{ mA}$ ,  $P_{out} = 14\text{ W Avg.}$ ,  $f = 880\text{ MHz}$ , Single-Carrier N-CDMA, 1.2288 MHz Channel Bandwidth Carrier. ACPR measured in 30 kHz Channel Bandwidth @  $\pm 750\text{ kHz}$  Offset. PAR = 9.8 dB @ 0.01% Probability on CCDF

|                              |          |      |       |     |     |
|------------------------------|----------|------|-------|-----|-----|
| Power Gain                   | $G_{ps}$ | 20   | 21.1  | 23  | dB  |
| Drain Efficiency             | $\eta_D$ | 30.5 | 33    | —   | %   |
| Adjacent Channel Power Ratio | ACPR     | —    | -45.7 | -44 | dBc |
| Input Return Loss            | IRL      | —    | -18   | -9  | dB  |

(continued)

**Table 5. Electrical Characteristics** ( $T_C = 25^\circ\text{C}$  unless otherwise noted) (continued)

| Characteristic | Symbol | Min | Typ | Max | Unit |
|----------------|--------|-----|-----|-----|------|
|----------------|--------|-----|-----|-----|------|

**Typical GSM EDGE Performances** (In Freescale GSM EDGE Test Fixture Optimized for 920-960 MHz, 50 ohm system)  $V_{DD} = 28\text{ Vdc}$ ,  $I_{DQ} = 500\text{ mA}$ ,  $P_{out} = 21\text{ W Avg.}$ ,  $f = 920\text{ -}960\text{ MHz}$ , GSM EDGE Signal

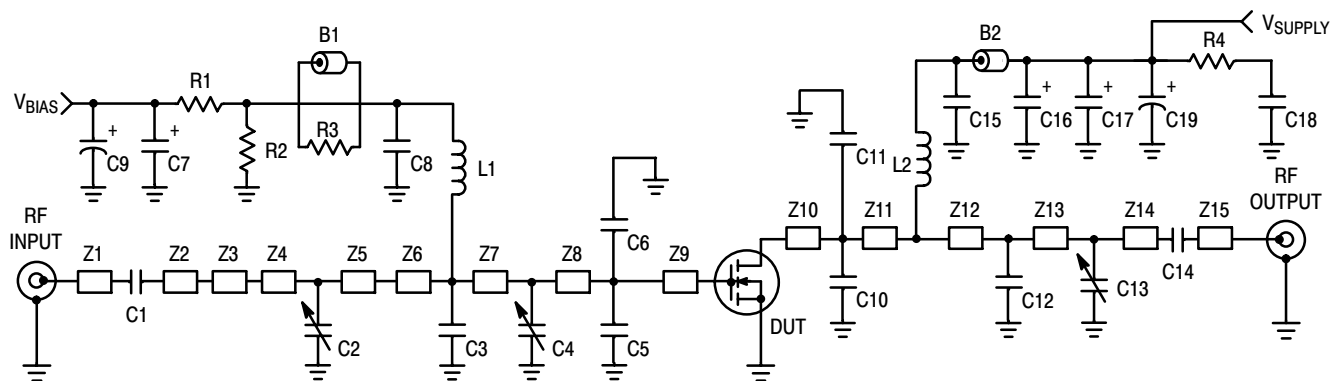
|                                     |          |   |     |   |     |
|-------------------------------------|----------|---|-----|---|-----|
| Power Gain                          | $G_{ps}$ | — | 20  | — | dB  |
| Drain Efficiency                    | $\eta_D$ | — | 46  | — | %   |
| Error Vector Magnitude              | EVM      | — | 1.5 | — | %   |
| Spectral Regrowth at 400 kHz Offset | SR1      | — | -62 | — | dBc |
| Spectral Regrowth at 600 kHz Offset | SR2      | — | -78 | — | dBc |

**Typical CW Performances** (In Freescale GSM Test Fixture Optimized for 920-960 MHz, 50 ohm system)  $V_{DD} = 28\text{ Vdc}$ ,  $I_{DQ} = 500\text{ mA}$ ,  $P_{out} = 60\text{ W}$ ,  $f = 920\text{ -}960\text{ MHz}$

|  |          |   |     |   |    |
|--|----------|---|-----|---|----|
| Power Gain   | $G_{ps}$ | — | 20  | — | dB |
| Drain Efficiency   | $\eta_D$ | — | 63  | — | %  |
| Input Return Loss  | IRL      | — | -12 | — | dB |
| $P_{out}$ @ 1 dB Compression Point<br>( $f = 940\text{ MHz}$ ) | P1dB     | — | 67  | — | W  |

**Typical Performances** (In Freescale Test Fixture, 50 ohm system)  $V_{DD} = 28\text{ Vdc}$ ,  $I_{DQ} = 450\text{ mA}$ , 865-900 MHz Bandwidth

|   |               |   |       |   |                       |
|---|---------------|---|-------|---|-----------------------|
| Video Bandwidth @ 60 W PEP $P_{out}$ where $IM3 = -30\text{ dBc}$<br>(Tone Spacing from 100 kHz to VBW)<br>$\Delta IMD3 = IMD3$ @ VBW frequency - $IMD3$ @ 100 kHz $<1\text{ dBc}$ (both sidebands) | VBW           | — | 3     | — | MHz                   |
| Gain Flatness in 35 MHz Bandwidth @ $P_{out} = 14\text{ W Avg.}$  | $G_F$         | — | 0.27  | — | dB                    |
| Gain Variation over Temperature<br>( $-30^\circ\text{C}$ to $+85^\circ\text{C}$ )   | $\Delta G$    | — | 0.011 | — | dB/ $^\circ\text{C}$  |
| Output Power Variation over Temperature<br>( $-30^\circ\text{C}$ to $+85^\circ\text{C}$ )   | $\Delta P1dB$ | — | 0.088 | — | dBm/ $^\circ\text{C}$ |



|    |                                |     |  |
|----|--------------------------------|-----|--|
| Z1 | 0.215" x 0.065" Microstrip     | Z9  | 0.057" x 0.525" Microstrip               |
| Z2 | 0.221" x 0.065" Microstrip     | Z10 | 0.360" x 0.270" Microstrip               |
| Z3 | 0.500" x 0.100" Microstrip     | Z11 | 0.063" x 0.270" Microstrip               |
| Z4 | 0.460" x 0.270" Microstrip     | Z12 | 0.360" x 0.065" Microstrip               |
| Z5 | 0.040" x 0.270" Microstrip     | Z13 | 0.170" x 0.065" Microstrip               |
| Z6 | 0.280" x 0.270" x 0.530" Taper | Z14 | 0.880" x 0.065" Microstrip               |
| Z7 | 0.087" x 0.525" Microstrip     | Z15 | 0.260" x 0.065" Microstrip               |
| Z8 | 0.435" x 0.525" Microstrip     | PCB | Taconic RF-35 0.030", $\epsilon_r = 3.5$ |

**Figure 1. MRFE6S9060NR1 Test Circuit Schematic**

**Table 6. MRFE6S9060NR1 Test Circuit Component Designations and Values**

| Part             | Description                                | Part Number         | Manufacturer |
|------------------|--|---------------------|--------------|
| B1               | Ferrite Bead                               | 2743019447          | Fair Rite    |
| B2               | Ferrite Bead                               | 274021447           | Fair Rite    |
| C1, C8, C14, C15 | 47 pF Chip Capacitors                      | ATC100B470JT500XT   | ATC          |
| C2, C4, C13      | 0.8 - 8.0 pF Variable Capacitors, Gigatrim | 2729152             | Johanson     |
| C3               | 3.0 pF Chip Capacitor                      | ATC100B3R0JT500XT   | ATC          |
| C5, C6           | 15 pF Chip Capacitors                      | ATC100B150JT500XT   | ATC          |
| C7, C16, C17     | 10 $\mu$ F, 35 V Tantalum Capacitors       | T491D106K035AT      | Kemet        |
| C9               | 100 $\mu$ F, 50 V Electrolytic Capacitor   | MCHT101M1HB-1017-RH | Multicomp    |
| C10, C11         | 12 pF Chip Capacitors                      | ATC100B120JT500XT   | ATC          |
| C12              | 4.3 pF Chip Capacitor                      | ATC100B4R3JT500XT   | ATC          |
| C18              | 0.56 $\mu$ F Chip Capacitor                | ATC700A561MT150XT   | ATC          |
| C19              | 470 $\mu$ F, 63 V Electrolytic Capacitor   | EKME630ELL471MK255  | Multicomp    |
| L1, L2           | 12.5 nH Inductor                           | A04T-5              | Coilcraft    |
| R1               | 1 k $\Omega$ , 1/4 W Chip Resistor         | CRCW12061001FKEA    | Vishay       |
| R2               | 560 k $\Omega$ , 1/4 W Chip Resistor       | CRCW12065600FKEA    | Vishay       |
| R3               | 12 $\Omega$ , 1/4 W Chip Resistor          | CRCW120612R0FKEA    | Vishay       |
| R4               | 27 $\Omega$ , 1/4 W Chip Resistor          | CRCW120627R0FKEA    | Vishay       |

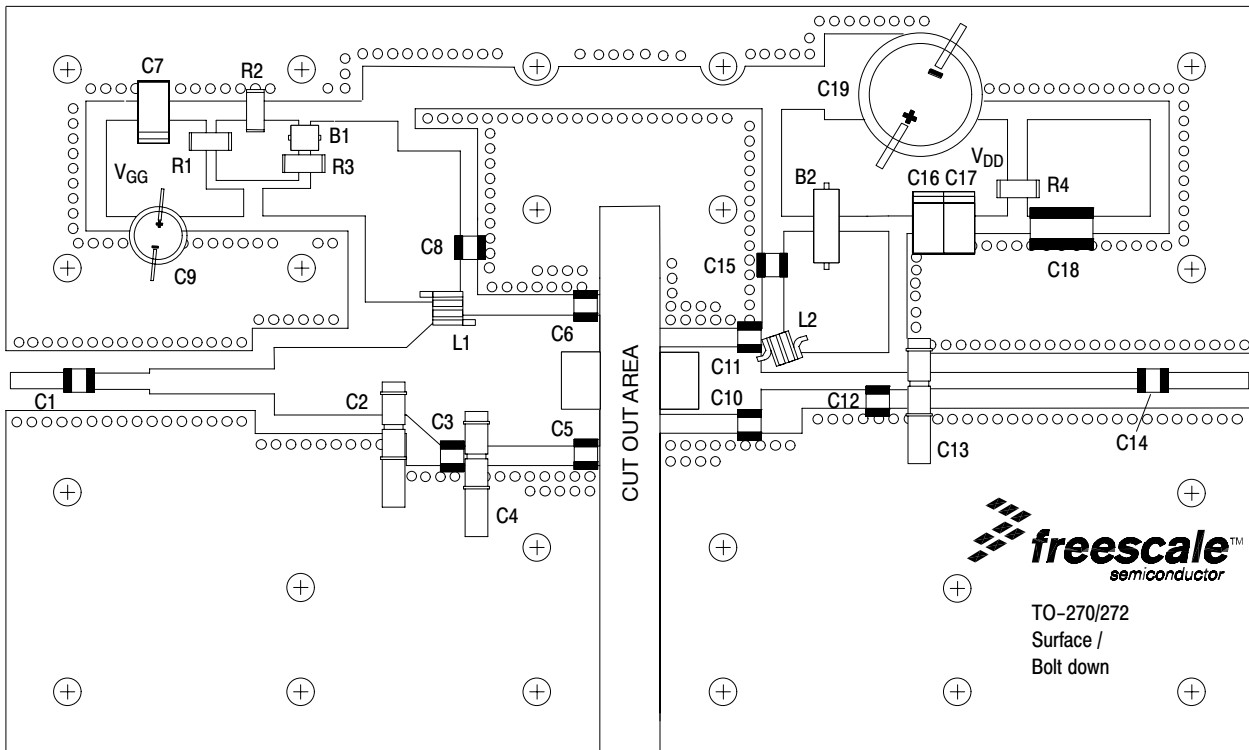
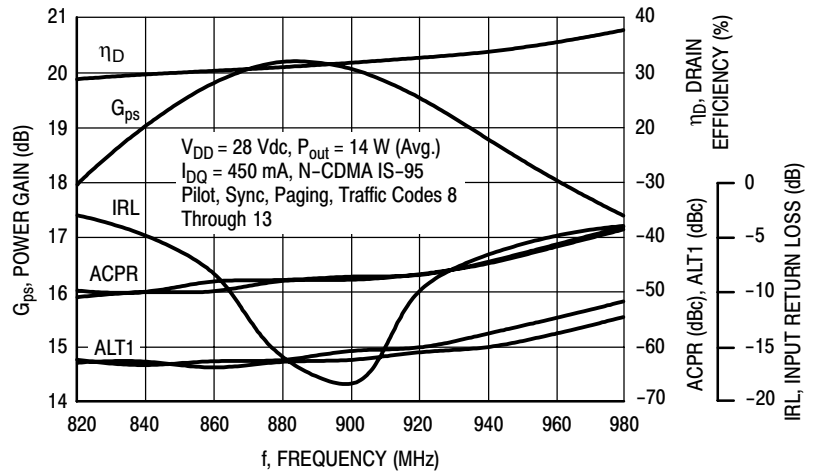
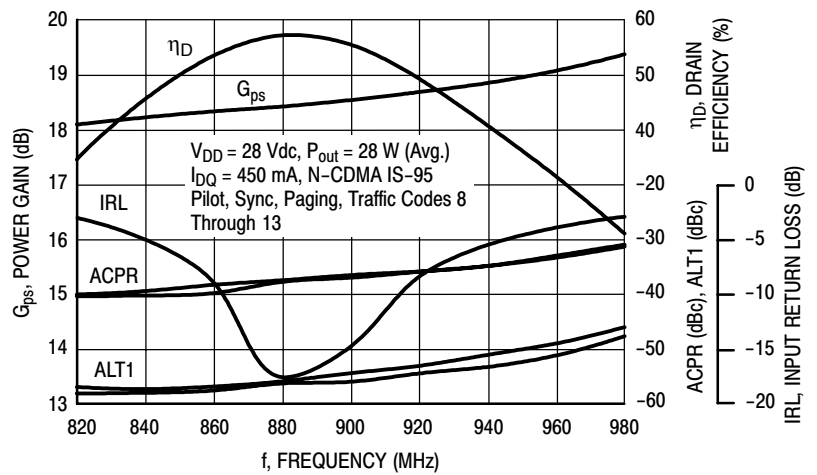


Figure 2. MRFE6S9060NR1 Test Circuit Component Layout

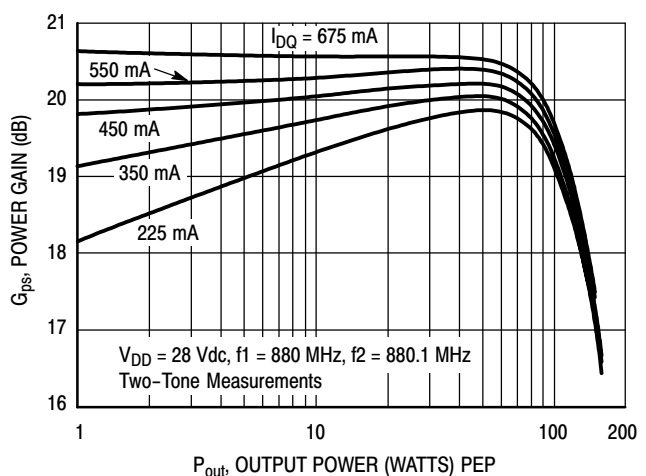
### TYPICAL CHARACTERISTICS



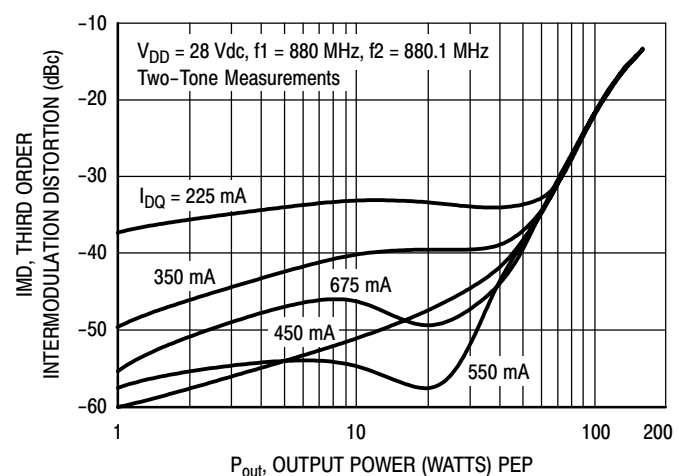
**Figure 3. Single-Carrier N-CDMA Broadband Performance @  $P_{out} = 14$  Watts Avg.**



**Figure 4. Single-Carrier N-CDMA Broadband Performance @  $P_{out} = 28$  Watts Avg.**

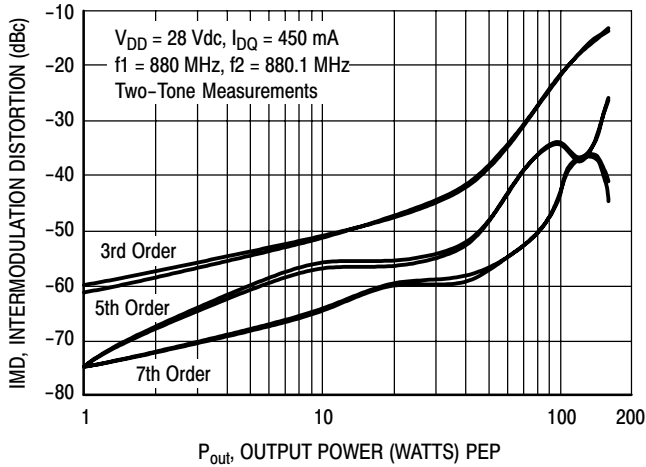


**Figure 5. Two-Tone Power Gain versus Output Power**

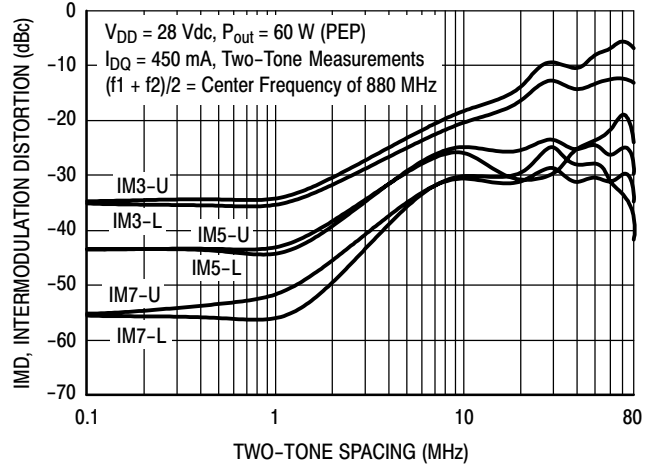


**Figure 6. Third Order Intermodulation Distortion versus Output Power**

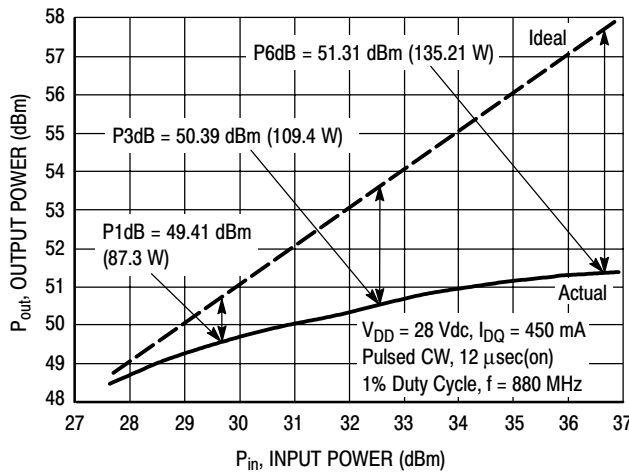
### TYPICAL CHARACTERISTICS



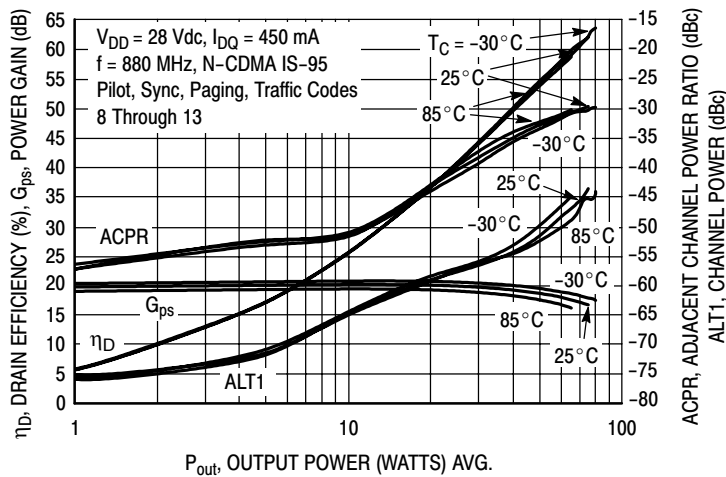
**Figure 7. Intermodulation Distortion Products versus Output Power**



**Figure 8. Intermodulation Distortion Products versus Tone Spacing**

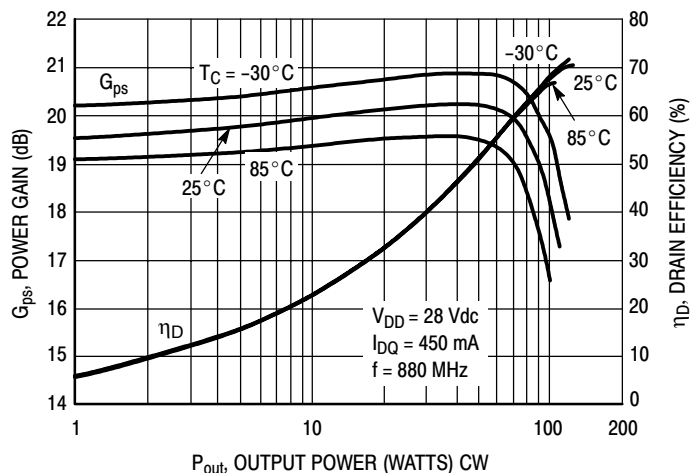


**Figure 9. Pulsed CW Output Power versus Input Power**

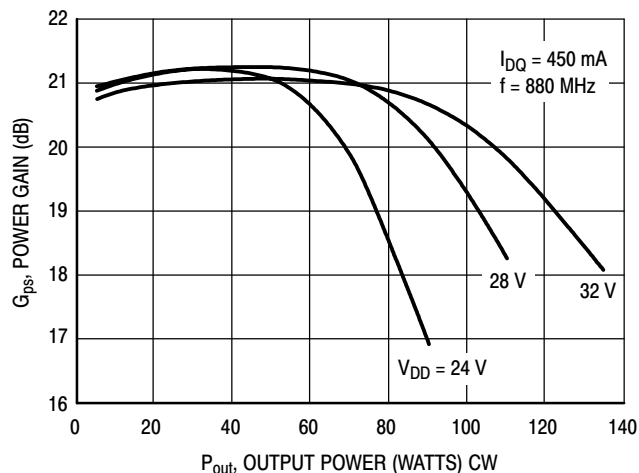


**Figure 10. Single-Carrier N-CDMA ACPR, ALT1, Power Gain and Drain Efficiency versus Output Power**

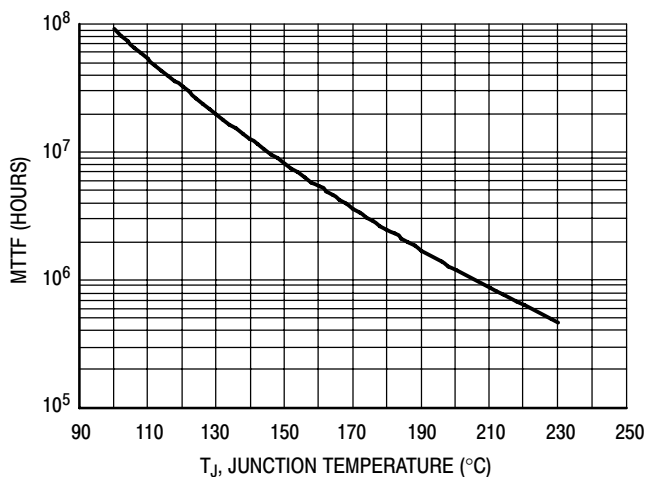
### TYPICAL CHARACTERISTICS



**Figure 11. Power Gain and Drain Efficiency versus CW Output Power**



**Figure 12. Power Gain versus Output Power**



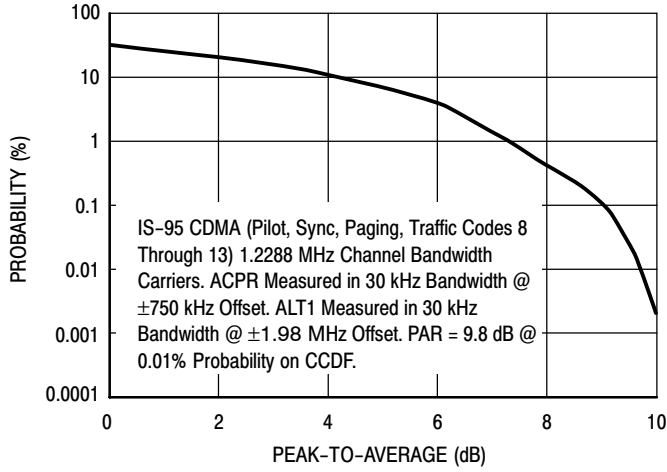
This above graph displays calculated MTTF in hours when the device is operated at  $V_{DD} = 28 \text{ Vdc}$ ,  $P_{out} = 14 \text{ W Avg.}$ , and  $\eta_D = 32.5\%$ .

MTTF calculator available at <http://www.freescale.com/rf>. Select Tools (Software & Tools)/Calculators to access MTTF calculators by product.

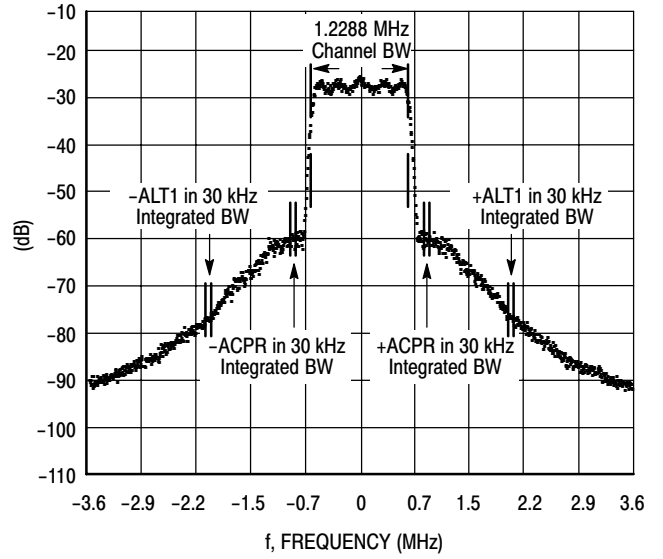
**Figure 13. MTTF versus Junction Temperature**



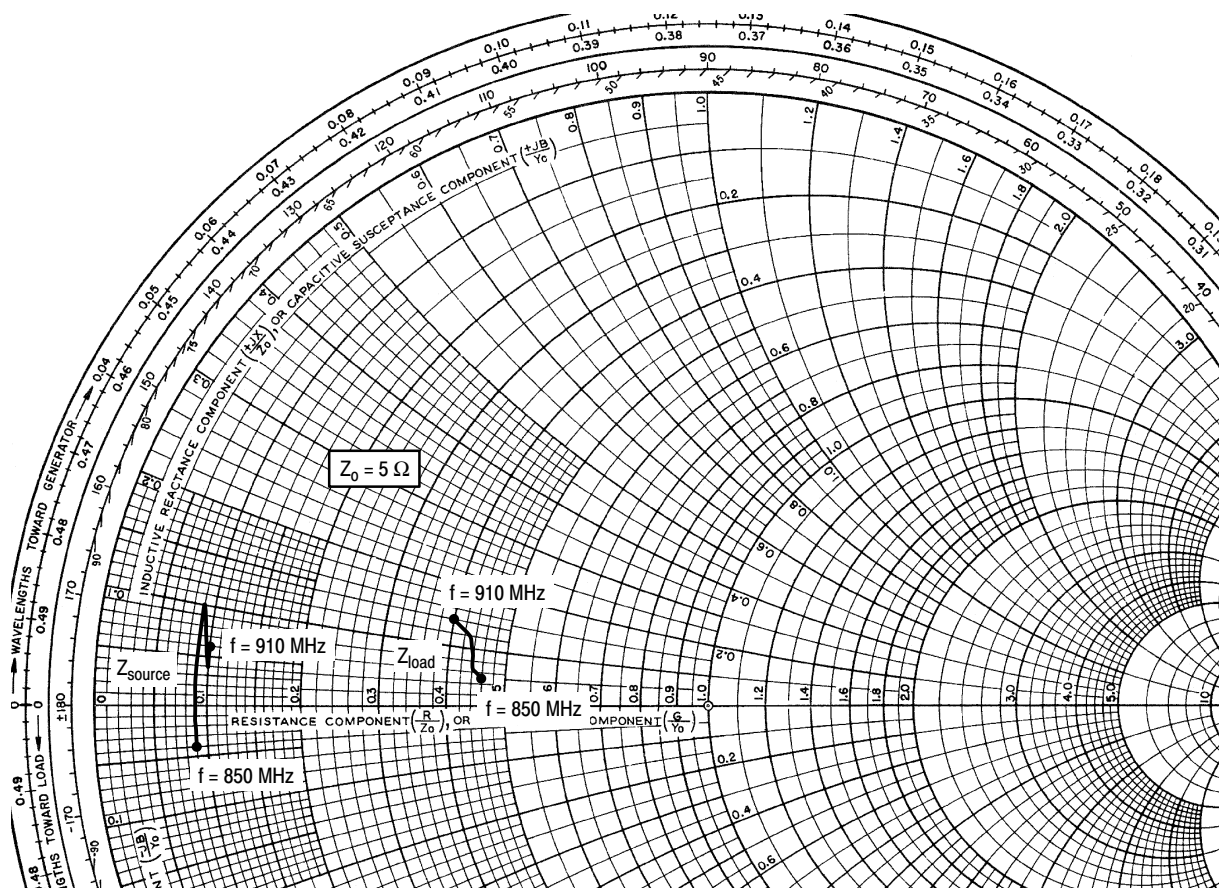
## N-CDMA TEST SIGNAL



**Figure 14. Single-Carrier CCDF N-CDMA**



**Figure 15. Single-Carrier N-CDMA Spectrum**



$V_{DD} = 28 \text{ Vdc}$ ,  $I_{DQ} = 450 \text{ mA}$ ,  $P_{out} = 14 \text{ W Avg.}$

| f<br>MHz | $Z_{source}$<br>$\Omega$ | $Z_{load}$<br>$\Omega$ |
|----------|--------------------------|------------------------|
| 850      | $0.44 - j0.20$           | $2.28 + j0.23$         |
| 865      | $0.44 - j0.07$           | $2.18 + j0.33$         |
| 880      | $0.45 + j0.50$           | $2.20 + j0.47$         |
| 895      | $0.48 + j0.18$           | $2.15 + j0.61$         |
| 910      | $0.52 + j0.29$           | $2.00 + j0.68$         |

$Z_{source}$  = Test circuit impedance as measured from gate to ground.

$Z_{load}$  = Test circuit impedance as measured from drain to ground.

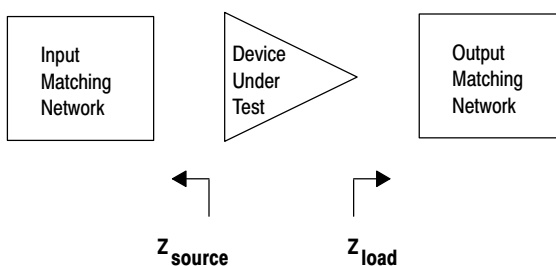
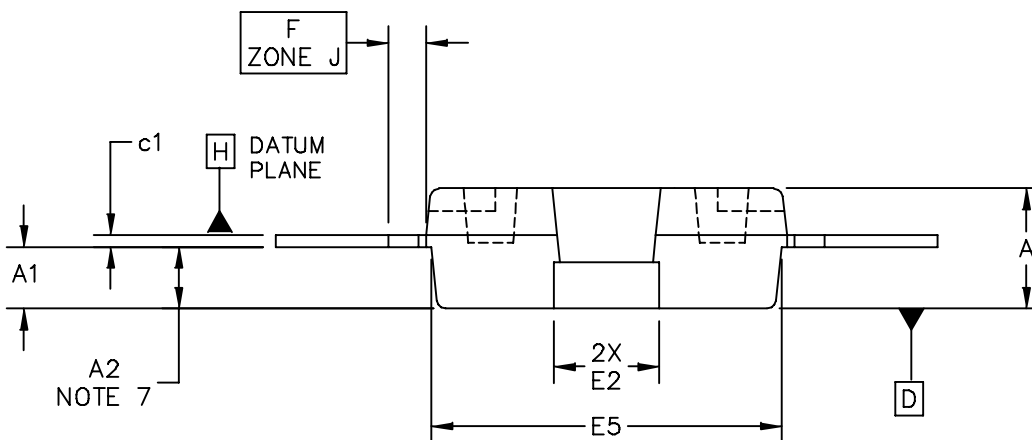
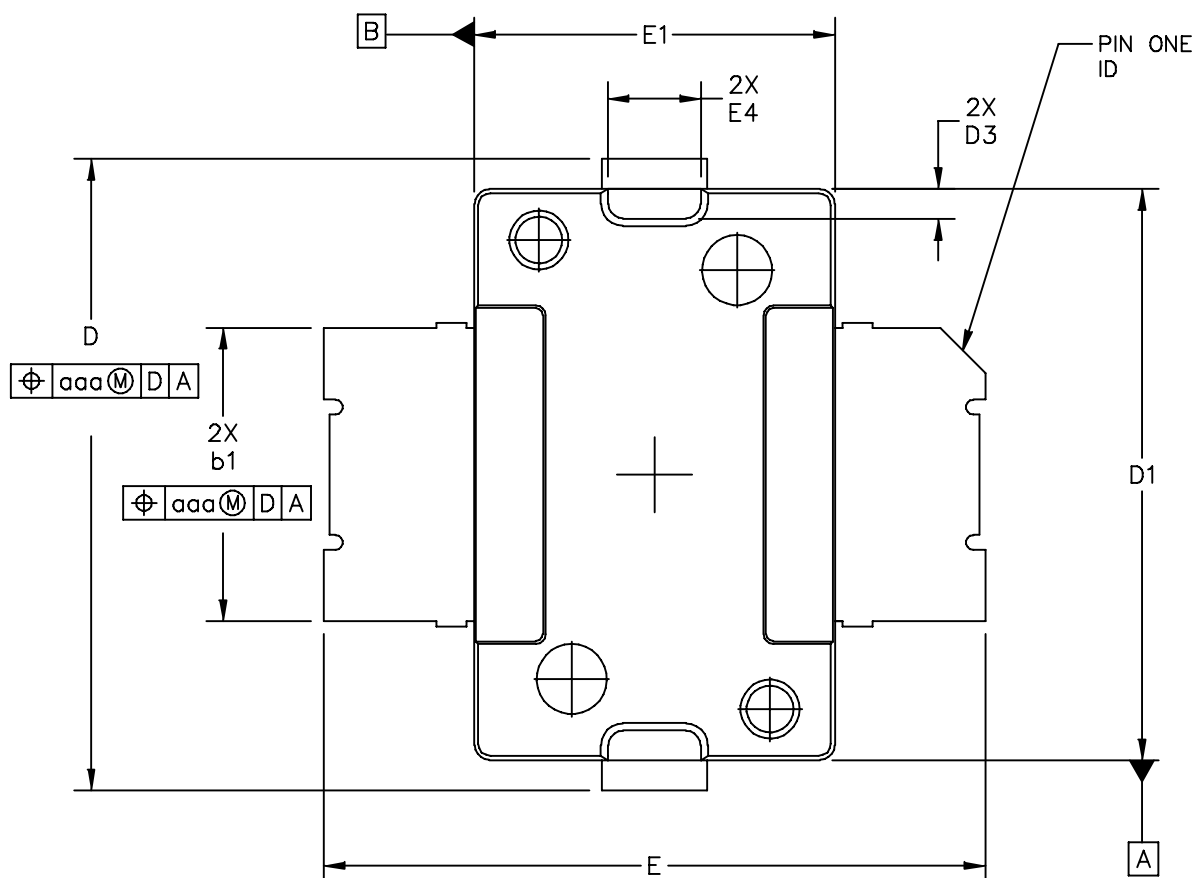
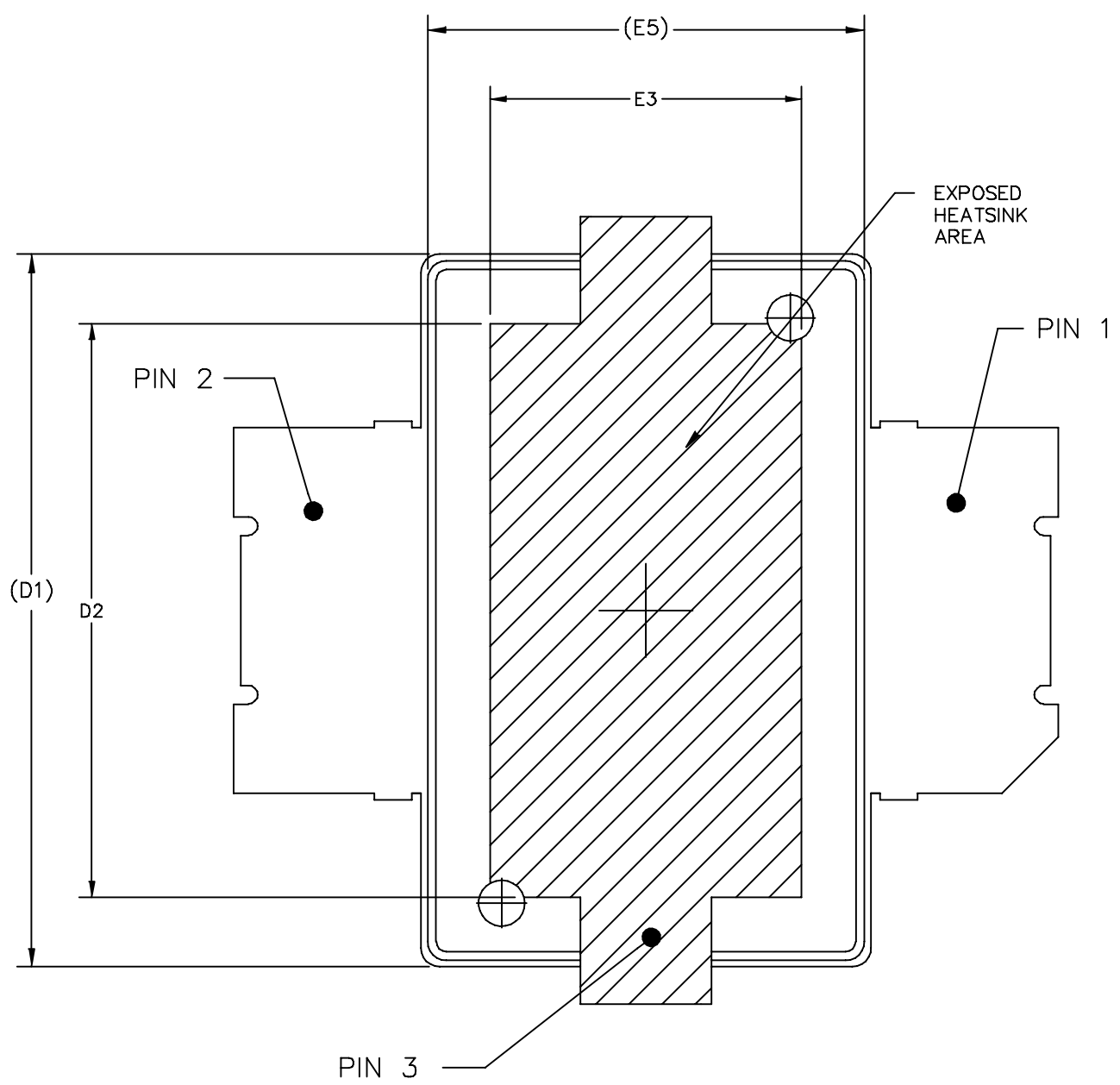


Figure 16. Series Equivalent Source and Load Impedance

**PACKAGE DIMENSIONS**



|   |  |                           |  |                            |  |
|---|--|---------------------------|--|----------------------------|--|
| © FREESCALE SEMICONDUCTOR, INC.<br>ALL RIGHTS RESERVED. |  | MECHANICAL OUTLINE        |  | PRINT VERSION NOT TO SCALE |  |
| TITLE:<br>TO-270<br>SURFACE MOUNT                       |  | DOCUMENT NO: 98ASH98117A  |  | REV: K                     |  |
|   |  | CASE NUMBER: 1265-09      |  | 29 JUN 2007                |  |
|   |  | STANDARD: JEDEC TO-270 AA |  |                            |  |



BOTTOM VIEW

|   |                           |                            |  |
|---|---------------------------|----------------------------|--|
| © FREESCALE SEMICONDUCTOR, INC.<br>ALL RIGHTS RESERVED. | MECHANICAL OUTLINE        | PRINT VERSION NOT TO SCALE |  |
| TITLE:<br><br>TO-270<br>SURFACE MOUNT                   | DOCUMENT NO: 98ASH98117A  | REV: K                     |  |
|   | CASE NUMBER: 1265-09      | 29 JUN 2007                |  |
|   | STANDARD: JEDEC TO-270 AA |                            |  |

NOTES:

1. CONTROLLING DIMENSION: INCH
2. INTERPRET DIMENSIONS AND TOLERANCES PER ASME Y14.5M-1994.
3. DATUM PLANE -H- IS LOCATED AT TOP OF LEAD AND IS COINCIDENT WITH THE LEAD WHERE THE LEAD EXITS THE PLASTIC BODY AT THE TOP OF THE PARTING LINE.
4. DIMENSIONS "D1" AND "E1" DO NOT INCLUDE MOLD PROTRUSION. ALLOWABLE PROTRUSION IS .006 PER SIDE. DIMENSIONS "D1 AND "E1" DO INCLUDE MOLD MISMATCH AND ARE DETERMINED AT DATUM PLANE -H-.
5. DIMENSION "b1" DOES NOT INCLUDE DAMBAR PROTRUSION. ALLOWABLE DAMBAR PROTRUSION SHALL BE .005 TOTAL IN EXCESS OF THE "b1" DIMENSION AT MAXIMUM MATERIAL CONDITION.
6. DATUMS -A- AND -B- TO BE DETERMINED AT DATUM PLANE -H-.
7. DIMENSION "A2" APPLIES WITHIN ZONE "J" ONLY.
8. DIMENSIONS "D" AND "E2" DO NOT INCLUDE MOLD PROTRUSION. OVERALL LENGTH INCLUDING MOLD PROTRUSION SHOULD NOT EXCEED 0.430 INCH FOR DIMENSION "D" AND 0.080 INCH FOR DIMENSION "E2". DIMENSIONS "D" AND "E2" DO INCLUDE MOLD MISMATCH AND ARE DETERMINED AT DATUM PLANE -D-.

STYLE 1:

- PIN 1 - DRAIN
- PIN 2 - GATE
- PIN 3 - SOURCE

| DIM   | INCH |      | MILLIMETER         |       | DIM                       | INCH                       |      | MILLIMETER  |      |
|---|------|------|--------------------|-------|---------------------------|----------------------------|------|-------------|------|
|   | MIN  | MAX  | MIN                | MAX   |                           | MIN                        | MAX  | MIN         | MAX  |
| A   | .078 | .082 | 1.98               | 2.08  | F                         | .025 BSC                   |      | 0.64 BSC    |      |
| A1  | .039 | .043 | 0.99               | 1.09  | b1                        | .193                       | .199 | 4.90        | 5.06 |
| A2  | .040 | .042 | 1.02               | 1.07  | c1                        | .007                       | .011 | 0.18        | 0.28 |
| D   | .416 | .424 | 10.57              | 10.77 | aaa                       | .004                       |      | 0.10        |      |
| D1  | .378 | .382 | 9.60               | 9.70  |                           |                            |      |             |      |
| D2  | .290 | ---- | 7.37               | ----  |                           |                            |      |             |      |
| D3  | .016 | .024 | 0.41               | 0.61  |                           |                            |      |             |      |
| E   | .436 | .444 | 11.07              | 11.28 |                           |                            |      |             |      |
| E1  | .238 | .242 | 6.04               | 6.15  |                           |                            |      |             |      |
| E2  | .066 | .074 | 1.68               | 1.88  |                           |                            |      |             |      |
| E3  | .150 | ---- | 3.81               | ----  |                           |                            |      |             |      |
| E4  | .058 | .066 | 1.47               | 1.68  |                           |                            |      |             |      |
| E5  | .231 | .235 | 5.87               | 5.97  |                           |                            |      |             |      |
| © FREESCALE SEMICONDUCTOR, INC.<br>ALL RIGHTS RESERVED. |      |      | MECHANICAL OUTLINE |       |                           | PRINT VERSION NOT TO SCALE |      |             |      |
| TITLE:<br><br>TO-270<br>SURFACE MOUNT                   |      |      |                    |       | DOCUMENT NO: 98ASH98117A  |                            |      | REV: K      |      |
|   |      |      |                    |       | CASE NUMBER: 1265-09      |                            |      | 29 JUN 2007 |      |
|   |      |      |                    |       | STANDARD: JEDEC TO-270 AA |                            |      |             |      |

## PRODUCT DOCUMENTATION

Refer to the following documents to aid your design process.

### Application Notes

- AN1907: Solder Reflow Attach Method for High Power RF Devices in Plastic Packages
- AN1955: Thermal Measurement Methodology of RF Power Amplifiers
- AN3263: Bolt Down Mounting Method for High Power RF Transistors and RFICs in Over-Molded Plastic Packages

### Engineering Bulletins

- EB212: Using Data Sheet Impedances for RF LDMOS Devices

## REVISION HISTORY

The following table summarizes revisions to this document.

| Revision | Date      | Description  |
|----------|-----------|--|
| 0        | Oct. 2007 | <ul style="list-style-type: none"> <li>• Initial Release of Data Sheet</li> </ul>  |
| 1        | Oct. 2007 | <ul style="list-style-type: none"> <li>• Added Min value to <math>V_{DS(on)}</math>. On Characteristics table, p. 2</li> </ul> |

## **How to Reach Us:**

### **Home Page:**

[www.freescale.com](http://www.freescale.com)

### **Web Support:**

<http://www.freescale.com/support>

### **USA/Europe or Locations Not Listed:**

Freescale Semiconductor, Inc.  
Technical Information Center, EL516  
2100 East Elliot Road  
Tempe, Arizona 85284  
+1-800-521-6274 or +1-480-768-2130  
[www.freescale.com/support](http://www.freescale.com/support)

### **Europe, Middle East, and Africa:**

Freescale Halbleiter Deutschland GmbH  
Technical Information Center  
Schatzbogen 7  
81829 Muenchen, Germany  
+44 1296 380 456 (English)  
+46 8 52200080 (English)  
+49 89 92103 559 (German)  
+33 1 69 35 48 48 (French)  
[www.freescale.com/support](http://www.freescale.com/support)

### **Japan:**

Freescale Semiconductor Japan Ltd.  
Headquarters  
ARCO Tower 15F  
1-8-1, Shimo-Meguro, Meguro-ku,  
Tokyo 153-0064  
Japan  
0120 191014 or +81 3 5437 9125  
[support.japan@freescale.com](mailto:support.japan@freescale.com)

### **Asia/Pacific:**

Freescale Semiconductor Hong Kong Ltd.  
Technical Information Center  
2 Dai King Street  
Tai Po Industrial Estate  
Tai Po, N.T., Hong Kong  
+800 2666 8080  
[support.asia@freescale.com](mailto:support.asia@freescale.com)

### **For Literature Requests Only:**

Freescale Semiconductor Literature Distribution Center  
P.O. Box 5405  
Denver, Colorado 80217  
1-800-441-2447 or 303-675-2140  
Fax: 303-675-2150  
[LDCForFreescaleSemiconductor@hibbertgroup.com](mailto:LDCForFreescaleSemiconductor@hibbertgroup.com)

Information in this document is provided solely to enable system and software implementers to use Freescale Semiconductor products. There are no express or implied copyright licenses granted hereunder to design or fabricate any integrated circuits or integrated circuits based on the information in this document.

Freescale Semiconductor reserves the right to make changes without further notice to any products herein. Freescale Semiconductor makes no warranty, representation or guarantee regarding the suitability of its products for any particular purpose, nor does Freescale Semiconductor assume any liability arising out of the application or use of any product or circuit, and specifically disclaims any and all liability, including without limitation consequential or incidental damages. "Typical" parameters that may be provided in Freescale Semiconductor data sheets and/or specifications can and do vary in different applications and actual performance may vary over time. All operating parameters, including "Typicals", must be validated for each customer application by customer's technical experts. Freescale Semiconductor does not convey any license under its patent rights nor the rights of others. Freescale Semiconductor products are not designed, intended, or authorized for use as components in systems intended for surgical implant into the body, or other applications intended to support or sustain life, or for any other application in which the failure of the Freescale Semiconductor product could create a situation where personal injury or death may occur. Should Buyer purchase or use Freescale Semiconductor products for any such unintended or unauthorized application, Buyer shall indemnify and hold Freescale Semiconductor and its officers, employees, subsidiaries, affiliates, and distributors harmless against all claims, costs, damages, and expenses, and reasonable attorney fees arising out of, directly or indirectly, any claim of personal injury or death associated with such unintended or unauthorized use, even if such claim alleges that Freescale Semiconductor was negligent regarding the design or manufacture of the part.

Freescale™ and the Freescale logo are trademarks of Freescale Semiconductor, Inc. All other product or service names are the property of their respective owners.

© Freescale Semiconductor, Inc. 2007. All rights reserved.