

SCHOTTKY BARRIER DIODE

FEATURES

- Low Forward Voltage
- Surface Mount device
- For use in low voltage high frequency inverters and polarity protection applications

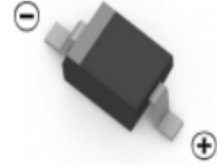

SOD-323

MECHANICAL DATA

- Case: SOD-323
- Case Material: Molded Plastic. UL flammability
- Classification Rating: 94V-0
- Weight: 0.005 grams (approximate)

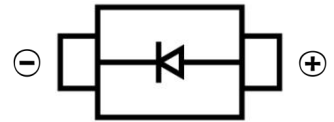

MAXIMUM RATINGS AND ELECTRICAL CHARACTERISTICS

Ratings at 25 °C ambient temperature unless otherwise specified.

Single phase, half wave, 60Hz, resistive or inductive load.

	1N5817WS	1N5818WS	1N5819WS	UNITS
Maximum Recurrent Peak Reverse Voltage	20	30	40	V
Maximum RMS Voltage	14	21	28	V
Maximum DC Blocking Voltage	20	30	40	V
Maximum Average Forward Rectified Current	1.0			A
Peak Forward Surge Current, 8.3ms single half sine wave superimposed on rated load (JECEC method) T _L =70 °C	9			A
Maximum Forward Voltage at 1.0A DC	0.45	0.55	0.60	V
Maximum Forward Voltage at 3.0A DC	0.75	0.875	0.90	V
Maximum Average DC Reverse Current at Rated Reverse Voltage T _A =25 °C	0.5			mA
T _A =100 °C	10			mA
Typical Junction capacitance (Note 1)	110			pF
Typical Thermal Resistance(Note 2)	80			°C/W
Operating and Storage Temperature Range	-50 to +125			°C

NOTES:

1. Measured at 1 MHz and applied reverse voltage of 4.0 VDC
2. Thermal Resistance Junction to Ambient

SCHOTTKY BARRIER DIODE

Typical Characteristics

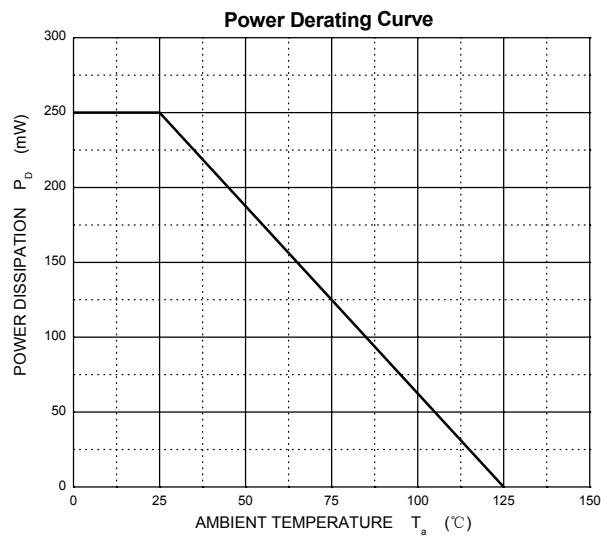
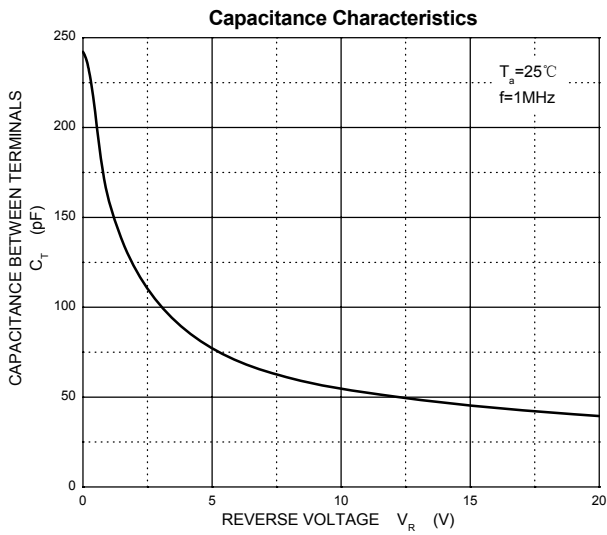
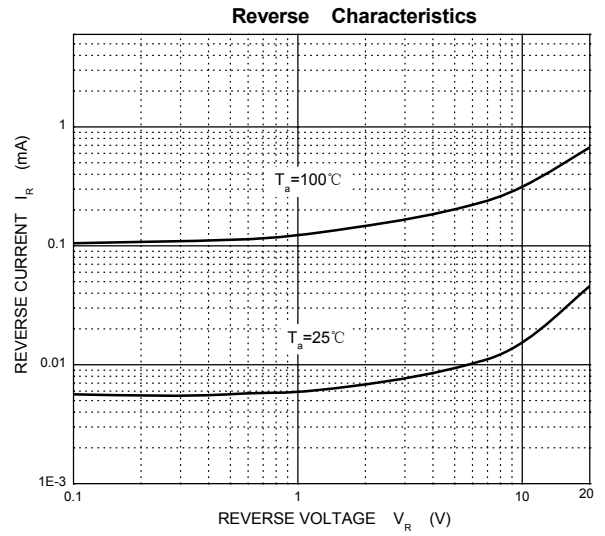
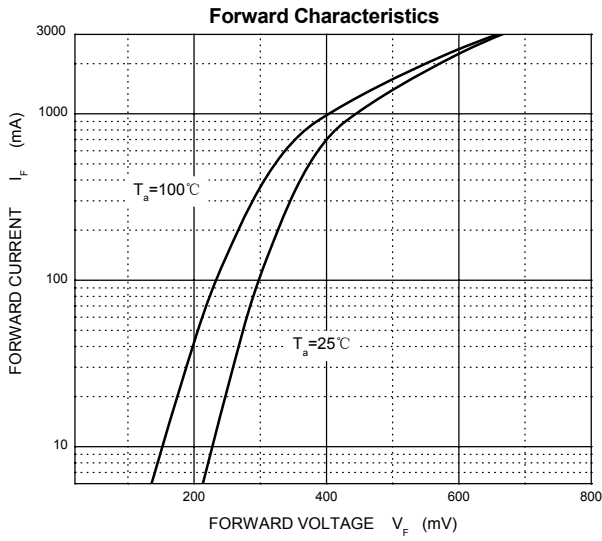

SCHOTTKY BARRIER DIODE

SOD-323 Package Outline Dimensions

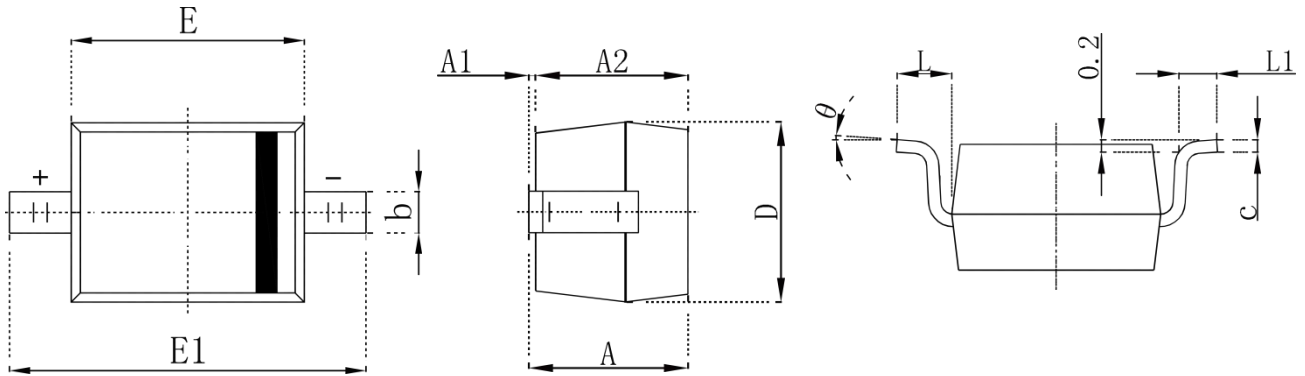

Symbol	Dimensions In Millimeters		Dimensions In Inches	
	Min.	Max.	Min.	Max.
A		1.000		0.039
A1	0.000	0.100	0.000	0.004
A2	0.800	0.900	0.031	0.035
b	0.250	0.350	0.010	0.014
c	0.080	0.150	0.003	0.006
D	1.200	1.400	0.047	0.055
E	1.600	1.800	0.063	0.071
E1	2.250	2.750	0.100	0.108
L	0.475 REF		0.019 REF	
L1	0.250	0.400	0.010	0.016
θ	0°	8°	0°	8°

SOD-323 Suggested Pad Layout

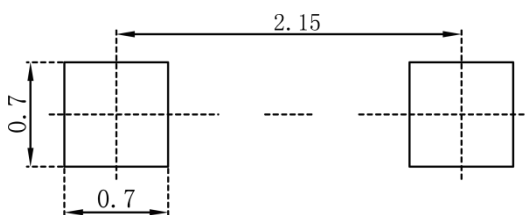

Note:

1. Controlling dimension: in millimeters
2. General tolerance: $\pm 0.05\text{mm}$
3. The pad layout is for reference purposes only

SCHOTTKY BARRIER DIODE

SOD-323 Tape and Reel

SOD-323 Embossed Carrier Tape

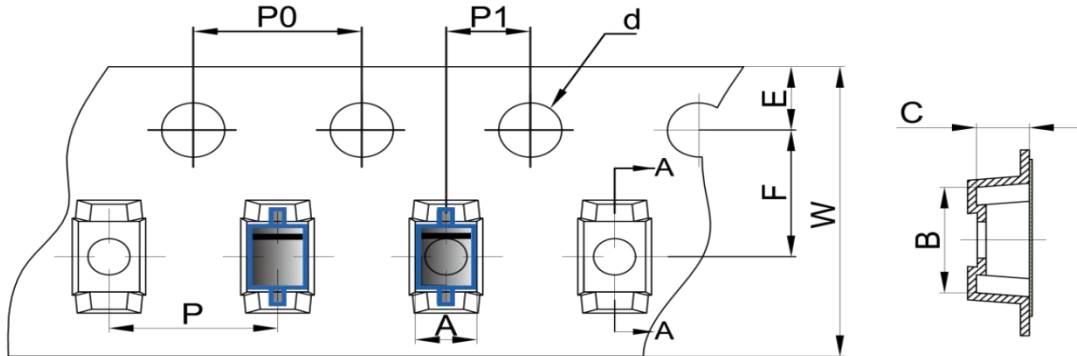

DIMENSIONS ARE IN MILLIMETER										
TYPE	A	B	C	d	E	F	P0	P	P1	W
SOD-323	1.48	3.3	1.25	Ø1.50	1.75	3.50	4.00	4.00	2.00	8.00
TOLERANCE	±0.1	±0.1	±0.1	±0.1	±0.1	±0.1	±0.1	±0.1	±0.1	±0.1

SOD-323 Tape Leader and Trailer

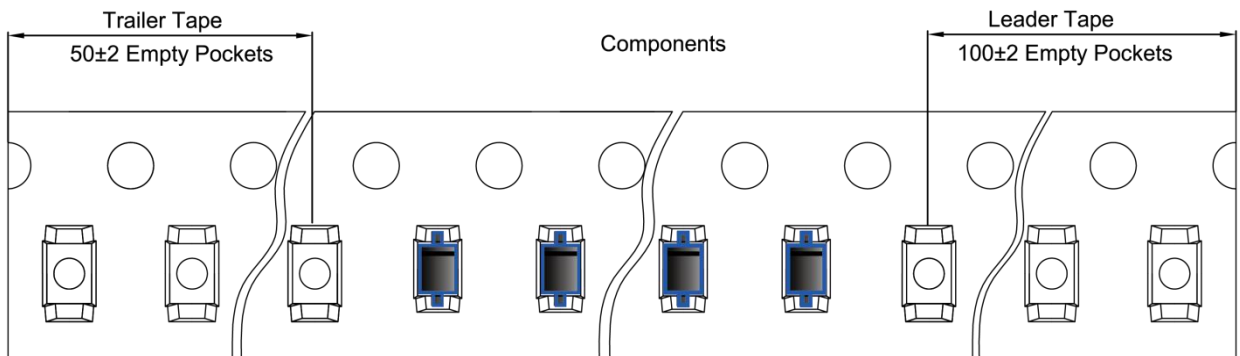

SOD-323 Reel

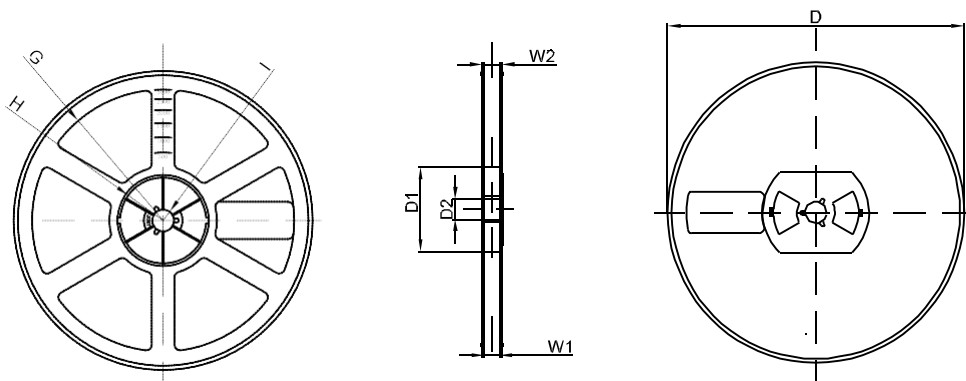

DIMENSIONS ARE IN MILLIMETER								
REEL OPTION	D	D1	D2	G	H	I	W1	W2
7" DIA	Ø178	54.40	13.00	R78	R25.60	R6.50	9.50	12.30
TOLERANCE	±2	±1	±1	±1	±1	±1	±1	±1