

## DTCxxxxCA-HF Series

RoHS Device  
Halogen Free

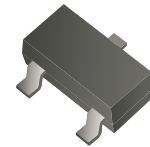

### Features

- Epitaxial planar die construction.
- Built-in biasing resistors,  $R_1 \neq R_2$ .

### Mechanical data

- Case: SOT-23, molded plastic.

### Circuit Diagram

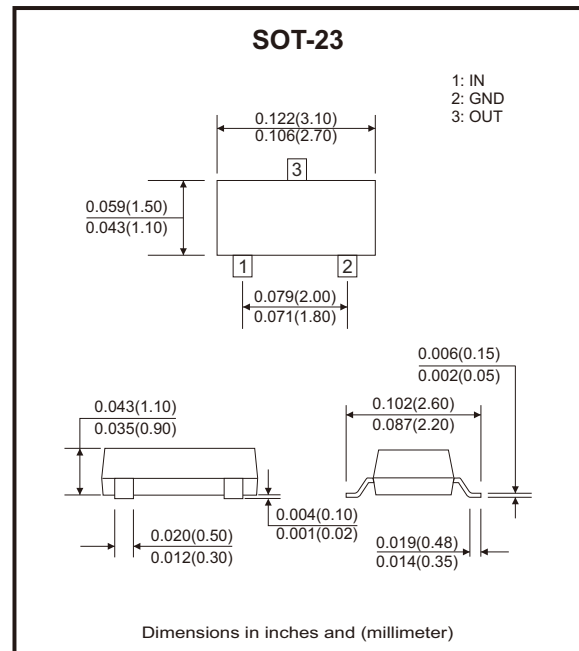
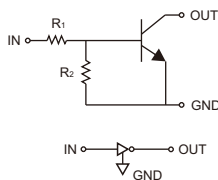

### Maximum Ratings (at $T_a=25^\circ\text{C}$ unless otherwise noted)

Parameter	Symbol	Value	Units
Supply voltage	$V_{CC}$	50	V
Input voltage	$V_{IN}$	-5 to +10 -10 to +30 -6 to +40 -5 to +12 -5 to +12 -7 to +20 -5 to +30	V
Output current	$I_o$	100 100 70 100 100 100 100	mA
Output current	$I_c$ (Max.)	100	mA
Power dissipation	$P_b$	200	mW
Thermal resistance, junction to ambient air	$R_{\theta JA}$	625	$^\circ\text{C}/\text{W}$
Operating and storage and temperature range	$T_j, T_{STG}$	-55 to +150	$^\circ\text{C}$

## Electrical Characteristics (at Ta=25°C unless otherwise noted)

Parameter	Symbol	Test conditions	Min	Typ	Max	Units
Input voltage	DTC113ZCA-HF DTC114WCA-HF DTC114YCA-HF DTC123JCA-HF DTC123YCA-HF DTC143XCA-HF DTC143ZCA-HF	$V_{I(off)}$ $V_{CC} = 5V, I_o = 100\mu A$	0.3			V
			0.8			
			0.3			
			0.5			
			0.3			
			0.3			
			0.5			
Input voltage	DTC113ZCA-HF DTC114WCA-HF DTC114YCA-HF DTC123JCA-HF DTC123YCA-HF DTC143XCA-HF DTC143ZCA-HF	$V_{I(on)}$ $V_o = 0.3V, I_o = 20mA$ $V_o = 0.3V, I_o = 2mA$ $V_o = 0.3V, I_o = 1mA$ $V_o = 0.3V, I_o = 5mA$ $V_o = 0.3V, I_o = 20mA$ $V_o = 0.3V, I_o = 20mA$ $V_o = 0.3V, I_o = 5mA$			3.0	V
					3.0	
					1.4	
					1.1	
					3.0	
					2.5	
					1.3	
Output voltage	DTC123JCA-HF DTC143ZCA-HF DTC114YCA-HF All others	$V_{O(on)}$ $I_o / I_i = 5mA / 0.25mA$		0.1	0.3	V
			$I_o / I_i = 10mA / 0.5mA$			
Input current	DTC113ZCA-HF DTC114WCA-HF DTC114YCA-HF DTC123JCA-HF DTC123YCA-HF DTC143XCA-HF DTC143ZCA-HF	$I_i$ $V_i = 5V$			7.2	mA
					0.88	
					0.88	
					3.6	
					3.8	
					1.8	
					1.8	
Output current	$I_{O(off)}$	$V_{CC} = 50V, V_i = 0V$			0.5	$\mu A$
DC current gain	DTC113ZCA-HF DTC114WCA-HF DTC114YCA-HF DTC123JCA-HF DTC123YCA-HF DTC143XCA-HF DTC143ZCA-HF	$G_I$ $V_o = 5V, I_o = 10mA$	33			
			24			
			68			
			80			
			33			
			30			
			80			
Input resistor	DTC113ZCA-HF DTC114WCA-HF DTC114YCA-HF DTC123JCA-HF DTC123YCA-HF DTC143XCA-HF DTC143ZCA-HF	$R_1(R_2)$	0.7	1(10)	1.3	k $\Omega$
			7	10(4.7)	13	
			7	10(47)	13	
			1.54	2.2(47)	2.86	
			1.54	2.2(10)	2.86	
			3.29	4.7(10)	6.11	
			3.29	4.7(47)	6.11	
Input resistor ( $R_1$ ) tolerance	$\Delta R_1$		-30		+30	%
Resistance ratio tolerance	$\Delta R_2/R_1$		-20		+20	%
Gain-bandwidth product	$f_r$	$V_{CE} = 10V, I_E = 5mA, f = 100MHz$		250		MHz

## Rating and Characteristic Curves (DTCxxxxCA-HF Series)

Fig.1 - Derating Curve

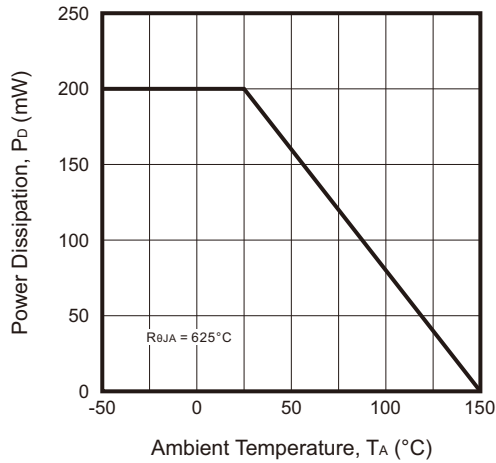

Fig.2 -  $V_{CE(SAT)}$  vs.  $I_c$

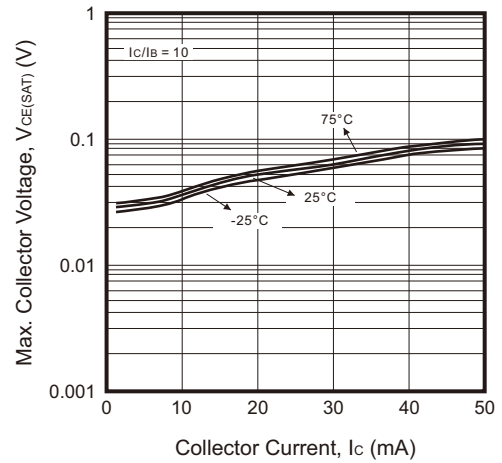

Fig.3 - DC Current Gain

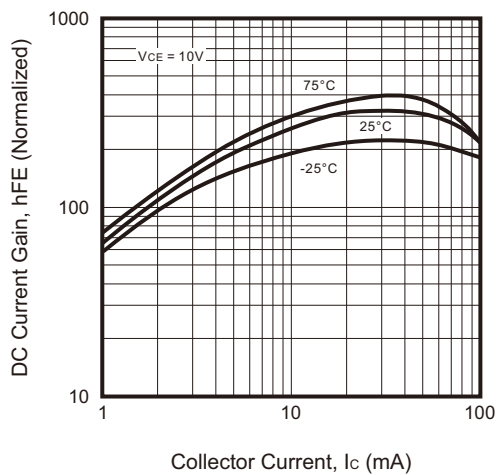

Fig.4 - Output Capacitance

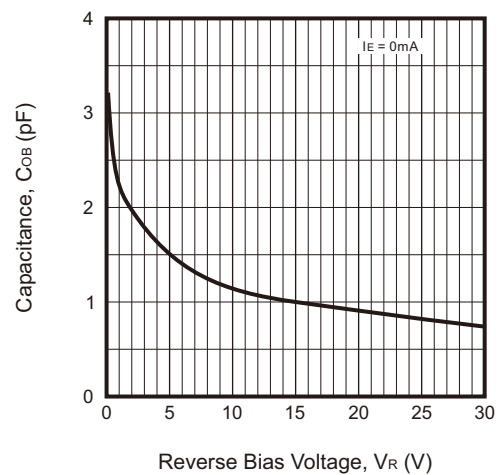

Fig.5 - Collector Current vs. Input Voltage

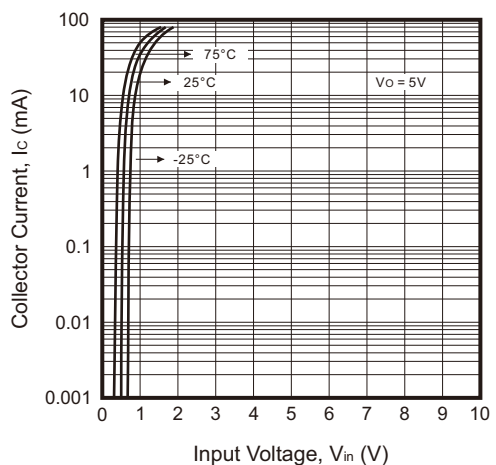
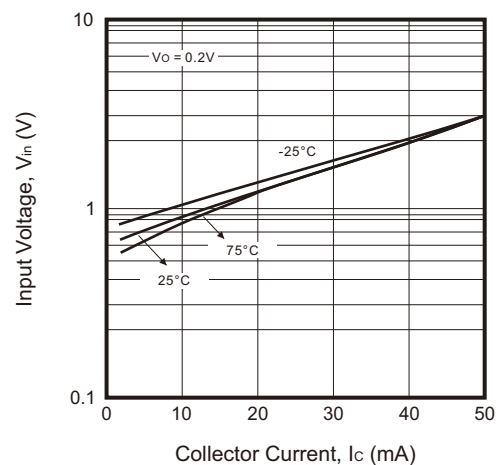
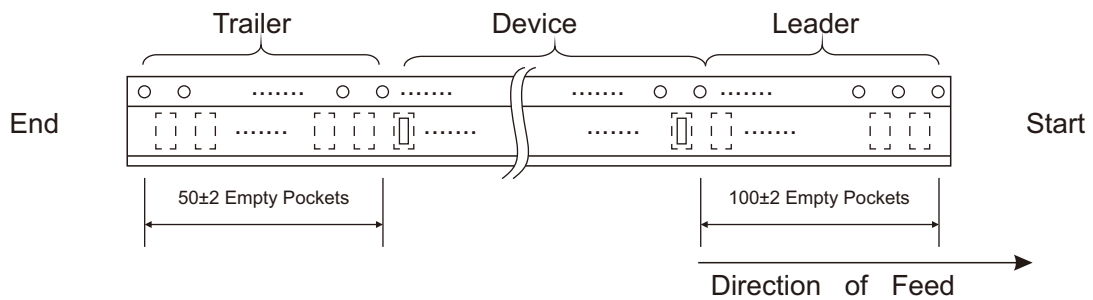
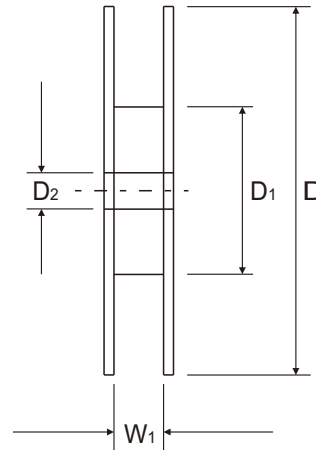
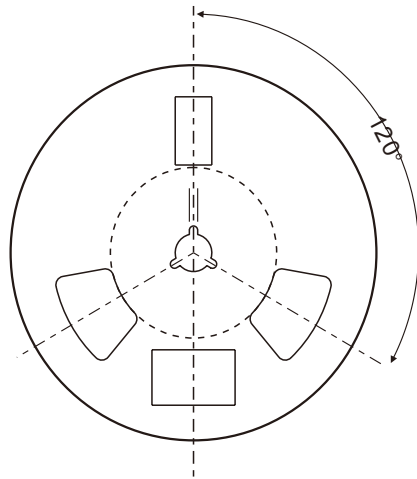
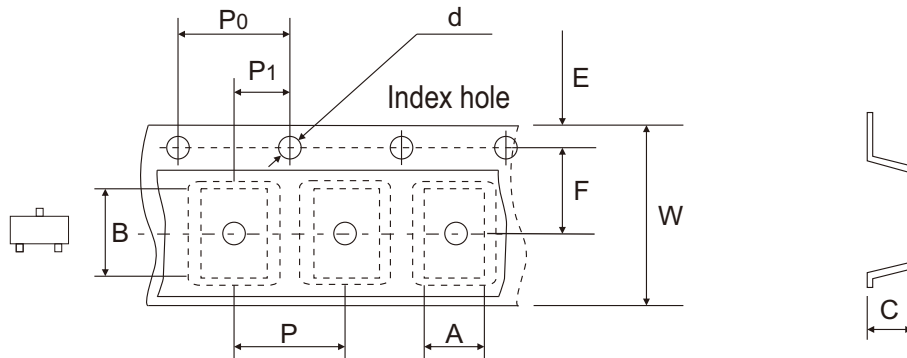

Fig.6 - Input Voltage vs. Collector Current



Company reserves the right to improve product design, functions and reliability without notice.

## Reel Taping Specification



SOT-23	SYMBOL	A	B	C	d	D	D1	D2
	(mm)	$3.15 \pm 0.10$	$2.77 \pm 0.10$	$1.22 \pm 0.10$	$1.50 \pm 0.10$	$178.00 \pm 1.00$	$54.00 \pm 0.50$	$13.00 \pm 0.50$
	(inch)	$0.124 \pm 0.004$	$0.109 \pm 0.004$	$0.048 \pm 0.004$	$0.059 \pm 0.004$	$7.008 \pm 0.039$	$2.126 \pm 0.020$	$0.512 \pm 0.020$

SOT-23	SYMBOL	E	F	P	P0	P1	W	W1
	(mm)	$1.75 \pm 0.10$	$3.50 \pm 0.05$	$4.00 \pm 0.10$	$4.00 \pm 0.10$	$2.00 \pm 0.05$	$8.00 + 0.30 - 0.10$	$9.50 \pm 1.00$
	(inch)	$0.069 \pm 0.004$	$0.138 \pm 0.002$	$0.157 \pm 0.004$	$0.157 \pm 0.004$	$0.079 \pm 0.002$	$0.315 + 0.012 - 0.004$	$0.374 \pm 0.039$

Company reserves the right to improve product design, functions and reliability without notice.

REV:A

## Marking Code

Part Number	Marking Code
DTC113ZCA-HF	E21
DTC114WCA-HF	84
DTC114YCA-HF	64
DTC123JCA-HF	E42
DTC123YCA-HF	62
DTC143XCA-HF	43•
DTC143ZCA-HF	E23

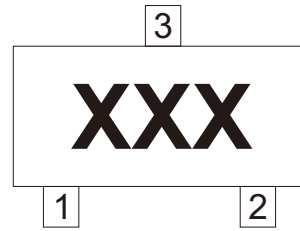

xx/xxx = Product type marking code

## Suggested PAD Layout

SIZE	SOT-23	
	(mm)	(inch)
A	0.90	0.035
B	0.80	0.031
C	0.95	0.037
D	2.00	0.079
E	2.90	0.114

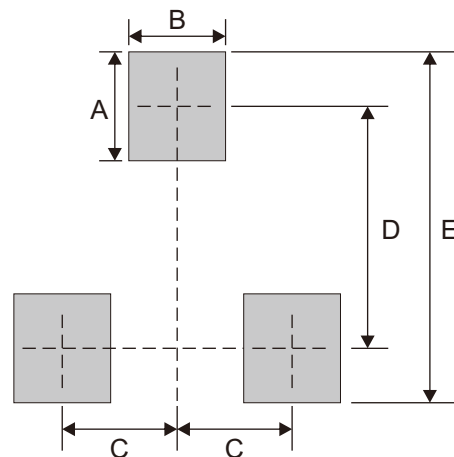

Note: 1. The pad layout is for reference purposes only.

## Standard Packaging

Case Type	REEL PACK	
	REEL (pcs)	Reel Size (inch)
SOT-23	3,000	7