

REV.	ECN. NO.	APPD.

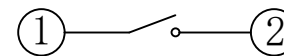

CIRCUIT DIAGRAM

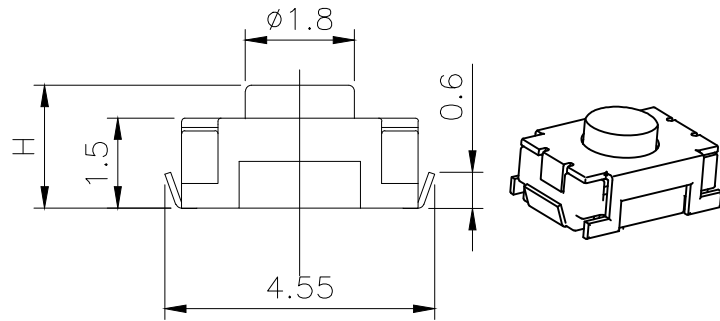
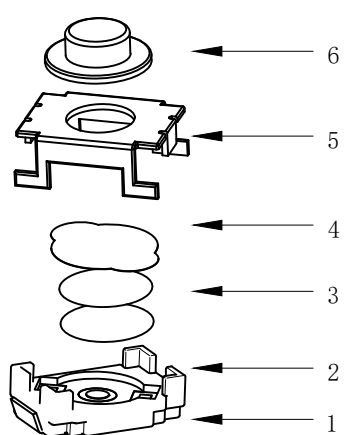
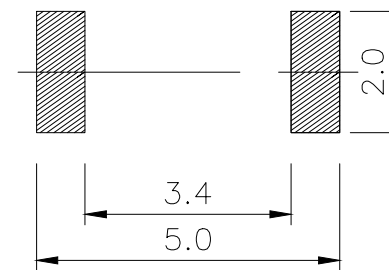
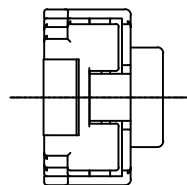
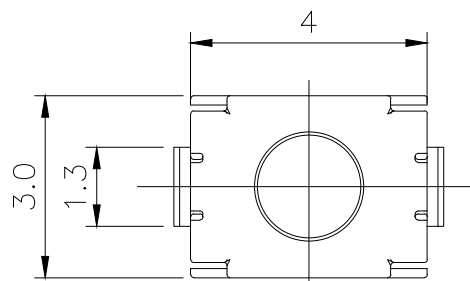

PCB. WELDING DRAWING

Specification

Operating Life	100,000
Contact rating	50mA@12V DC.
Insulation resistance	1011Ω min.
Contact resistance	100mΩ max. initial.
Dielectric Strength	250 V AC(1mm)
Travel	0.2±0.15mm
Storage Temperature	-30° C to 80° C

ITEM	DESCRIPTION	MATERIAL	QTY	FINISH/COLOR
E	Button	LCP/Silica	1	Black/Blue
D	COVER	Stainless Steel	1	Cleaning
C	DOME	Stainless Steel	1	Plated Ag
B	HOUSING	PPA	1	Black
A	PIN	PHOSPHOR BRONZE	1	Plated Ag

Mechanical

Type	Operating Force(gf)	Height mm	Button	Leads Shape(G, J, T)	Ground pin (0, 1)	Pegs Option(0, 1)		
YTS1T010	2	250±50	B	2.0	U(Blue) B(Black)	J	0 (None)	0 (None)
	1	180±50	A	1.8				

X. ±0.50	X. ° ±2°	UNITS mm
.X ±0.30	.X° ±1°	
.XX ±0.10	.XX° ±0.5°	MAT'L
.XXX ±0.05		FINISH
THESE DRAWINGS AND SPECIFICATIONS ARE THE PROPERTY OF YIYUAN TECHNOLOGY CO.,LTD AND SHALL NOT BE REPRODUCED, COPIED OR USED IN ANY MANNER WITHOUT THE PRIOR WRITTEN CONSENT OF YIYUAN TECHNOLOGY CO.,LTD		Q' TY



深圳市怡远科技有限公司
SHENZHEN YIYUAN TECHNOLOGY CO., LTD

PART NO.
YTS1T010

TITLE:
TACTILE SWITCH

APPD: ROGER

DWG NO.:
YTS1T010

CHKD: ROC

DR: BILLY WANG 2020/08/21

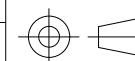

SCALE	SHEET	REV.
1/1	1/1	A1

Packaging:
Reel of 4,000 pieces.