

LEFT SIDE VIEW

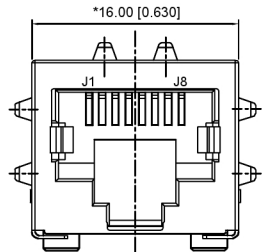

FRONT VIEW

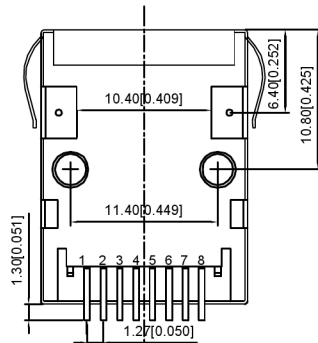

BOTTOM VIEW

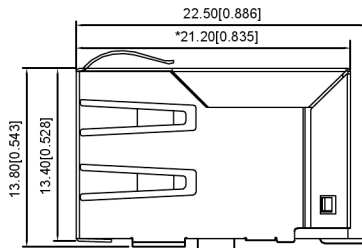

RIGHT SIDE VIEW

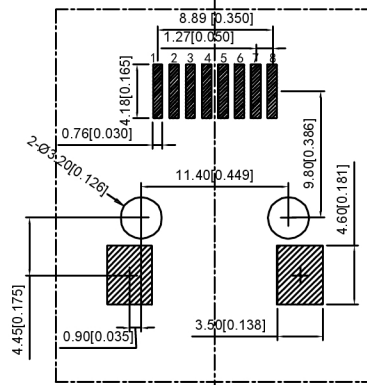

RECOMMENDED PCB LAYOUT  
VIEWED FROM COMPONENT SIDE

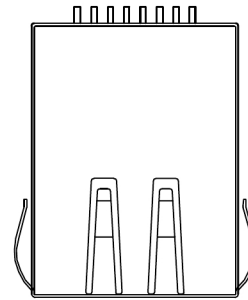

TOP VIEW

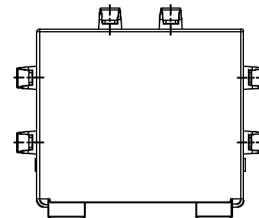

BACK VIEW

ELECTRICAL 电气:

- Turn ratio 匝数比: 1~2: J1~J2=1CT:1CT(±2%)  
3~6: J3~J6=1CT:1CT(±2%)
- OCL 已占搭载量: 350uH Min.at 100KHz 100mV 8mA DC.
- Insertion Loss 插入损耗: -1.0 dB Max 1~100MHz
- Return loss 回程损耗: -20dB Min 1~10MHz  
-16dB Min 10~30MHz  
-12dB Min 30~60MHz  
-10dB Min 60~80MHz
- Cross talk 声道串扰: -40dB Min 1~30MHz;  
-35dB Min 30~60MHz;  
-30dB Min 60~100MHz;
- CMR 共模抑制: -30dB Min 1~100MHz;
- Hi-Pot 耐压测试: 1500V AC & 2250V DC 6S  
1mA PRI TO SEC

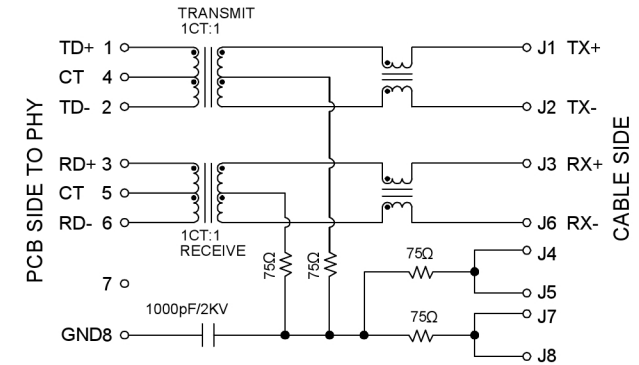

XKB Connectivity

MATERIAL 材料:

- HOUSING 外壳: LCP,UL94V-0,BLACK.
- TERMINALS BRACKET 端子支架: LCP,UL94V-0,BLACK.
- SHIELD 保护物: C2680,T=0.20MM,NICKEL PLATING ON ALL AREA.
- TERMINAL 端子: PHOSPHOR BRONZE C5210,T=0.35MM,  
GOLD PLATING ON CONTACT AREA.

MECHANICAL 机械:

- DURABILITY 耐用性: 750 CYCLES MIN.
- MATING FORCE 配合力: 30N MAX.
- OPERATING TEMPERATURE 工作温度: -40°C~+85°C.
- STORAGE TEMPERATURE 储存温度: -40°C~+85°C.
- ALL CRITICAL DIMENSIONS WITH ""

广东星坤科技股份有限公司

△X		日期
△X		日期
△X		日期
MARK		DESCRIPTION

文件工程章

REVISIONS	DATE	REVISED	APPROVED	DESCRIPTION
ANGLAR				
L ≤ 4				±5°
4 < L ≤ 16				±0.2
16 < L ≤ 63				±0.3
L > 63				±0.4
UNSPECIFIED TOLERANCES				



XKB INDUSTRIAL PRECISION CO.,LIMITED

DSND		SCALE: N/A	MODEL TYPE: RJ JACK
DWN		VIEW:	PART NO.:
CHKD		UNIT: mm/in	DWG NO.:
APPD		SIZE: A4	X01AB002HWGS
		WEIGHT	SHEET
		1/1	REVISIO
			A0