

承 認 書

SPECIFICATION FOR APPROVAL

Customer Name: 2144

Description Part No.: _____

Customer Part No.: _____

Sample No.: _____

DDY Part No.: SFE3015A-

DRAWING		
MADE	CHECKED	APPROVED
王海玲	赵万虎	肖中华
DATE: 2022年8月23日		

CUSTOMER APPROVE



惠 州 市 德 立 电 子 有 限 公 司

HUI ZHOU DE LI ELECTRONICS CO., LTD

廣 東 省 博 羅 縣 洲 際 工 業 園 梅 園 三 路

NO.3 MEI YUAN ROAD,ZHOU JI INDUSTRIAL AREA,BOLUO COUNTY GUANGDONG

電話：0752-6207968 0752-6207962

傳真：0752-6207969

郵編：516100

Http: www.ddycoils.com



惠州市德立电子有限公司

HUI ZHOU DE LI ELECTRONICS CO., LTD

Version of Changed Record

DATE	REV	CHANGED CONTENTS	DRAFT	APPROVED
2022/8/23	A	新版发行	王海玲	肖中华

*** Special notes:**
 This material does not involve the application of automobile or related products, otherwise, we will not bear all the quality and responsibility problems caused by this.



1. Scope

This specification applies to the SFE3015 Series of wire wound SMD power inductor.

2.PRODUCT IDENTIFICATION

SFE 3015 □ - 1R5 □ - □ - □

(1) (2) (3) (4) (5) (6) (7)

- (1) .Series name (产品品名)
- (2) .Dimensions (产品尺寸)
- (3) .Appearance shape (产品形状)
A: dodecagon (十二边形) ; B: octagon (八边形)
- (4) .Inductance value (电感值)
1R5: 1.5μH 221: 220μH
- (5) Tolerance (误差值)
M: ±20%; N: ±30%
- (6) .Packaging style (包装类型)
T-编带盘装; B-散装
- (7) .Environmental status (环保状态)
LF- Lead free; HF-Halogen free; FP-Free red phosphor.

3. Electrical Characteristics

Please refer to Item 5.

- 1). Operating temperature range (individual chip without packing): -40°C ~ +125°C .
- 2). Storage temperature range (packaging conditions): -40°C ~ +85°C and RH 70% (Max.).
- 3). Rating DC current: Temperature rise(ΔT) is 40°C approximately at Irms.
- 4). Saturation DC current: Inductance drop approximately 30% of L₀ at Isat.

4. Shape and Dimensions (Unit:mm)

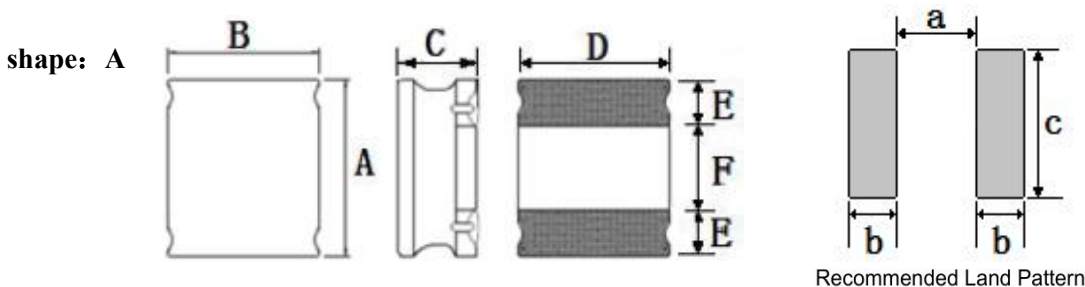

Series	A	B	C	D	E	F	a Typ.	b Typ.	c Typ.
SFE3015A	3.0±0.2	3.0±0.2	1.5 Max.	2.5±0.2	0.9 Typ.	1.2 Typ.	1.00	1.10	2.7



5. Electrical Characteristics

NO.	Part Number	Inductance		DC Resistance		Isat(A)		Irms(A)		Marking
		100KHz/1.0V		Max.	Typ.	Max.	Typ.	Max.	Typ.	
	Units	(uH)	Ω	Ω	A	A	A	A		
1	<input type="checkbox"/> SFE3015A-1R5N-F-HF	1.5±30%	0.065	0.050	2.30	2.70	1.70	2.20	1R5	
2	<input type="checkbox"/> SFE3015A-2R2M-F-HF	2.2±20%	0.078	0.064	1.60	2.00	1.60	2.00	2R2	
3	<input type="checkbox"/> SFE3015A-4R7M-F-HF	4.7±20%	0.163	0.108	1.10	1.30	1.10	1.20	4R7	
4	<input type="checkbox"/> SFE3015A-100M-F-HF	10.0±20%	0.325	0.270	0.77	0.92	0.77	0.80	100	

*Design as Customer's Requested Specifications. (可按顾客的特殊需求设计)



6. Structure (The structure of product.)

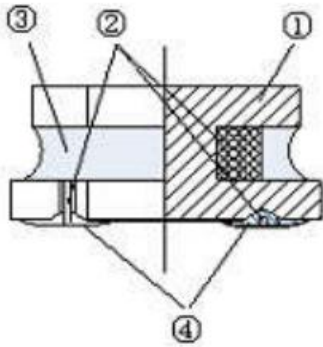

NO	Components	Material
①	Core	Ni-Zn Ferrite
②	Wire	Polyurethane system enameled copper wire
③	Magnetic Glue	Epoxy resin and magnetic powder
④	Plating	AgNiSn or FeNiCu + Sn Alloy

7. PACKAGING(unit: mm)

1.包装类型：编带装

2.包装尺寸：

13" 盘

7" 盘

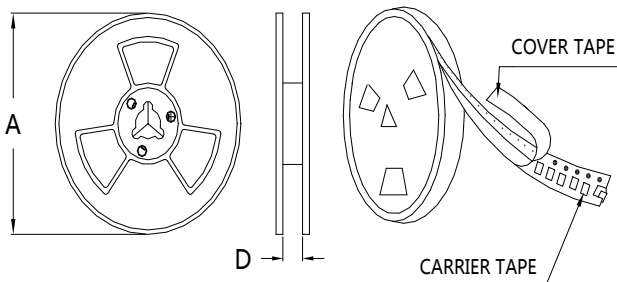

	13" 盘	7" 盘
A	$\Phi 330 \pm 2.0$	$\Phi 178 \pm 2.0$
D	8.5	

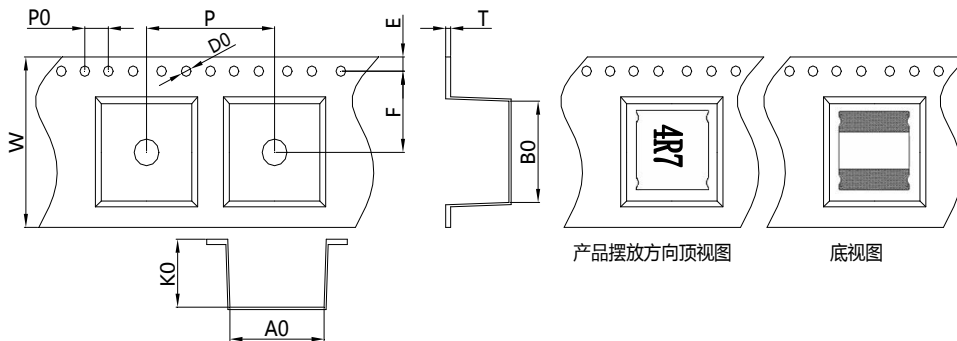

Item	W	A0	B0	K0	P	T	E	F	D0	P0
(mm)	8.0 ± 0.3	3.3 ± 0.15	3.3 ± 0.15	2.0 ± 0.1	4.0 ± 0.1	0.3 ± 0.1	1.75 ± 0.1	3.5 ± 0.1	1.5 ± 0.1	4.0 ± 0.1

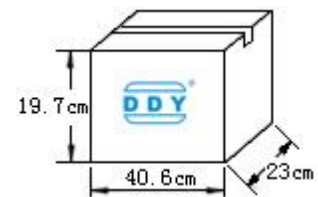
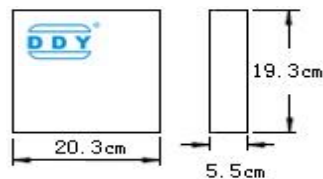

每卷 2000 Pcs

每盒 4卷,共 8000 Pcs

每箱 6盒,共 48000 Pcs

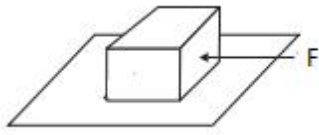

8. RELIABILITY TEST			
No.	TEST ITEM	SPECIFICATION	TEST CONDITION
1	High temperature Storage test	1. No significant defects in appearance. 2. $\Delta L/L \leq 10\%$ 3. $\Delta DCR/DCR \leq 10\%$	Temperature: $125^{\circ}\text{C} \pm 5^{\circ}\text{C}$ (N: Follow the product specification for the setting.) Time : 96 ± 2 hours Place the samples for one hour at room temperature and test them within two hours
2	Low temperature Storage test	1. No significant defects in appearance. 2. $\Delta L/L \leq 10\%$ 3. $\Delta DCR/DCR \leq 10\%$	Temperature: $-40^{\circ}\text{C} \pm 5^{\circ}\text{C}$ (M: Follow the product specification for the setting) Time : 96 ± 2 hours Place the samples for one hour at room temperature and test them within two hours.
3	Humidity test	1. No significant defects in appearance. 2. $\Delta L/L \leq 10\%$ 3. $\Delta DCR/DCR \leq 10\%$	Temperature: $40 \pm 2^{\circ}\text{C}$, Humidity: $93 \pm 3\% \text{RH}$ Time : 96 ± 2 hours Place the samples for one hour at room temperature and test them within two hours
4	Solderability test	Terminals must have 95% minimum solder coverage	1. Dip pads in flux then dip in solder pot at $245 \pm 5^{\circ}\text{C}$ for 5 second. 2. Solder: lead free 3. Flux: rosin flux
5	Heat endurance of flow soldering	1. No significant defects in appearance. 2. $\Delta L/L \leq 10\%$ 3. $\Delta DCR/DCR \leq 10\%$	1. Refer to the above reflow curve and go through the reflow for twice. 2. The peak temperature : $260 + 0 / - 5^{\circ}\text{C}$
6	Vibration test	1. No significant defects in appearance. 2. No short and no open.	Apply frequency 10~55~10Hz and amplitude 1.5mm, 1 min/cycle in X Y and Z direction for 2 hours each. (total 6 hours)
7	Terminal strength push test	1. Applied force: 10N Duration: 10sec 2. Solder paste thickness: 0.12mm 3. Meet the above requirements without any loose termina	Solder the test samples to the PCB through 245°C reflow, apply a standard force on the side of the test samples for 10 seconds. 



9. SOLDERING CONDITIONS

Applicable soldering process to the products is refl.

9.1 Soldering Materials

(1) Solder: Sn-3.0Ag-0.5Cu

(2) Flux: Use rosin-based flux, but not strongly acidic flux (with chlorine exceeding 0.2wt%). Do not use water-soluble flux.

9.2 Reflow Soldering Profile

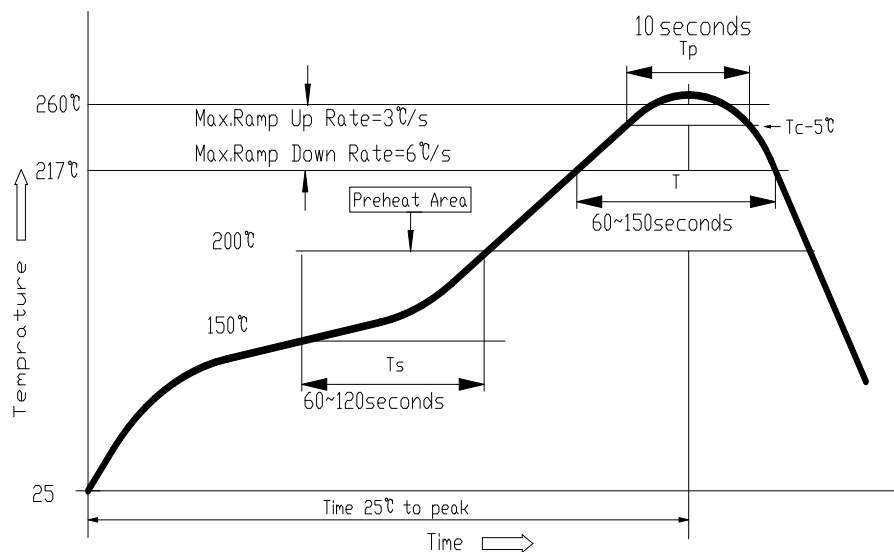

9.3 Soldering Iron

Reworking with electric soldering iron must preheating at 150°C for 1 minute is required, and do not directly touch the core with the tip of the soldering iron. The reworking soldering conditions are as follows.

- ① Temperature of soldering iron tip: 350°C;
- ② Soldering iron power output: $\leq 30W$;
- ③ Diameter of soldering iron end: $\leq 1.0mm$;
- ④ Soldering time: $< 3s$

