

承 認 書

SPECIFICATION FOR APPROVAL

Customer Name: 2144

Description Part No.: _____

Customer Part No.: _____

Sample No.: _____

DDY Part No.: SFE3015A-

DRAWING		
MADE	CHECKED	APPROVED
王海玲	赵万虎	肖中华
DATE: 2022年8月23日		

CUSTOMER APPROVE



惠 州 市 德 立 电 子 有 限 公 司

HUI ZHOU DE LI ELECTRONICS CO., LTD

廣 東 省 博 羅 縣 洲 際 工 業 園 梅 園 三 路

NO.3 MEI YUAN ROAD,ZHOU JI INDUSTRIAL AREA,BOLUO COUNTY GUANGDONG

電話：0752-6207968 0752-6207962

傳真：0752-6207969

郵編：516100

Http: www.ddycoils.com



1. Scope

This specification applies to the SFE3015 Series of wire wound SMD power inductor.

2.PRODUCT IDENTIFICATION

SFE 3015 □ - 1R5 □ - □ - □

(1) (2) (3) (4) (5) (6) (7)

- | | |
|---|--|
| (1) .Series name (产品品名) | (2) .Dimensions (产品尺寸) |
| (3) .Appearance shape (产品形状)
A: dodecagon (十二边形) : B: octagon (八边形) | (4) .Inductance value (电感值)
1R5: 1.5μH 221: 220μH |
| (5) Tolerance (误差值)
M: ±20%; N: ±30% | (6) .Packaging style (包装类型)
T-编带盘装; B-散装 |
| (7) .Environmental status (环保状态)
LF- Lead free; HF-Halogen free; FP-Free red phosphor. | |

3. Electrical Characteristics

Please refer to Item 5.

- Operating temperature range (individual chip without packing): -40°C ~ +125°C .
- Storage temperature range (packaging conditions): -40°C ~ +85°C and RH 70% (Max.).
- Rating DC current: Temperature rise(ΔT) is 40°C approximately at Irms.
- Saturation DC current: Inductance drop approximately 30% of L₀ at Isat.

4. Shape and Dimensions (Unit:mm)

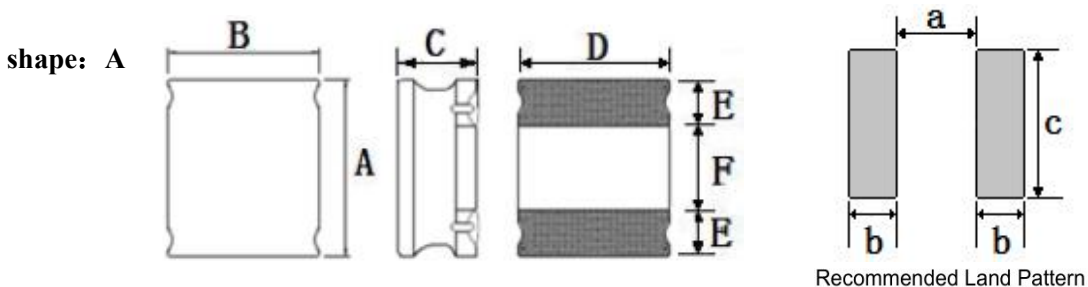

Series	A	B	C	D	E	F	a Typ.	b Typ.	c Typ.
SFE3015A	3.0±0.2	3.0±0.2	1.5 Max.	2.5±0.2	0.9 Typ.	1.2 Typ.	1.00	1.10	2.7



6. Structure (The structure of product.)

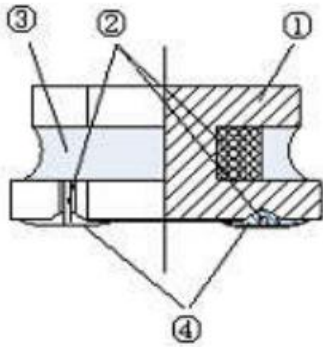

NO	Components	Material
①	Core	Ni-Zn Ferrite
②	Wire	Polyurethane system enameled copper wire
③	Magnetic Glue	Epoxy resin and magnetic powder
④	Plating	AgNiSn or FeNiCu + Sn Alloy

7. PACKAGING(unit: mm)

1.包装类型：编带装

2.包装尺寸：

13" 盘

7" 盘

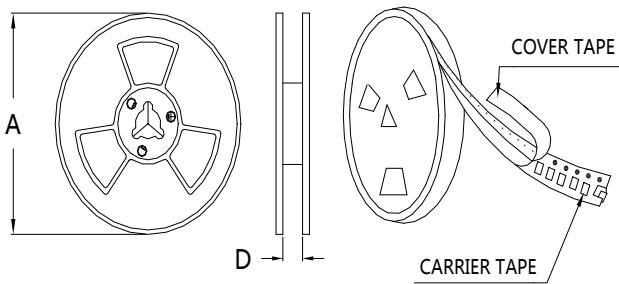

	13" 盘	7" 盘
A	$\Phi 330 \pm 2.0$	$\Phi 178 \pm 2.0$
D	8.5	

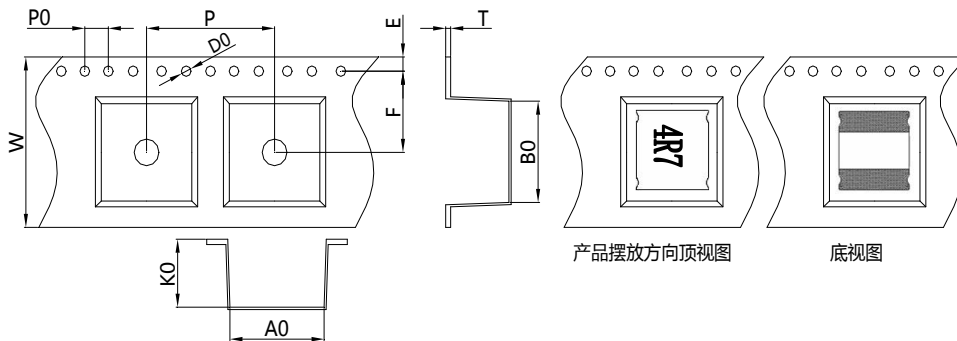

Item	W	A0	B0	K0	P	T	E	F	D0	P0
(mm)	8.0 ± 0.3	3.3 ± 0.15	3.3 ± 0.15	2.0 ± 0.1	4.0 ± 0.1	0.3 ± 0.1	1.75 ± 0.1	3.5 ± 0.1	1.5 ± 0.1	4.0 ± 0.1

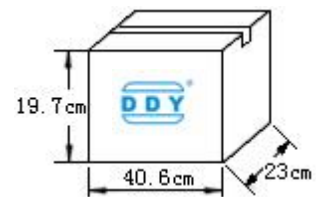
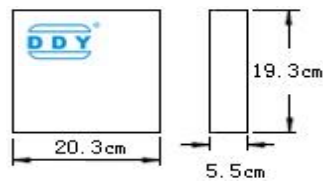

每卷 2000 Pcs

每盒 4卷,共 8000 Pcs

每箱 6盒,共 48000 Pcs

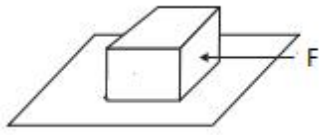

8. RELIABILITY TEST			
No.	TEST ITEM	SPECIFICATION	TEST CONDITION
1	High temperature Storage test	1. No significant defects in appearance. 2. $\Delta L/L \leq 10\%$ 3. $\Delta DCR/DCR \leq 10\%$	Temperature: $125^{\circ}\text{C} \pm 5^{\circ}\text{C}$ (N: Follow the product specification for the setting.) Time : 96 ± 2 hours Place the samples for one hour at room temperature and test them within two hours
2	Low temperature Storage test	1. No significant defects in appearance. 2. $\Delta L/L \leq 10\%$ 3. $\Delta DCR/DCR \leq 10\%$	Temperature: $-40^{\circ}\text{C} \pm 5^{\circ}\text{C}$ (M: Follow the product specification for the setting) Time : 96 ± 2 hours Place the samples for one hour at room temperature and test them within two hours.
3	Humidity test	1. No significant defects in appearance. 2. $\Delta L/L \leq 10\%$ 3. $\Delta DCR/DCR \leq 10\%$	Temperature: $40 \pm 2^{\circ}\text{C}$, Humidity: $93 \pm 3\% \text{RH}$ Time : 96 ± 2 hours Place the samples for one hour at room temperature and test them within two hours
4	Solderability test	Terminals must have 95% minimum solder coverage	1. Dip pads in flux then dip in solder pot at $245 \pm 5^{\circ}\text{C}$ for 5 second. 2. Solder: lead free 3. Flux: rosin flux
5	Heat endurance of flow soldering	1. No significant defects in appearance. 2. $\Delta L/L \leq 10\%$ 3. $\Delta DCR/DCR \leq 10\%$	1. Refer to the above reflow curve and go through the reflow for twice. 2. The peak temperature : $260 + 0 / - 5^{\circ}\text{C}$
6	Vibration test	1. No significant defects in appearance. 2. No short and no open.	Apply frequency 10~55~10Hz and amplitude 1.5mm, 1 min/cycle in X Y and Z direction for 2 hours each. (total 6 hours)
7	Terminal strength push test	1. Applied force: 10N Duration: 10sec 2. Solder paste thickness: 0.12mm 3. Meet the above requirements without any loose termina	Solder the test samples to the PCB through 245°C reflow, apply a standard force on the side of the test samples for 10 seconds. 



9. SOLDERING CONDITIONS

Applicable soldering process to the products is refl.

9.1 Soldering Materials

(1) Solder: Sn-3.0Ag-0.5Cu

(2) Flux: Use rosin-based flux, but not strongly acidic flux (with chlorine exceeding 0.2wt%). Do not use water-soluble flux.

9.2 Reflow Soldering Profile

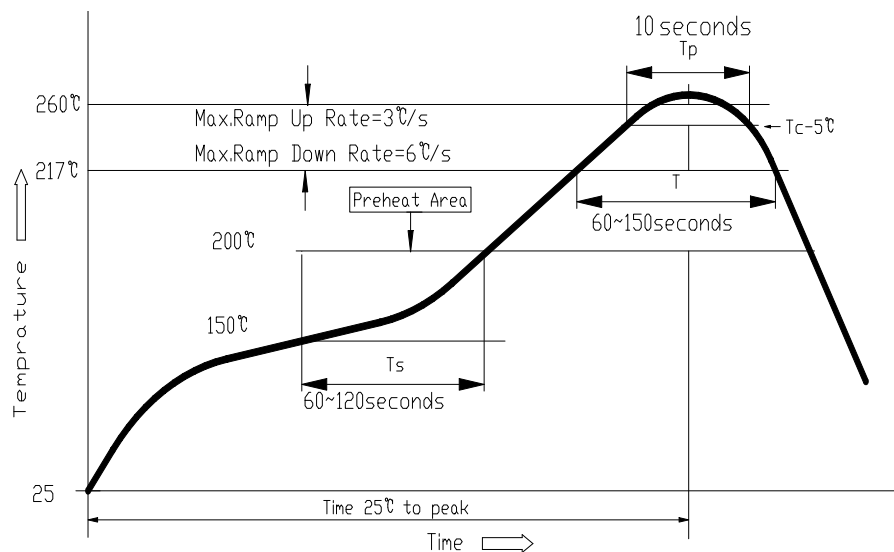

9.3 Soldering Iron

Reworking with electric soldering iron must preheating at 150°C for 1 minute is required, and do not directly touch the core with the tip of the soldering iron. The reworking soldering conditions are as follows.

- ① Temperature of soldering iron tip: 350°C;
- ② Soldering iron power output: $\leq 30\text{W}$;
- ③ Diameter of soldering iron end: $\leq 1.0\text{mm}$;
- ④ Soldering time: $< 3\text{ s}$

