

客户 (Customer) : _____

承认书

Approval Sheet

谨致执事者：兹提供敝公司之有关详细规格及图面数据，敬请给予办理试认定手续。
同时敬请送返一份附有贵公司签认之测试认定后之样品承认书。

We are pleased in sending you herewith on specification and drawings for your approval.
Please return to us one copy "Approval sheet" with your approved signature.

型号 (Model No.) : A-SL910W1D-A01-4T

发文日期 (Issue Date) : 2022/03/17 承认日期 (Approved Date) : _____

Checking signature of Amicc

Designer	Checker	Approver
Mars	<i>Tommy</i>	Solarliu

Approval signature of customer

Designer	Checker	Approver

江苏欧密格光电科技股份有限公司

Jiangsu Amicc Opto-Electronics Technology Co.,Ltd.

地址：江苏省常州市武进区武南中路 98 号

Add: 98.Wu Nan Road, Wujin, Changzhou city, Jiangsu Province

TEL:0086-519-89806973

FAX:0086-519-86523668

Mini power Type ■ Top View 1808 Package

A-SL910W1D-A01-4T



■ Description

The Amicc 910 package has high efficiency , low power consumption, wide viewing angle and a compact form. These features make this package to be an ideal LED for all lighting applications.

■ Features

- Top view LED
- High luminous Intensity output
- Wide viewing angle
- Pb-free
- RoHS compliant
- Compliance with EU REACH
- JEDEC MSL 3

■ Applications

- Backlighting in dashboard and switch
- Backlighting and Indicator light in Telecommunication equipment
- Flat backlight for LCD,switch and symbol
- General use

■ Device Selection Guide

Chip Materials	Emitted Color	Resin Color
InGaN	Nature White	Yellow Diffused

■ Package Dimensions

Top view

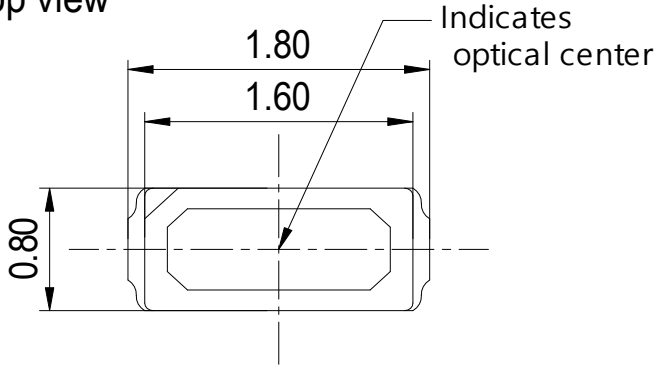

Side view

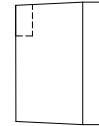

Side view

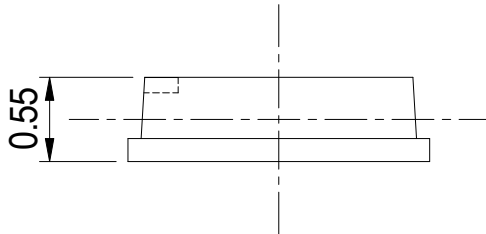

Polarity

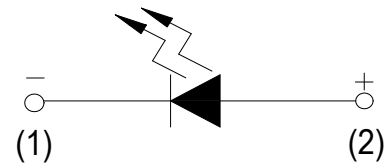

Bottom view

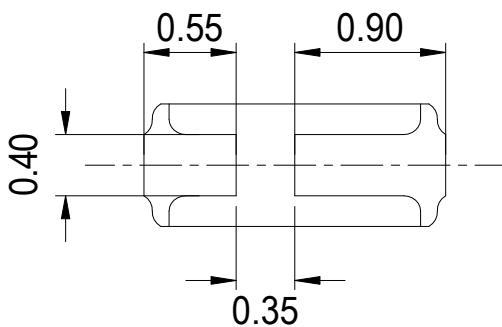

Recommend Sodering Pad

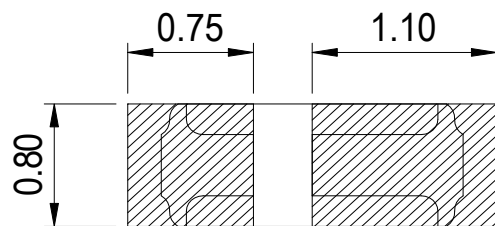

Notes:

1. Dimensions are in millimeters
2. Tolerance is unless mentioned $\pm 0.1\text{mm}$.

■ **Absolute Maximum Ratings (T_{Soldering}=25°C)**

Parameter	Symbol	Rating	Unit
Forward Current	I _F	20	mA
Surge Current (t≤10 us; D=0.005; T _s =25°C)	I _{FM}	300	mA
Power Dissipation	P _d	60	mW
Operating Temperature	T _{opr}	-40 ~ +85	°C
Storage Temperature	T _{stg}	-40 ~ +100	°C
Junction Temperature	T _j	115	°C
Soldering Temperature	T _{sol}	Reflow Soldering : 260 °C for 10 sec. Hand Soldering : 350 °C for 3 sec.	

■ **Electro-Optical Characteristics (T_{Soldering}=25°C)**

Parameter	Symbol	Min.	Typ.	Max.	Unit	Condition
Luminous Intensity	I _v	1500	2100	3000	mcd	I _F =20mA
Forward Voltage	V _F	2.6	3.0	3.4	V	I _F =20mA
Chromaticity Coordinates	CIE-X	-----	0.270	-----	-----	I _F =20mA
Chromaticity Coordinates	CIE-Y	-----	0.265	-----	-----	I _F =20mA
Viewing Angle	2θ _{1/2}	-----	120	-----	deg	I _F =20mA
Reverse Current	I _R	-----	-----	1	μA	V _R =7V

Notes:

1. Tolerance of Luminous Intensity: ±10%.
2. Tolerance of forward voltage: ±0.1V.

■ **Bin Range of Luminous Intensity**

Bin Code	Min.	Max.	Unit	Condition
L7	1500	1800	mcd	I _F =20mA
L8	1800	2500		
L9	2500	3000		

Notes:
Tolerance of Luminous Intensity: ±10%.

■ **Bin Range of Forward Voltage**

Bin Code	Min.	Max.	Unit	Condition
34	2.6	2.8	V	I _F =20mA
36	2.8	3.0		
38	3.0	3.2		
40	3.2	3.4		

Notes:
Tolerance of Forward Voltage: ±0.1V.

■ **Bin Range of Chromaticity Coordinates**

Bin Code	CIE_x	CIE_y	Bin Code	CIE_x	CIE_y
E	0.2525	0.2410	F	0.2575	0.2510
	0.2575	0.2510		0.2625	0.2610
	0.2675	0.2510		0.2725	0.2610
	0.2625	0.2410		0.2675	0.2510
G	0.2625	0.2610	H	0.2675	0.2710
	0.2675	0.2710		0.2725	0.2810
	0.2775	0.2710		0.2825	0.2810
	0.2725	0.2610		0.2775	0.2710
J	0.2725	0.2810			
	0.2775	0.2910			
	0.2875	0.2910			
	0.2825	0.2810			

■ The C.I.E. 1931 Chromaticity Diagram

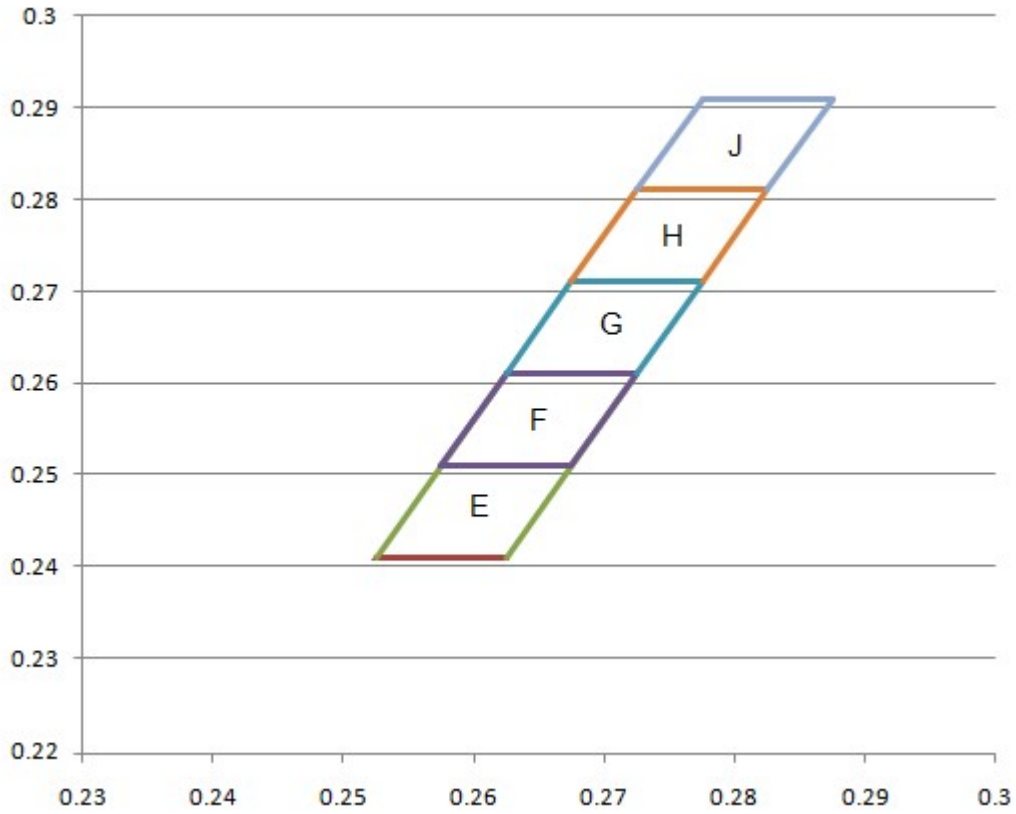

Notes:
Tolerance of Chromaticity Coordinates: ± 0.01 .

■ **Spectrum Distribution**

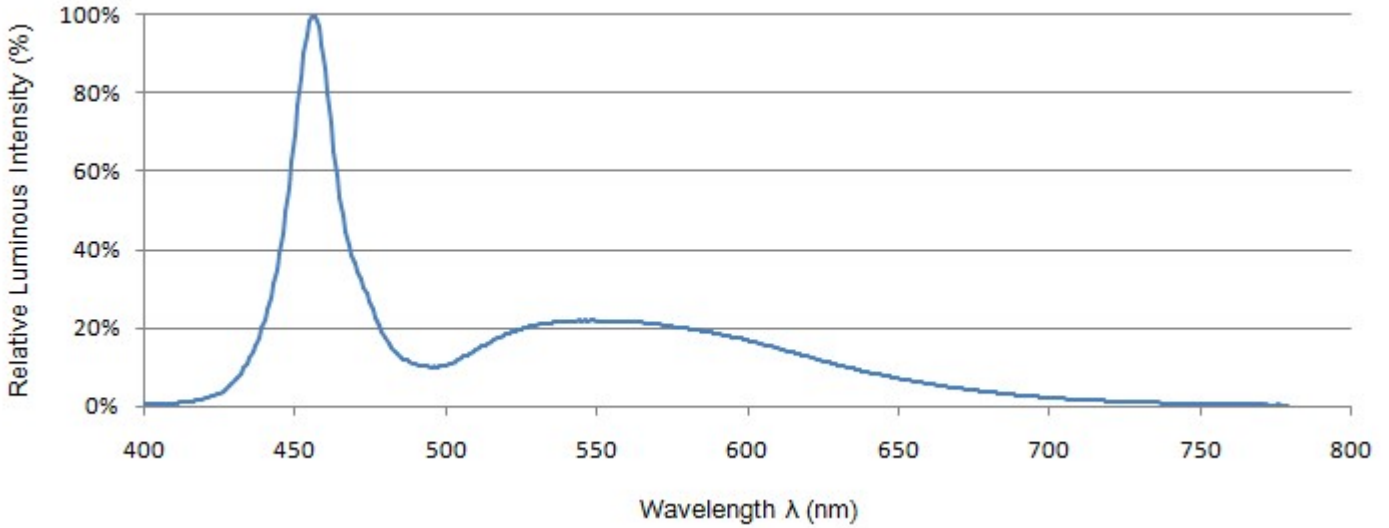

■ **Typical Electro-Optical Characteristics Curves**

Fig.1-Forward Voltage Shift vs. Junction Temperature

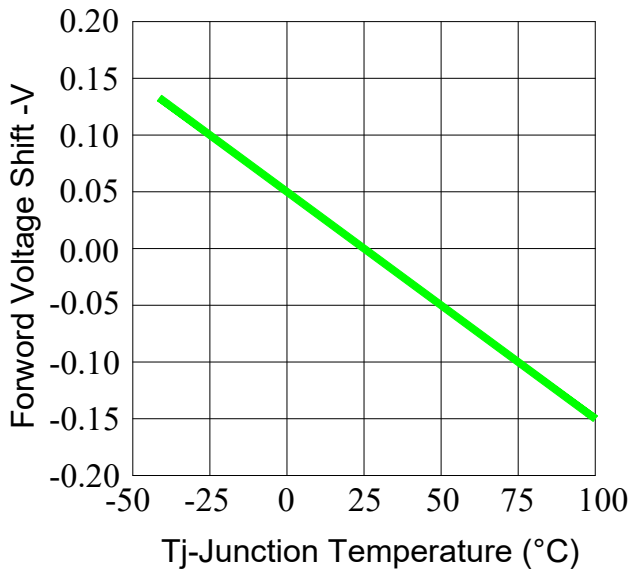
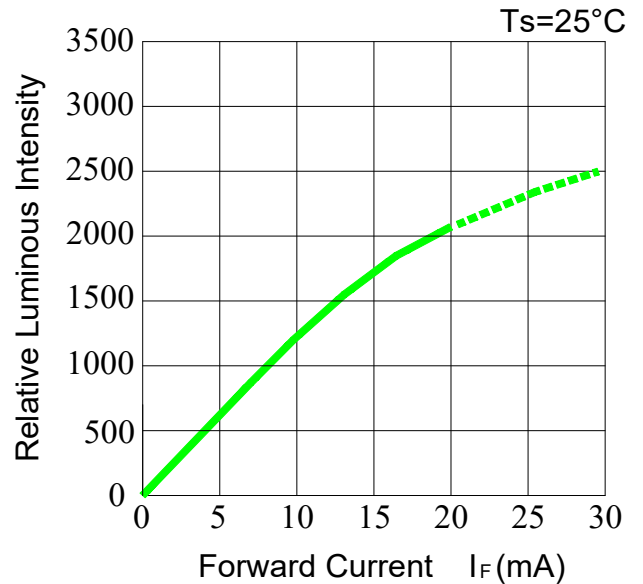

Fig.2-Relative Luminous Intensity vs. Forward Current



■ **Typical Electro-Optical Characteristics Curves**

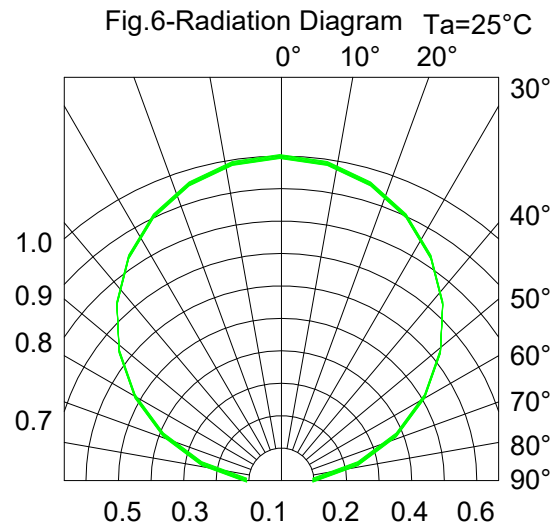
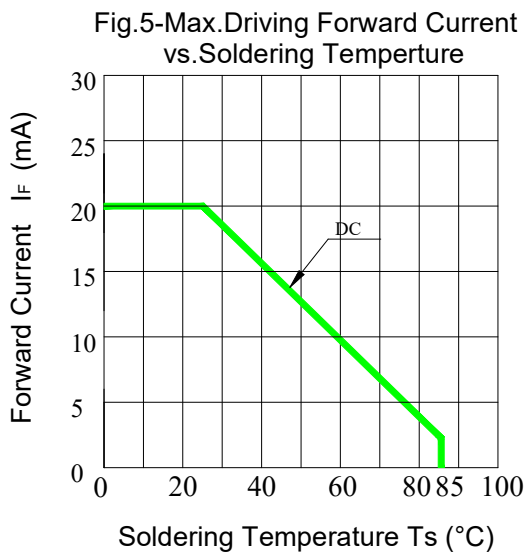
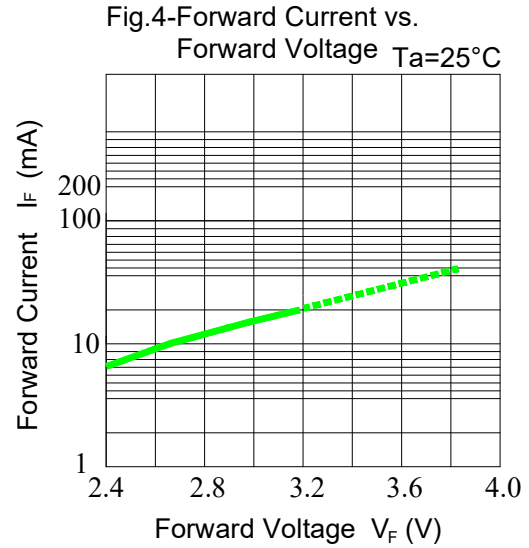
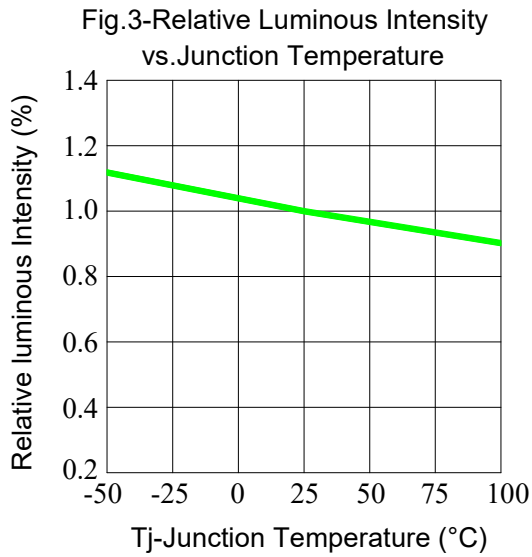
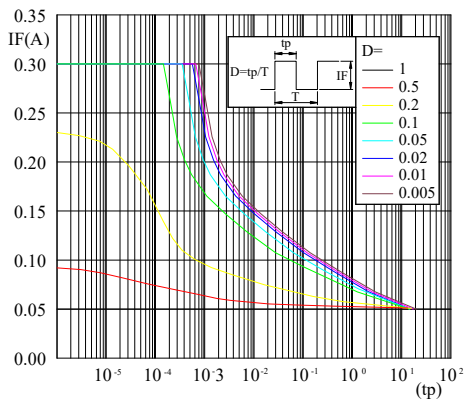

Fig.7-Permissible Pulse Handling Capability
I_F=f(tp) ; D=Duty cycle ; T_a=25°C



■ **Moisture Resistant Packing Materials**

1. **Label Explanation**

AMICC

AMICC OPTO-ELECTRONICS
TECHNOLOGY Co.,LTD



RoHS

P/N: ××××××××

TYPE: ×-××××××××

	CODE	MIN	MAX	UNIT
IV:	××	××	××	lm
HUE:	××	××	××	
VF:	××	××	××	V
LOT NO:	××××××××			QTY: ××××



MADE IN CHINA

- CPN: Customer's Product Number
- P/N: Product Number
- TYPE: Part NO.
- IV: Luminous Intensity Rank
- HUE: Chromaticity Coordinates Rank
- VF: Forward Voltage Rank
- LOT No: Lot Number
- QTY: Packing Quantity

2. **Reel Dimensions**

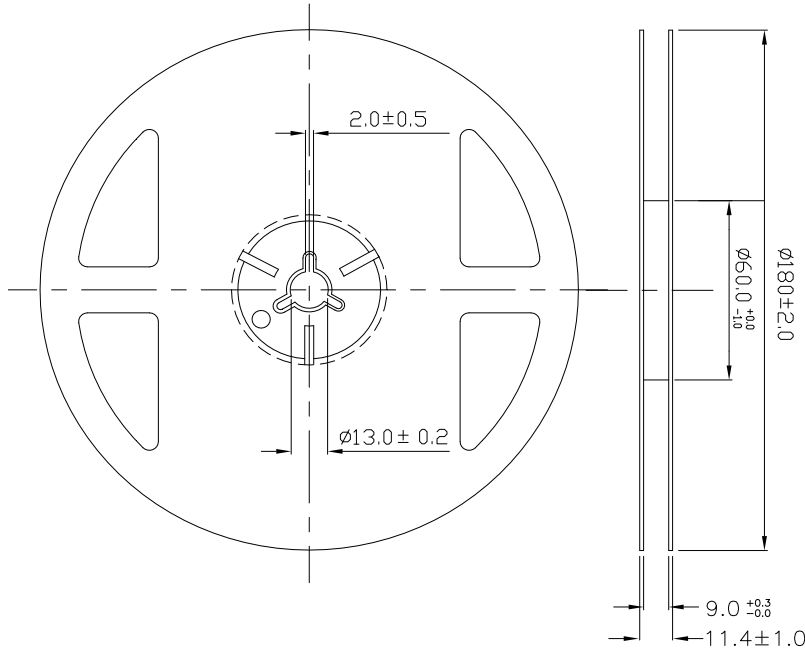

Notes:

1. Dimensions are in millimeters
2. Tolerances unless mentioned ± 0.1 mm.

3. Carrier Tape Dimensions: Loaded Quantity 4000 pcs Per Reel

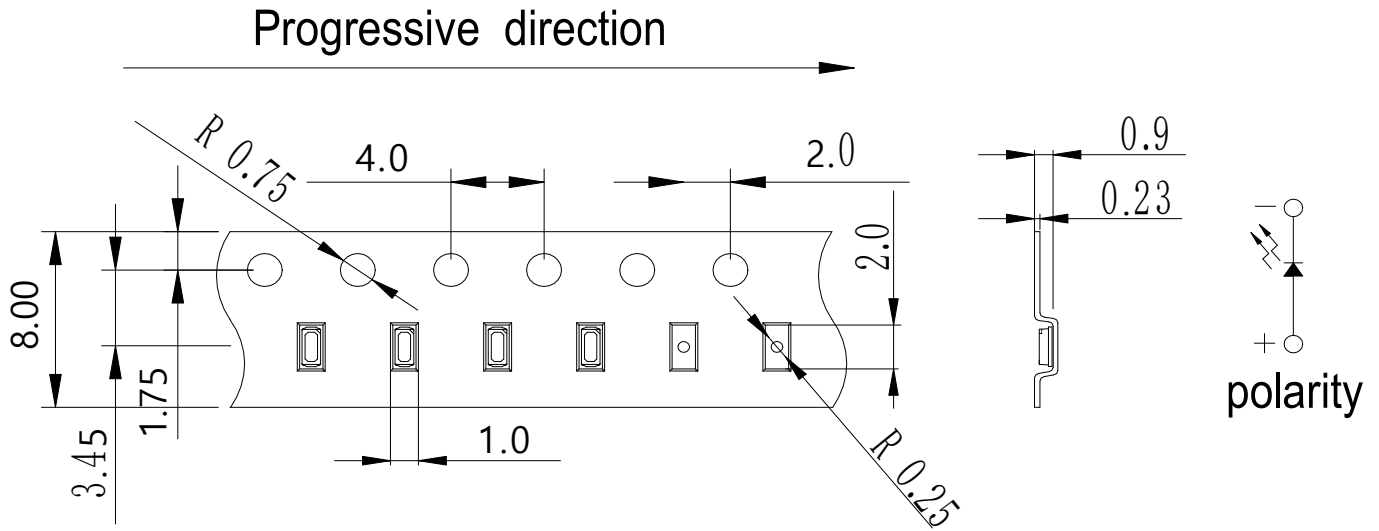

Notes:

1. Dimensions are in millimeters
2. Tolerance is unless mentioned ± 0.1 mm;
3. Minimum packing amount is 1000/2000/3000 pcs per reel.

4. Moisture Resistant Packing Process

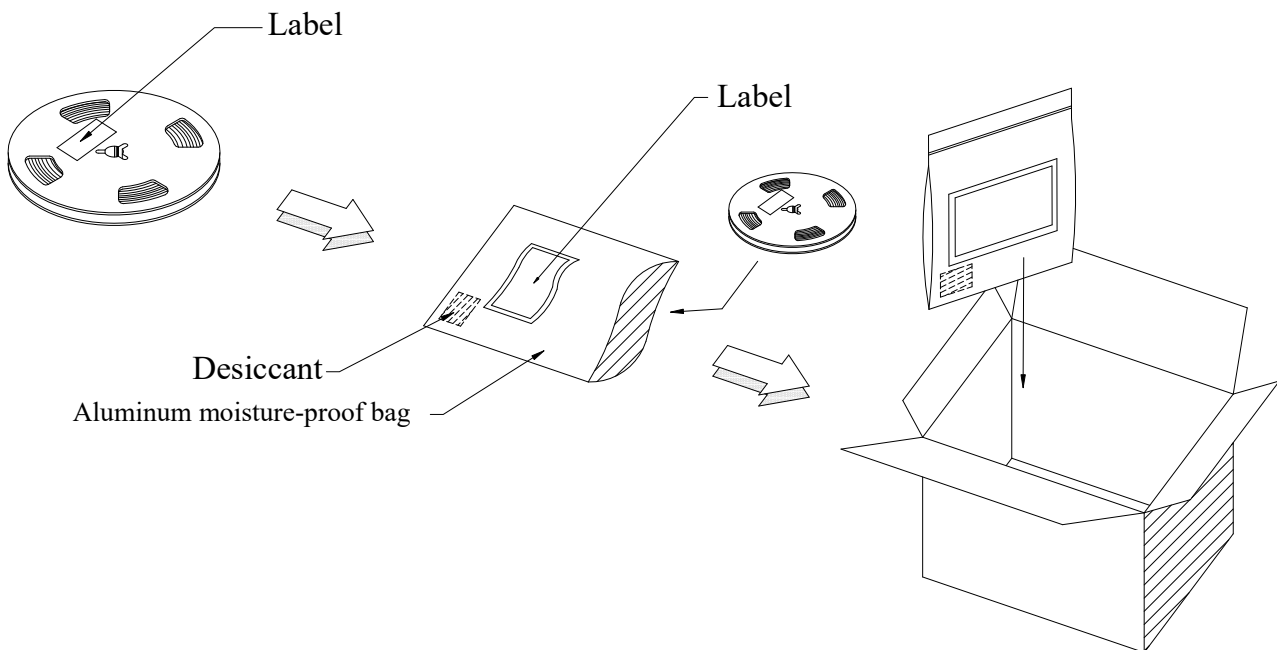

■ **Reliability Test Items and Conditions**

The reliability of products shall be satisfied with items listed below.

Confidence level : 90%

LTPD : 10%

No.	Items	Test Condition	Test Hours/Cycles	Sample Size	Ac/Re
1	Reflow Soldering	Temp. : 260°C/10sec.	6 Min.	22 PCS.	0/1
2	Thermal Shock	H : +100°C 5min \int 10 sec L : -10°C 5min	300 Cycles	22 PCS.	0/1
3	Temperature Cycle	H : +100°C 15min \int 5 min L : -40°C 15min	300 Cycles	22 PCS.	0/1
4	High Temperature/Humidity	Ta=85°C,85%RH	1000 Hrs.	22 PCS.	0/1
5	Low Temperature Storage	Ta=-40°C	1000 Hrs.	22 PCS.	0/1
6	High Temperature Storage	Ta=100°C	1000 Hrs.	22 PCS.	0/1
7	DC Operation Life	Ts=25°C, If =20 mA	1000 Hrs.	22 PCS.	0/1

■ Precautions for Use

1. Over-current-proof

Customer must apply resistors for protection; otherwise slight voltage shift will cause big current change (Burn out will happen).

2. Storage

2.1 Do not open moisture proof bag before the products are ready to use.

2.2 Before opening the package: The LEDs should be kept at 30°C or less and 90%RH or less.

2.3 After opening the package: The LED's floor life is 168 Hrs under 30°C or less and 60% RH or less. If unused LEDs remain, it should be stored in moisture proof packages.

2.4 If the moisture absorbent material (silica gel) has faded away or the LEDs have exceeded the storage time, baking treatment should be performed using the following conditions.

Baking treatment: 60±5°C for 24 hours.

3. Soldering Condition

3.1 Pb-free solder temperature profile

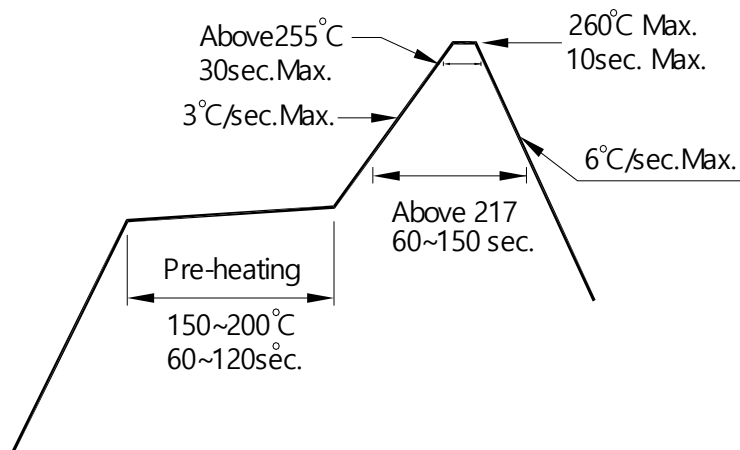

3.2 Reflow soldering should not be done more than two times.

3.3 When soldering, do not put stress on the LEDs during heating.

3.4 After soldering, do not warp the circuit board.

4. Soldering Iron

Each terminal is to go to the tip of soldering iron temperature less than 350°C for 3 seconds within once in less than the soldering iron capacity 25W. Leave two seconds and more intervals, and do soldering of each terminal. Be careful because the damage of the product is often started at the time of the hand solder.

5. Repairing

Repair should not be done after the LEDs have been soldered. When repairing is unavoidable, a double-head soldering iron should be used (as below figure). It should be confirmed beforehand whether the characteristics of the LEDs will or will not be damaged by repairing.

