

RECOMMENDED PCB(CONNECTOR SIDE VIEW) THICKNESS=1.6 TO 2.4 MM.

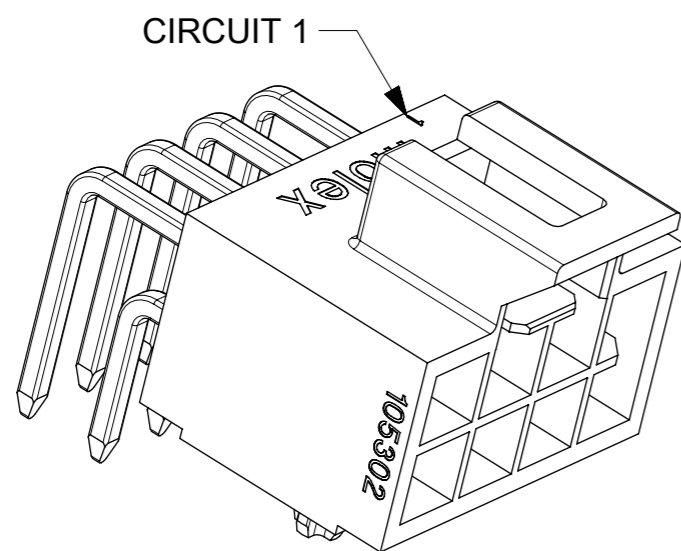

OPTION 1: LATCH FLUSH WITH PCB EDGE.  
 OPTION 2: HOUSING BODY FLUSH WITH PCB EDGE.

<b>QUALITY SYMBOLS</b> ▽ = 0 ▽ = 0 ▽ = 0 ▼ = 0 ▽ = 0 ⊠ = 0 ■ = 0 ▽ = 0	THIS DRAWING CONTAINS INFORMATION THAT IS PROPRIETARY TO MOLEX ELECTRONIC TECHNOLOGIES, LLC AND SHOULD NOT BE USED WITHOUT WRITTEN PERMISSION										
	2020/09/09	2020/09/10	2020/09/10	GENERAL TOLERANCES (UNLESS SPECIFIED)		DIMENSION UNITS		SCALE			
	EC NO: 644963	DRWN: GLLI	CHK'D: YXZHENG	ANGULAR TOL ± 3.0 °		mm					
				4 PLACES	±	DRWN BY	DATE		HEADER OF NANO-FIT, D/R, R/A POWER CONNECTOR		
				3 PLACES	± 0.1	GLLI	2015/06/05				
				2 PLACES	± 0.2	CHK'D BY	DATE		PRODUCT CUSTOMER DRAWING		
				1 PLACE	± 0.3	APP'R BY	DATE				
				0 PLACES	±	AYIN	2016/04/27		SERIES	MATERIAL NUMBER	CUSTOMER
				DRAFT WHERE APPLICABLE MUST REMAIN WITHIN DIMENSIONS		DRAWING SIZE	THIRD ANGLE PROJECTION		105314	SEE SHEET 2	GENERAL MARKET
						A3			DOCUMENT NUMBER	DOC TYPE	DOC PART
								SD-105314-100	PSD	000	1 OF 5

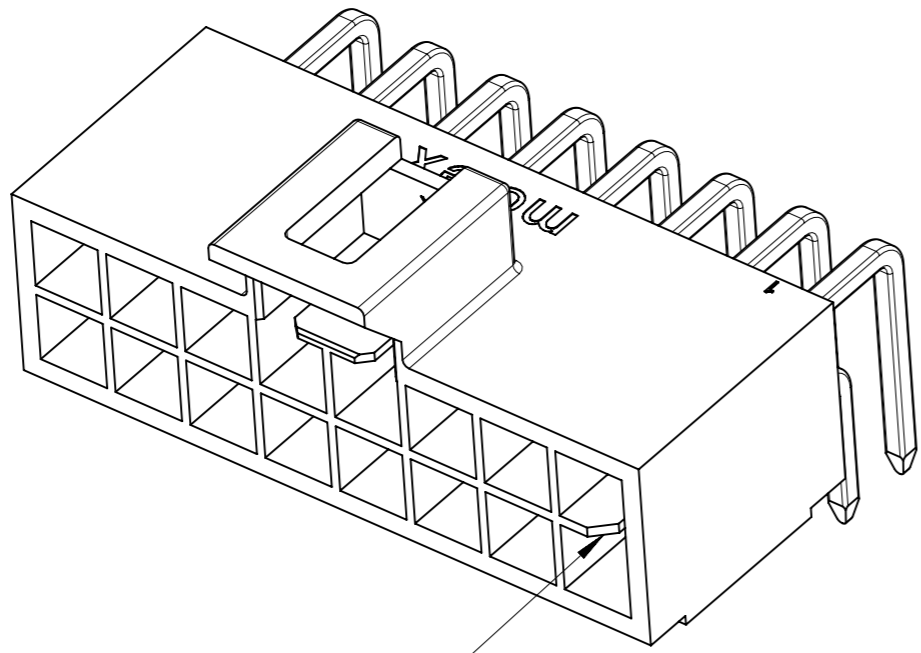

KEY A

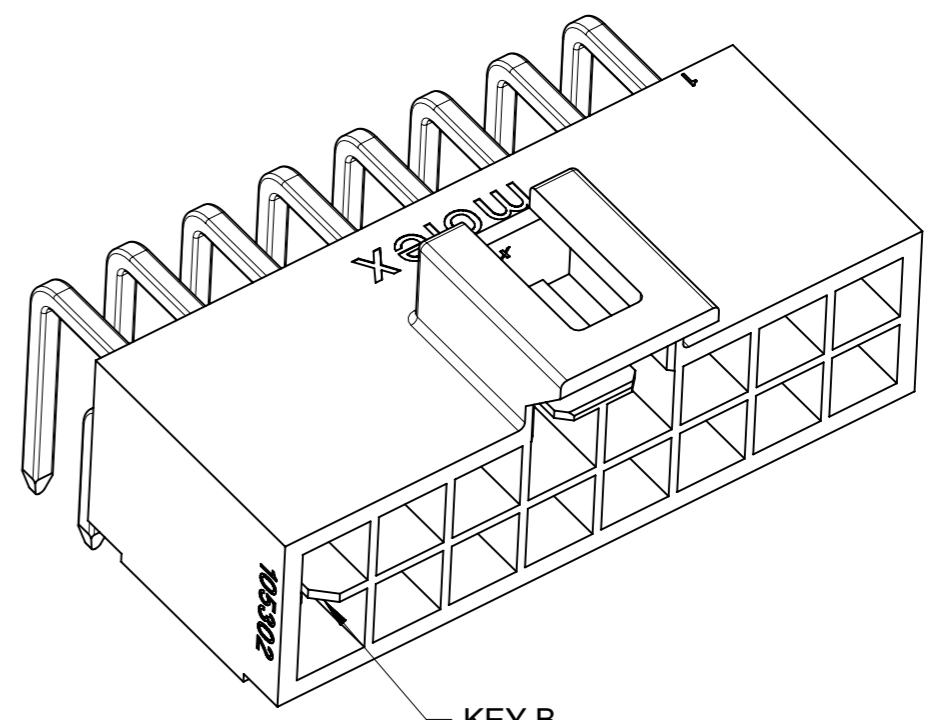

KEY B

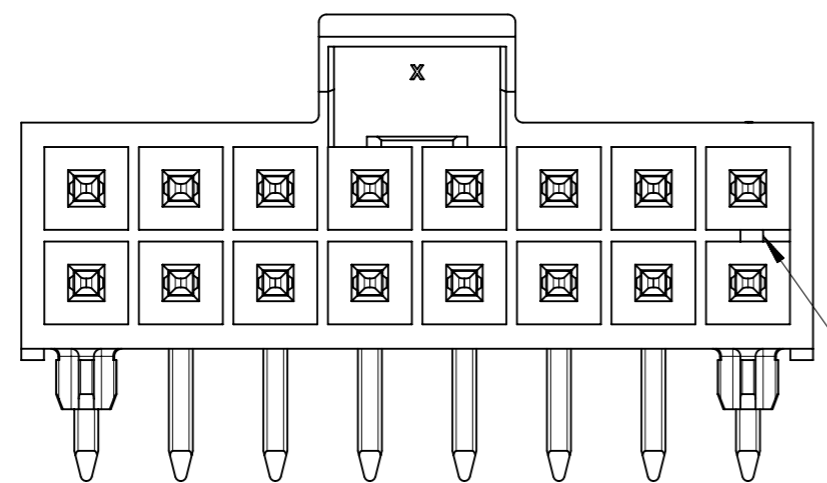

KEY A

BLACK

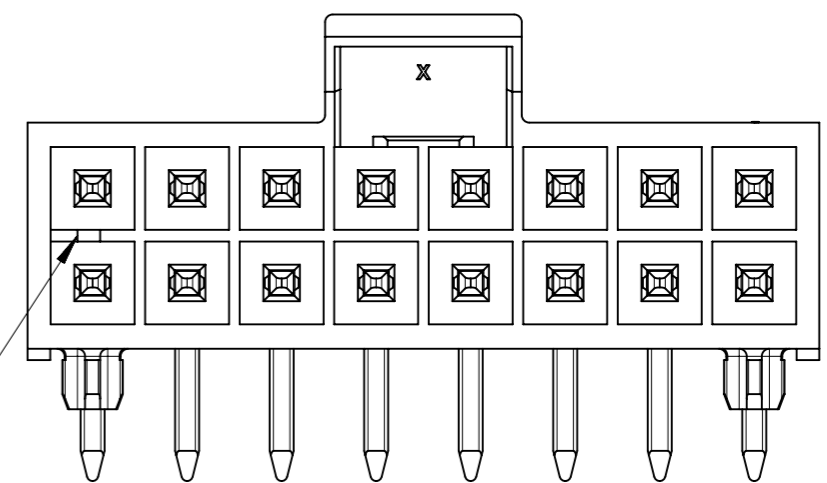

KEY B

NATURAL

COLOR OPTION

SYMBOLS		THIS DRAWING CONTAINS INFORMATION THAT IS PROPRIETARY TO MOLEX ELECTRONIC TECHNOLOGIES, LLC AND SHOULD NOT BE USED WITHOUT WRITTEN PERMISSION		CURRENT REV DESC:		<b>molex</b>		
DIMENSION UNITS		SCALE						
▽ = 0	mm			EC NO: 644963		HEADER OF NANO-FIT, D/R, R/A POWER CONNECTOR		
GENERAL TOLERANCES (UNLESS SPECIFIED)				DRWN: GLLI 2020/09/09		PRODUCT CUSTOMER DRAWING		
▽ = 0	ANGULAR TOL ± 3.0°			CHK'D: YXZHENG 2020/09/10		DOCUMENT NUMBER		
▽ = 0	4 PLACES ±			APPR: YXZHENG 2020/09/10		SD-105314-100		
▽ = 0	3 PLACES ± 0.1			INITIAL REVISION:		DOC TYPE DOC PART REVISION		
▽ = 0	2 PLACES ± 0.2			DRWN: GLLI 2015/06/05		PSD 000 H		
▽ = 0	1 PLACE ± 0.3			APPR: AYIN 2016/04/27		MATERIAL NUMBER		
▽ = 0	0 PLACES ±			THIRD ANGLE PROJECTION		CUSTOMER		
▽ = 0	DRAFT WHERE APPLICABLE MUST REMAIN WITHIN DIMENSIONS			DRAWING		SHEET NUMBER		
▽ = 0				A3-SIZE		GENERAL MARKET 2 OF 5		
▽ = 0				SERIES		105314		

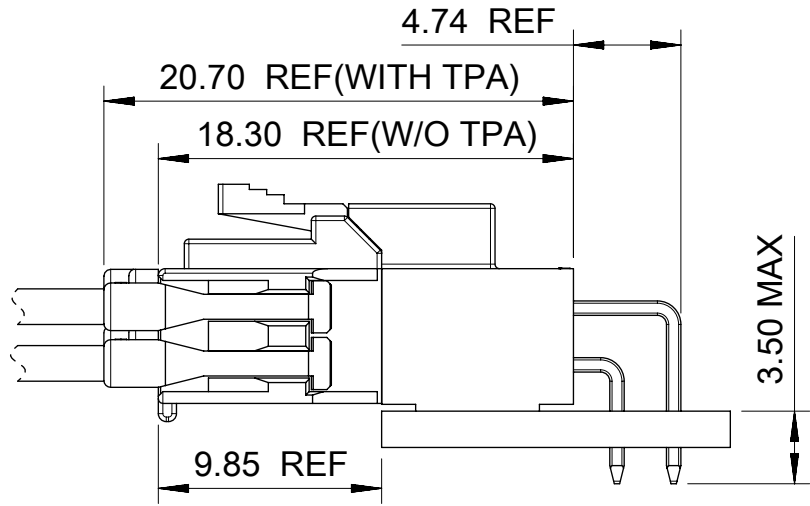
9		8		7		6		5		4		3		2		1																				
PART NUMBER	DIM 'A'	DIM 'B'	DIM 'C'	CKT SIZE	PLATING	LUBE																														
105314-1104	5.94	2.50	3.14	4	TIN																															
105314-1106	8.44	5.00	5.64	6																																
105314-1108	10.94	7.50	8.14	8																																
105314-1110	13.44	10.00	10.64	10																																
105314-1112	15.94	12.50	13.14	12																																
105314-1114	18.44	15.00	15.64	14																																
105314-1116	20.94	17.50	18.14	16																																
105314-1204	5.94	2.50	3.14	4	GOLD 0.38	NO											<p>105314- * * * *</p> <p>CIRCUIT SIZE</p> <p>PLATING OPTION</p> <p>1 - TIN</p> <p>2 - GOLD 0.38</p> <p>3 - GOLD 0.76</p> <p>4 - GOLD AND LUBE</p> <p>COLOR OPTION</p> <p>1 - BLACK</p> <p>2 - NATURAL</p>																			
105314-1206	8.44	5.00	5.64	6																																
105314-1208	10.94	7.50	8.14	8																																
105314-1210	13.44	10.00	10.64	10																																
105314-1212	15.94	12.50	13.14	12																																
105314-1214	18.44	15.00	15.64	14																																
105314-1216	20.94	17.50	18.14	16																																
105314-1304	5.94	2.50	3.14	4	GOLD 0.76																						<p>COLOR: BLACK</p>									
105314-1306	8.44	5.00	5.64	6																																
105314-1308	10.94	7.50	8.14	8																																
105314-1310	13.44	10.00	10.64	10																																
105314-1312	15.94	12.50	13.14	12																																
105314-1314	18.44	15.00	15.64	14																																
105314-1316	20.94	17.50	18.14	16																																
105314-1404	5.94	2.50	3.14	4	GOLD 0.76	YES	<p>COLOR: NATURAL</p>																													
105314-1406	8.44	5.00	5.64	6																																
105314-1408	10.94	7.50	8.14	8																																
105314-1410	13.44	10.00	10.64	10																																
105314-1412	15.94	12.50	13.14	12																																
105314-1414	18.44	15.00	15.64	14																																
105314-1416	20.94	17.50	18.14	16																																

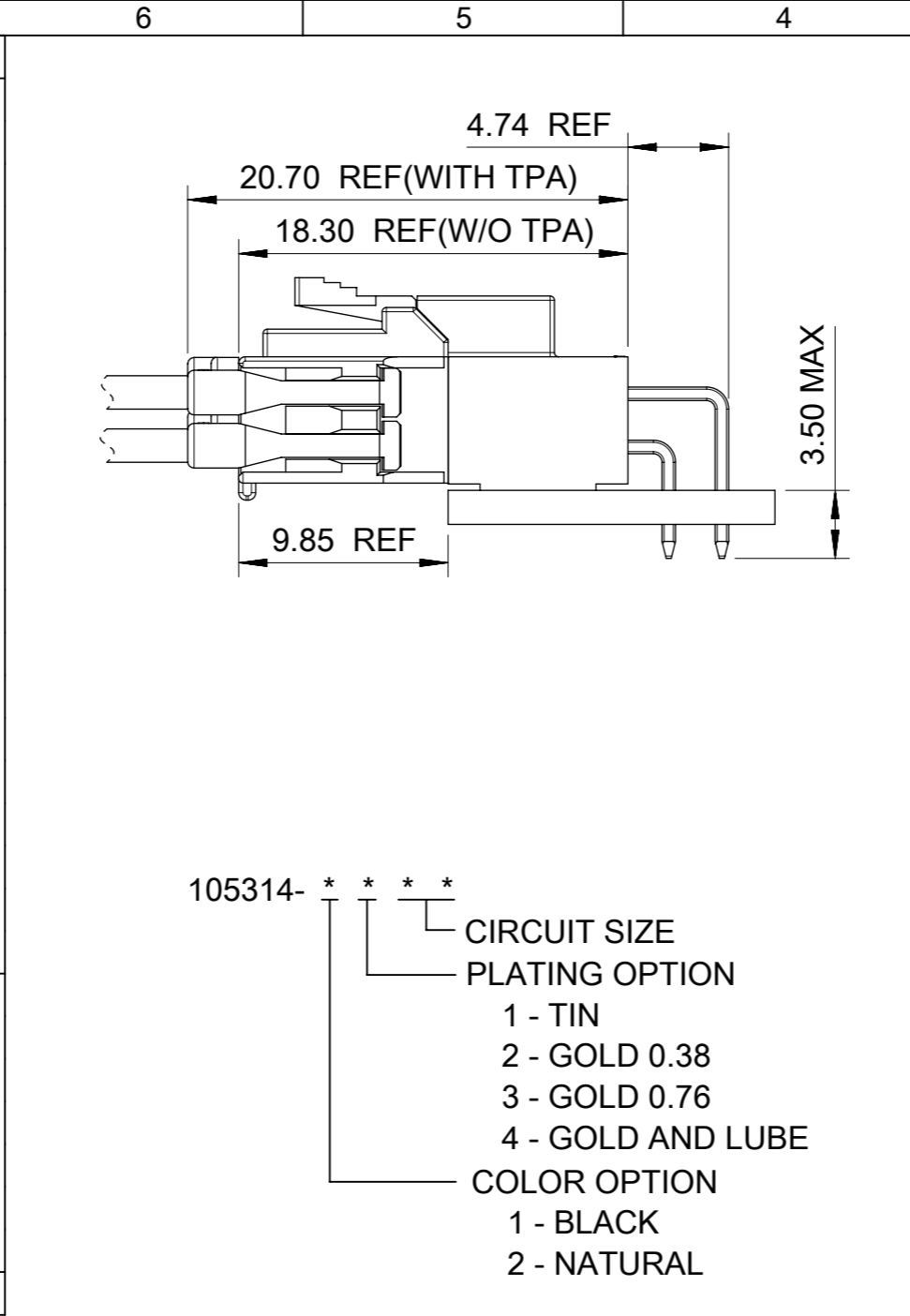

9		8		7		6		5		4		3		2		1																				
PART NUMBER	DIM 'A'	DIM 'B'	DIM 'C'	CKT SIZE	PLATING	LUBE																														
105314-2104	5.94	2.50	3.14	4	TIN		<p>COLOR: NATURAL</p>																													
105314-2106	8.44	5.00	5.64	6																																
105314-2108	10.94	7.50	8.14	8																																
105314-2110	13.44	10.00	10.64	10																																
105314-2112	15.94	12.50	13.14	12																																
105314-2114	18.44	15.00	15.64	14																																
105314-2116	20.94	17.50	18.14	16																																
105314-2204	5.94	2.50	3.14	4	GOLD 0.38	NO											<p>COLOR: NATURAL</p>																			
105314-2206	8.44	5.00	5.64	6																																
105314-2208	10.94	7.50	8.14	8																																
105314-2210	13.44	10.00	10.64	10																																
105314-2212	15.94	12.50	13.14	12																																
105314-2214	18.44	15.00	15.64	14																																
105314-2216	20.94	17.50	18.14	16																																
105314-2304	5.94	2.50	3.14	4	GOLD 0.76																						<p>COLOR: NATURAL</p>									
105314-2306	8.44	5.00	5.64	6																																
105314-2308	10.94	7.50	8.14	8																																
105314-2310	13.44	10.00	10.64	10																																
105314-2312	15.94	12.50	13.14	12																																
105314-2314	18.44	15.00	15.64	14																																
105314-2316	20.94	17.50	18.14	16																																
105314-2404	5.94	2.50	3.14	4	GOLD 0.76	YES	<p>COLOR: NATURAL</p>																													
105314-2406	8.44	5.00	5.64	6																																
105314-2408	10.94	7.50	8.14	8																																
105314-2410	13.44	10.00	10.64	10																																
105314-2412	15.94	12.50	13.14	12																																
105314-2414	18.44	15.00	15.64	14																																
105314-2416	20.94	17.50	18.14	16																																

105314- \* \* \* \*

CIRCUIT SIZE

PLATING OPTION

1 - TIN

2 - GOLD 0.38

3 - GOLD 0.76

4 - GOLD AND LUBE

COLOR OPTION

1 - BLACK







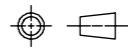

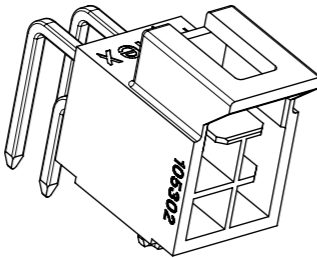
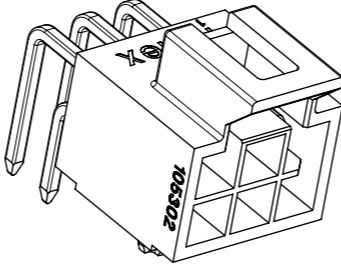
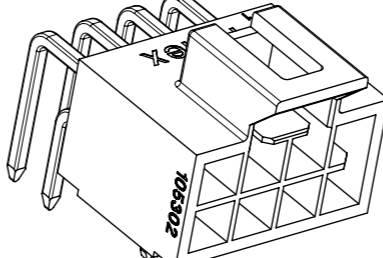
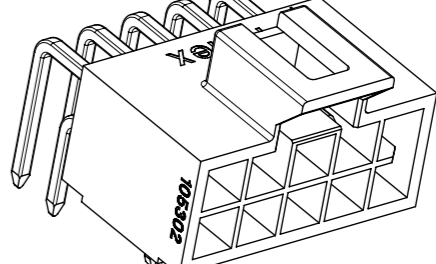
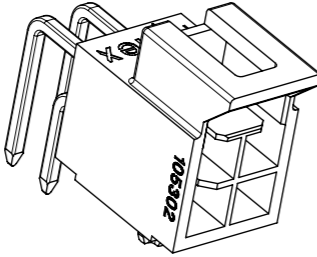
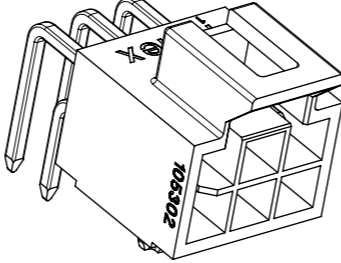
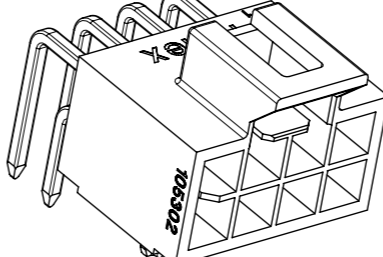
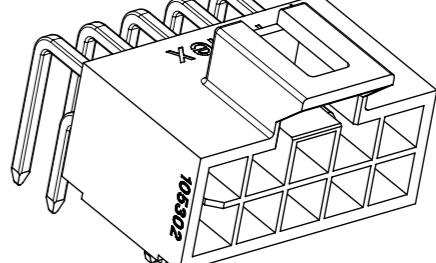
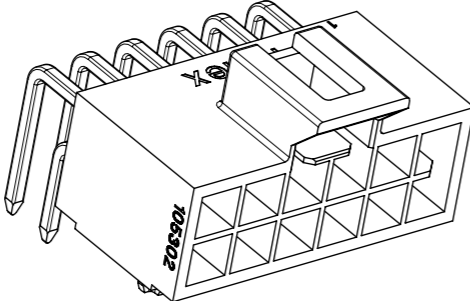
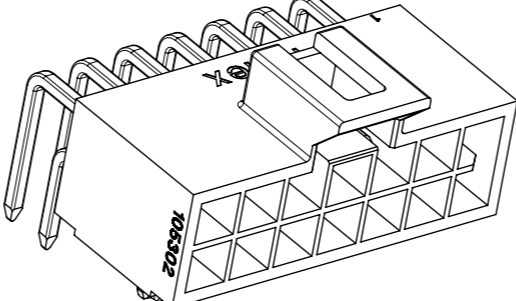
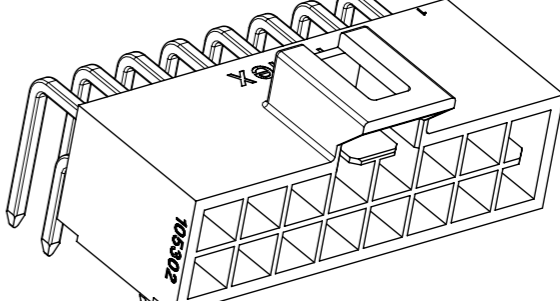
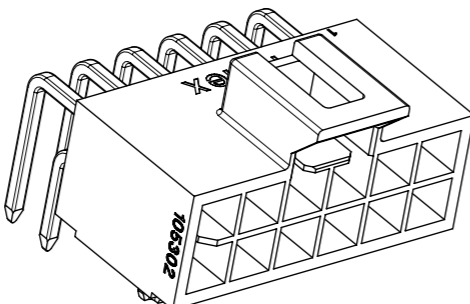
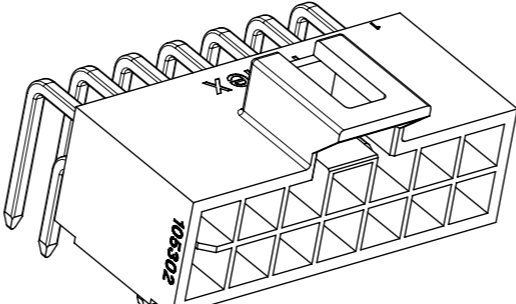
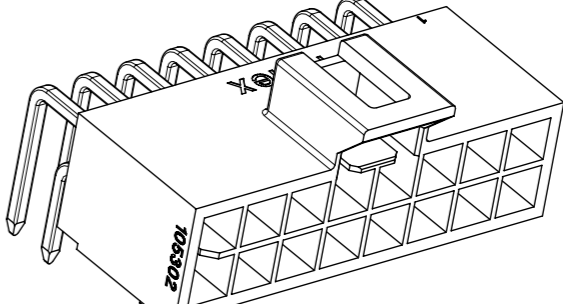
2 - NATURAL

COLOR: BLACK

COLOR: NATURAL

<p>QUALITY SYMBOLS</p> <p>▽A = 0</p> <p>▽E = 0</p> <p>▽P = 0</p> <p>▼ = 0</p> <p>▽C = 0</p> <p>⊗ = 0</p> <p>■ = 0</p> <p>▽ = 0</p>										<p>THIS DRAWING CONTAINS INFORMATION THAT IS PROPRIETARY TO MOLEX ELECTRONIC TECHNOLOGIES, LLC AND SHOULD NOT BE USED WITHOUT WRITTEN PERMISSION</p>									
<p>2020/09/09</p> <p>2020/09/10</p> <p>2020/09/10</p>		<p>GENERAL TOLERANCES (UNLESS SPECIFIED)</p> <p>ANGULAR TOL ± 3.0 °</p>		<p>DIMENSION UNITS</p> <p>mm</p>		<p>SCALE</p>		<p><b>molex</b></p> <p>HEADER OF NANO-FIT, D/R, R/A POWER CONNECTOR</p>											
<p>EC NO: 644963</p> <p>DRWN: GLLI</p> <p>CHK'D: YXZHENG</p> <p>APPR: YXZHENG</p>		<p>4 PLACES ±</p> <p>3 PLACES ± 0.1</p> <p>2 PLACES ± 0.2</p> <p>1 PLACE ± 0.3</p> <p>0 PLACES ±</p>		<p>DRWN BY</p> <p>GLLI</p>		<p>DATE</p> <p>2015/06/05</p>						<p>PRODUCT CUSTOMER DRAWING</p>							
<p>DRAFT WHERE APPLICABLE MUST REMAIN WITHIN DIMENSIONS</p>		<p>APPR BY</p> <p>AYIN</p>		<p>DATE</p> <p>2016/04/27</p>		<p>DRAWING SIZE</p> <p>A3</p>		<p>THIRD ANGLE PROJECTION</p> 		<p>SERIES</p> <p>105314</p>		<p>MATERIAL NUMBER</p> <p>SEE CHART</p>		<p>CUSTOMER</p> <p>GENERAL MARKET</p>					
<p>RELEASE STATUS</p> <p>P1</p>		<p>RELEASE DATE</p> <p>2020/09/10</p>		<p>08:56:04</p>		<p>DOCUMENT NUMBER</p> <p>SD-105314-100</p>		<p>DOC TYPE</p> <p>PSD</p>		<p>DOC PART</p> <p>000</p>		<p>SHEET NUMBER</p> <p>3 OF 5</p>							

		4 CKT	6 CKT	8 CKT	10 CKT
BLACK					
NATURAL					
	12 CKT	14 CKT		16 CKT	
BLACK					
NATURAL					

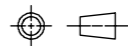
THIS DRAWING CONTAINS INFORMATION THAT IS PROPRIETARY TO MOLEX ELECTRONIC TECHNOLOGIES, LLC AND SHOULD NOT BE USED WITHOUT WRITTEN PERMISSION																													
<b>QUALITY SYMBOLS</b>  = 0  = 0  = 0  = 0  = 0  = 0  = 0  = 0  = 0		EC NO: 644963 DRWN: GLLI CHK'D: YXZHENG APPR: YXZHENG			2020/09/09 2020/09/10 2020/09/10			<b>GENERAL TOLERANCES (UNLESS SPECIFIED)</b> ANGULAR TOL ± 3.0 ° 4 PLACES ± 3 PLACES ± 0.1 2 PLACES ± 0.2 1 PLACE ± 0.3 0 PLACES ±			DRAFT WHERE APPLICABLE MUST REMAIN WITHIN DIMENSIONS			DIMENSION UNITS <b>mm</b>		SCALE DATE 2015/06/05		DATE 2016/04/27		DRWN BY <b>GLLI</b>		CHK'D BY DATE		APPR BY <b>AYIN</b>		DRAWING SIZE <b>A3</b>		THIRD ANGLE PROJECTION 	
<b>molex®</b>																													
HEADER OF NANO-FIT, D/R, R/A POWER CONNECTOR																													
PRODUCT CUSTOMER DRAWING																													
SERIES		MATERIAL NUMBER			CUSTOMER																								
105314		SEE SHEET 2			GENERAL MARKET																								
DOCUMENT NUMBER				DOC TYPE		DOC PART		SHEET NUMBER																					
SD-105314-100				PSD		000		4 OF 5																					

NOTES FOR ALL PARTS

1> MATERIAL:  
 HOUSING: LCP, UL 94V-0.  
 TERMINAL: BRASS.  
 SOLDER CLIP: BRASS.

2> PLATING FINISHED:  
 TERMINAL:  
 CONTACT AREA: a. REFLOWED MATTE TIN 1.5MICRONS MIN;  
 b. GOLD 0.38 MICRONS MIN;  
 c. GOLD 0.76 MICRONS MIN.  
 SOLDER AREA: TIN 1.5 MICRONS MIN, UNDER PLATING NICKEL 1.25 MICRONS MIN.  
 SOLDER CLIP: TIN 2.5 MICRONS MIN, UNDER PLATING NICKEL 1.25 MICRONS MIN.

3> PRODUCT SPECIFICATION: PS-105300-100.  
 4> PACKAGE: TRAY, PK-105309-200.  
 5> ALL COMPONENTS AND PRODUCT COMPLIANT TO RoHS DIRECTIVE 2011/65/EU AND ELV DIRECTIVE 2000/53/EC.  
 6> PRODUCT MATE WITH SERIES OF 105308(RECEPTACLE), 105300(CRIMP TERMINAL).  
 7> PARTS CONFORM TO CLASS 'B'REQUIREMENTS OF COSMETIC SPECIFICATION PS-45499-002.  
 8> DISCOLORATION IN THE BANDOLIER PIN CARRIER AREA OF THE PIN IS INHERENT TO THE PLATING PROCESS AND IS DUE TO THE MASKING DEFECT OF THE CARRIER, THIS DISCOLORATION IS IN A NON-FUNCTION AREA OF THE PIN AND WILL NOT AFFECT THE PERFORMANCE OF THE HEADER ASSEMBLY.

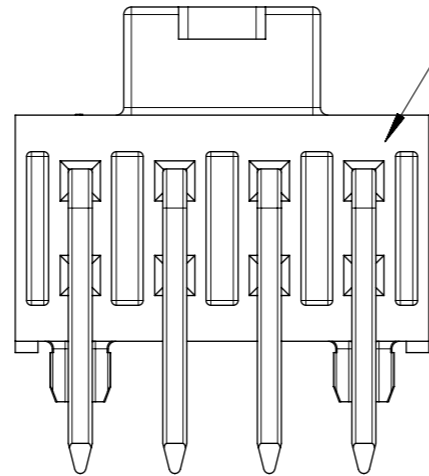

IF ANY NUMBER MARK APPEARS ON THIS SURFACE, PLEASE DISREGARD IT, IT IS NO ANY FUCTION AND NO ANY RELATION TO PIN NUMBER, IT IS JUST FOR MOLDING IDENTIFICATION.

QUALITY SYMBOLS ▽ = 0 ▽ = 0 ▽ = 0 ▼ = 0 ▽ = 0 ⊗ = 0 ■ = 0 ▽ = 0	THIS DRAWING CONTAINS INFORMATION THAT IS PROPRIETARY TO MOLEX ELECTRONIC TECHNOLOGIES, LLC AND SHOULD NOT BE USED WITHOUT WRITTEN PERMISSION												
	EC NO: 644963 DRWN: GLLI CHK'D: YXZHENG APPR: YXZHENG	2020/09/09		2020/09/10		2020/09/10		GENERAL TOLERANCES (UNLESS SPECIFIED)		DIMENSION UNITS		SCALE	
		mm				DRWN BY		DATE		GLLI 2015/06/05			
		ANGULAR TOL ± 3.0 °		4 PLACES ±		CHK'D BY		DATE					
		3 PLACES ± 0.1		3 PLACES ± 0.2		APPR BY		DATE					
		2 PLACES ± 0.3		0 PLACES ±		AYIN		2016/04/27					
	DRAFT WHERE APPLICABLE MUST REMAIN WITHIN DIMENSIONS		A3		DRAWING SIZE		THIRD ANGLE PROJECTION						
									PRODUCT CUSTOMER DRAWING		SERIES: 105314 MATERIAL NUMBER: SEE SHEET 2 CUSTOMER: GENERAL MARKET		
									DOCUMENT NUMBER: SD-105314-100 DOC TYPE: PSD DOC PART: 000 SHEET NUMBER: 5 OF 5				