

Description

The AU1501D5 is an uni-directional TVS diode, utilizing leading monolithic silicon technology to provide fast response time and ultra low ESD clamping voltage, making this device an ideal solution for protecting voltage sensitive data and power line. The AU1501D5 complies with the IEC 61000-4-2 (ESD) with $\pm 30\text{kV}$ air and $\pm 30\text{kV}$ contact discharge. It is assembled into an ultra-small SOD-523 lead-free package. The small size and high ESD surge protection make AU1501D5 an ideal choice to protect cell phone, digital cameras, audio players and many other portable applications.

Features

- Protects one line
- Ultra low leakage: nA level
- Operating voltage: 15V
- Low clamping voltage
- Complies with following standards:
 - IEC 61000-4-2 (ESD) immunity test
 - Air discharge: $\pm 30\text{kV}$
 - Contact discharge: $\pm 30\text{kV}$
 - IEC61000-4-5 (Lightning) 11A (8/20 μs)
- RoHS Compliant

Mechanical Characteristics

- Package: SOD-523
- Case Material: “Green” Molding Compound.
- Lead Finish: Matte Tin
- Moisture Sensitivity: Level 3 per J-STD-020
- Terminal Connections: See Diagram Below
- Marking Information: See Below

Applications

- Cellular Handsets and Accessories
- Personal Digital Assistants
- Notebooks, Desktops, Servers
- Portable Instrumentation
- Printers
- Analog Inputs
- Video equipment
- Communication systems
- Laser Diode Protection

Marking Information



15E = Device Marking Code
 Bar denotes cathode

Dimensions and Pin Configuration

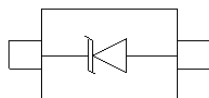

SOD-523 (Top View)

Circuit and Pin Schematic

Ordering Information

Part Number	Packaging	Reel Size
AU1501D5	3000/Tape & Reel	7 inch

Absolute Maximum Ratings ($T_A=25^{\circ}\text{C}$ unless otherwise specified)

Parameter	Symbol	Value	Unit
Peak Pulse Power (8/20 μs)	Ppk	350	W
Peak Pulse Current (8/20 μs)	Ipp	11	A
ESD per IEC 61000-4-2 (Air)	VESD	± 30	kV
ESD per IEC 61000-4-2 (Contact)		± 30	
Operating Temperature Range	TJ	-55 to +125	$^{\circ}\text{C}$
Storage Temperature Range	Tstg	-55 to +150	$^{\circ}\text{C}$

Electrical Characteristics ($T_A=25^{\circ}\text{C}$ unless otherwise specified)

Parameter	Symbol	Min	Typ	Max	Unit	Test Condition
Reverse Working Voltage	VRWM			15	V	
Breakdown Voltage	VBR	18			V	IT = 1mA
Reverse Leakage Current	IR			0.2	μA	VRWM = 15V
Clamping Voltage	VC			23	V	I _{PP} = 1A (8 x 20 μs pulse)
Clamping Voltage	VC			32	V	I _{PP} = 11A (8 x 20 μs pulse)
Junction Capacitance	CJ			80	pF	VR = 0V, f = 1MHz

Typical Performance Characteristics ($T_A=25^\circ\text{C}$ unless otherwise Specified)

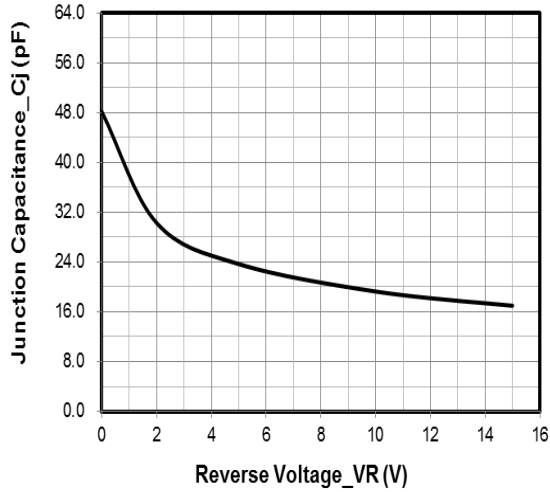

Junction Capacitance vs. Reverse Voltage

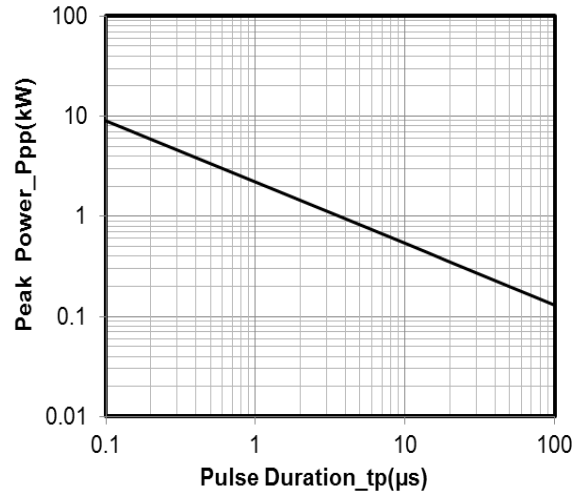

Peak Pulse Power vs. Pulse Time

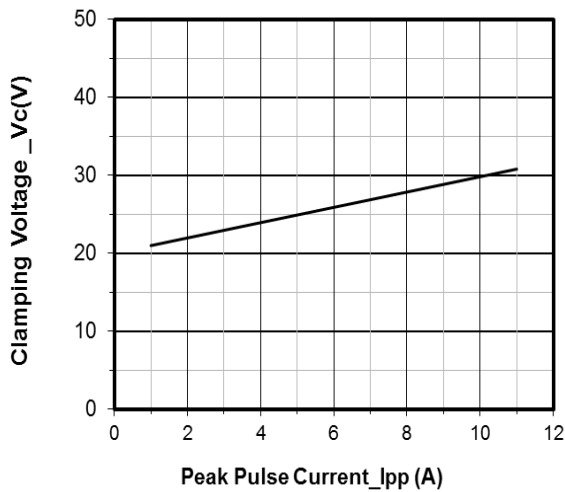

Clamping Voltage vs. Peak Pulse Current

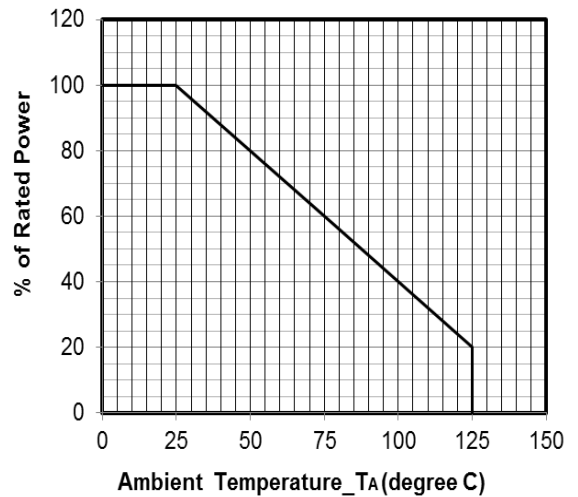

Power Derating Curve

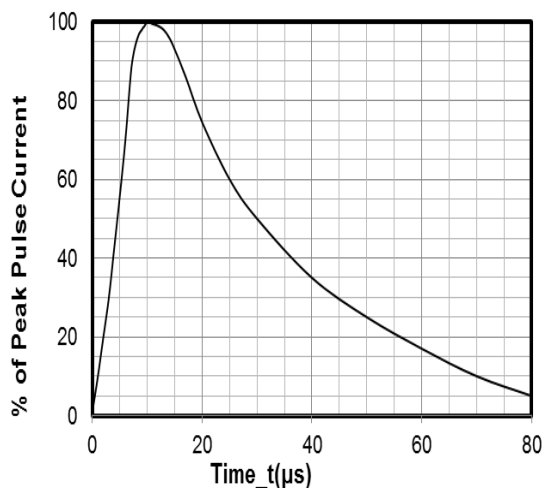

8 X 20μs Pulse Waveform

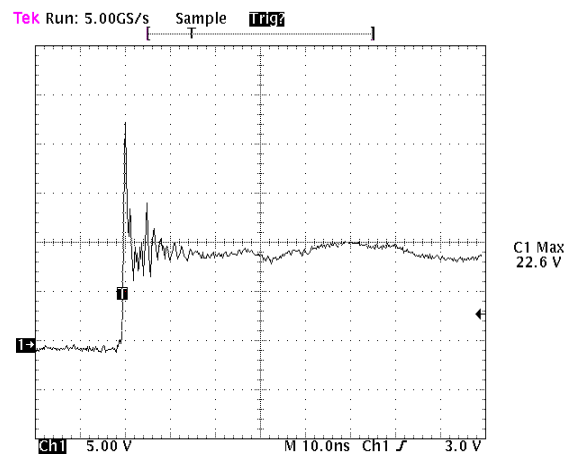

Note: Data is taken with a 10x attenuator
ESD Clamping Voltage
+8 kV Contact per IEC61000-4-2

SOD-523 Package Outline Drawing

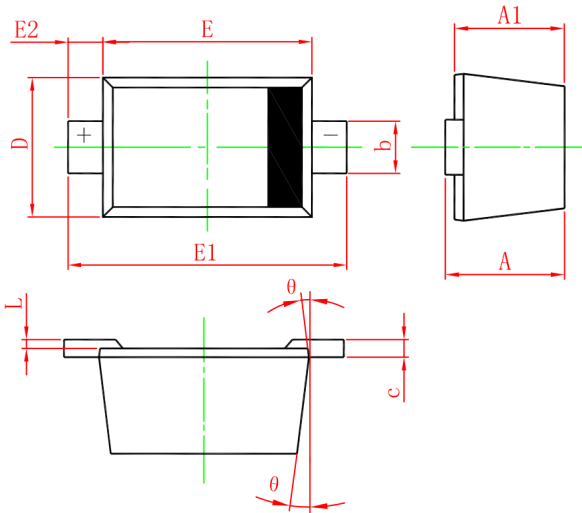

SYM	DIMENSIONS					
	MILLIMETERS			INCHES		
	MIN	NOM	MAX	MIN	NOM	MAX
A	0.51	--	0.77	0.020	--	0.031
A1	0.50	--	0.70	0.020	--	0.028
b	0.25	--	0.35	0.010	--	0.014
c	0.08	--	0.15	0.003	--	0.006
D	0.75	--	0.85	0.030	--	0.033
E	1.10	--	1.30	0.043	--	0.051
E1	1.50	--	1.70	0.059		0.067
E2	0.20REF			0.008REF		
L	0.01	--	0.07	0.001	--	0.003
Θ	7° REF			7° REF		

Suggested Land Pattern

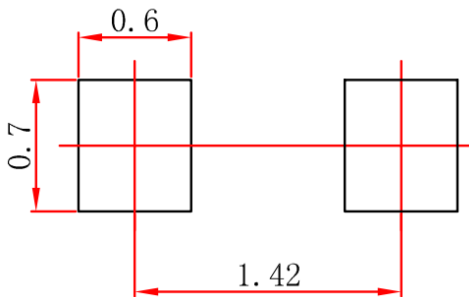

Unit: mm

Contact Information

Applied Power Microelectronics Co., Ltd.

Website: <http://www.appliedpowermicro.com>

Email: sales@appliedpowermicro.com

Phone: +86 (0519) 8399 3606