

Description

The AR1211D3 is a 12V bi-directional TVS diode, utilizing leading monolithic silicon technology to provide fast response time and low ESD clamping voltage, making this device an ideal solution for protecting voltage sensitive high-speed data lines. The AR1211D3 has a low capacitance with a typical value at 1pF, and complies with the IEC 61000-4-2 (ESD) with $\pm 30\text{kV}$ air and $\pm 30\text{kV}$ contact discharge. It is assembled into a lead-free SOD-323 package. The small size, low capacitance and high ESD surge protection make AR1211D3 an ideal choice to protect cell phone, wireless systems, and communication equipment.

Features

- 350W peak pulse power (8/20 μs)
- Ultra low capacitance: 1pF typical
- Ultra low leakage: nA level
- Operating voltage: 12V
- Low clamping voltage
- Protects one power line or data line
- Complies with following standards:
 - IEC 61000-4-2 (ESD) immunity test
Air discharge: $\pm 30\text{kV}$
Contact discharge: $\pm 30\text{kV}$
 - IEC61000-4-5 (Lightning) 14A (8/20 μs)
- RoHS Compliant

Dimensions and Pin Configuration

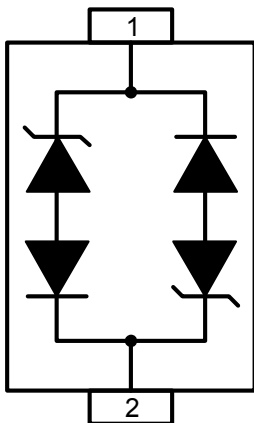

Circuit and Pin Schematic

Mechanical Characteristics

- Package: SOD-323
- Lead Finish: Matte Tin
- Case Material: “Green” Molding Compound.
- Moisture Sensitivity: Level 3 per J-STD-020
- Terminal Connections: See Diagram Below
- Marking Information: See Below

Applications

- USB Ports
- Smart Phones
- Wireless Systems
- Ethernet 10/100/1000 Base T

Marking Information

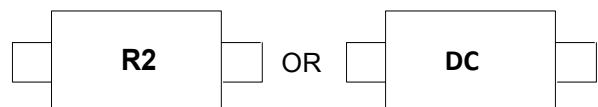

Ordering Information

Part Number	Packaging	Reel Size
AR1211D3	3000/Tape & Reel	7 inch

Absolute Maximum Ratings ($T_A=25^{\circ}\text{C}$ unless otherwise specified)

Parameter	Symbol	Value	Unit
Peak Pulse Power (8/20 μs)	Ppk	350	W
Peak Pulse Current (8/20 μs)	I _{PP}	14	A
ESD per IEC 61000-4-2 (Air)	V _{ESD}	± 30	kV
ESD per IEC 61000-4-2 (Contact)		± 30	
Operating Temperature Range	T _J	-55 to +125	$^{\circ}\text{C}$
Storage Temperature Range	T _{stg}	-55 to +150	$^{\circ}\text{C}$

Electrical Characteristics ($T_A=25^{\circ}\text{C}$ unless otherwise specified)

Parameter	Symbol	Min	Typ	Max	Unit	Test Condition
Reverse Working Voltage	V _{RWM}			12	V	
Breakdown Voltage	V _{BR}	13.3			V	I _T = 1mA
Reverse Leakage Current	I _R			0.2	μA	V _{RWM} = 12V
Clamping Voltage	V _C			18	V	I _{PP} = 1A (8 x 20 μs pulse)
Clamping Voltage	V _C			25	V	I _{PP} = 14A (8 x 20 μs pulse)
Junction Capacitance	C _J		1		pF	V _R = 0V, f = 1MHz

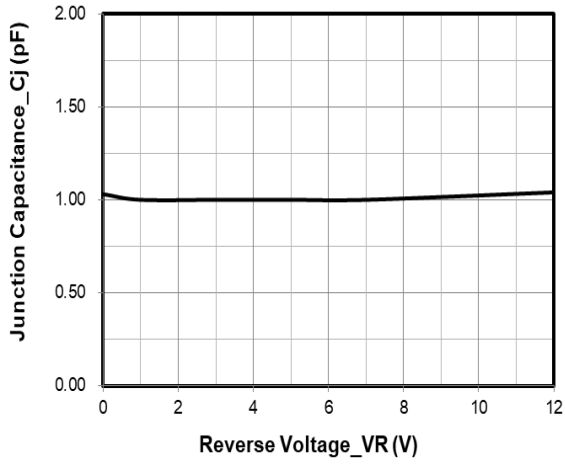
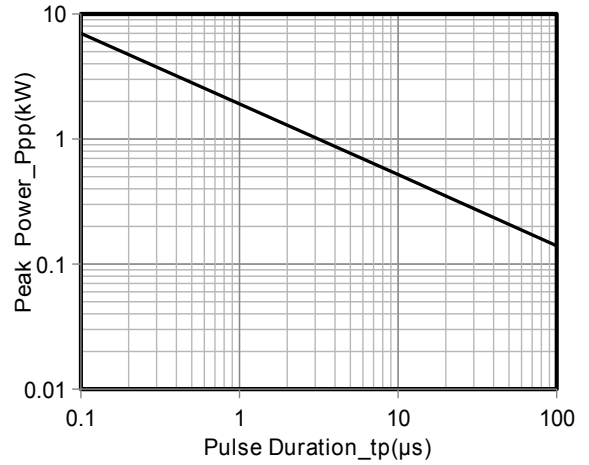
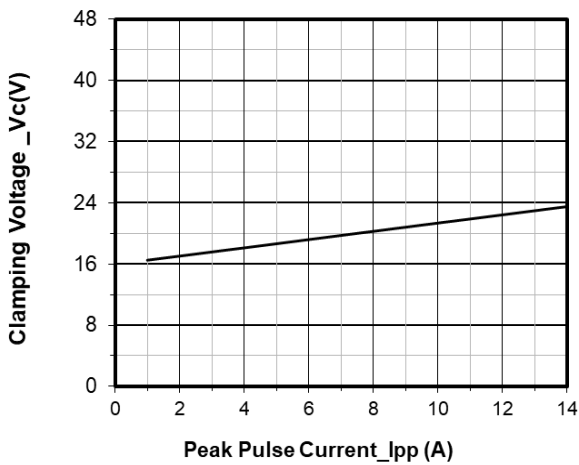
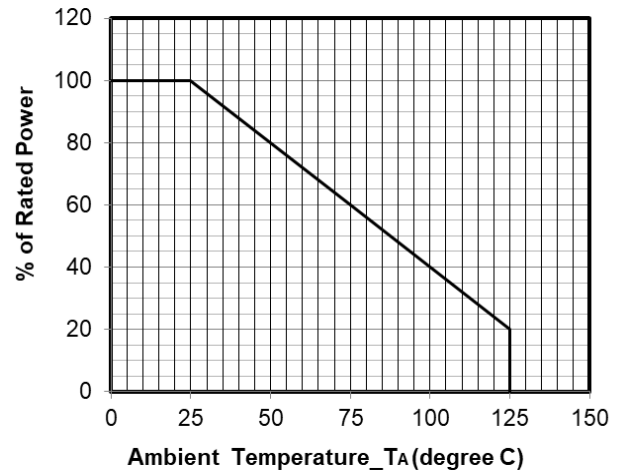
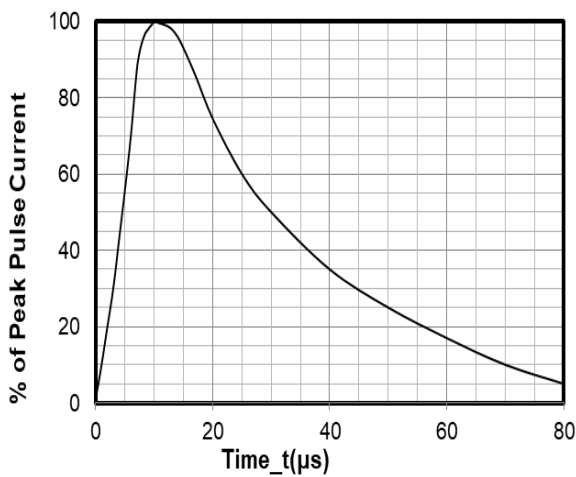
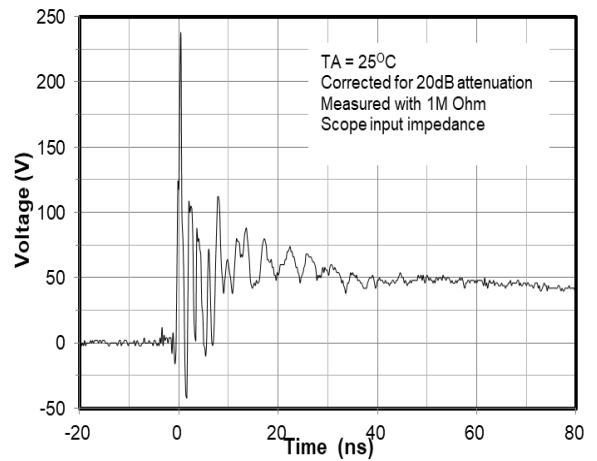
Typical Performance Characteristics (TA=25°C unless otherwise Specified)

Junction Capacitance vs. Reverse Voltage

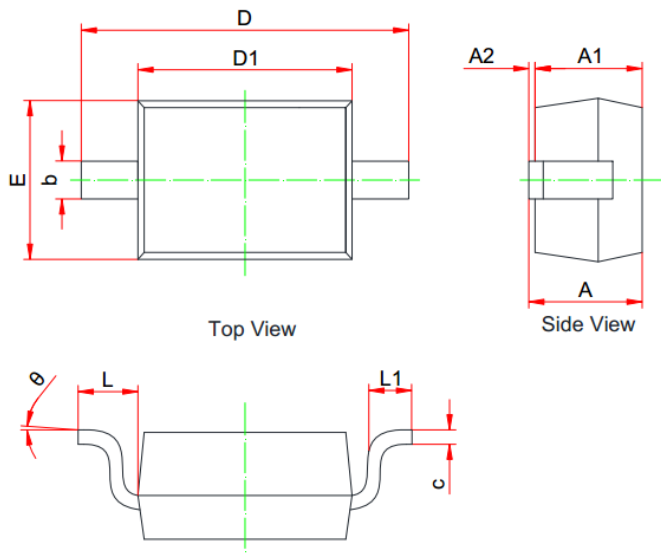
Peak Pulse Power vs. Pulse Time

Clamping Voltage vs. Peak Pulse Current

Power Derating Curve

8 X 20μs Pulse Waveform

**ESD Clamping Voltage
8 kV Contact per IEC61000-4-2**

SOD-323 Package Outline Drawing



SYM	MILLIMETERS		
	MIN	NOM	MAX
A	0.800	--	1.100
A1	0.800	--	0.900
A2	0.000	--	0.100
b	0.250	--	0.400
c	0.080	--	0.177
D1	1.600	1.700	1.800
D	2.300	--	2.800
E	1.150	--	1.400
L	0.475REF		
L1	0.100	--	0.500
Θ	0°	--	8°

Suggested Land Pattern



Unit: mm

Contact Information

Applied Power Microelectronics Co., Ltd.

Website: <http://www.appliedpowermicro.com>

Email: sales@appliedpowermicro.com

Phone: +86 (0519) 8399 3606