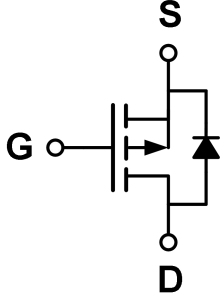
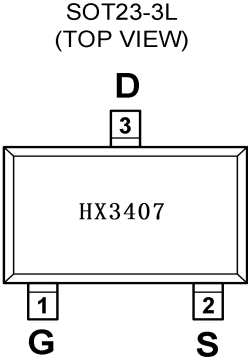

<p>DESCRIPTION</p> <p>The HX3407 uses advanced trench technology to provide excellent $R_{DS(ON)}$, low gate charge and high density cell Design for ultra low on-resistance. This device is suitable for use as a load switch or in PWM applications.</p> <p>GENERAL FEATURES</p> <ul style="list-style-type: none"> ◇ $V_{DS} = -30V$, $I_D = -4A$ $R_{DS(ON)}(Typ.) = 65m\Omega$ @ $V_{GS} = -4.5V$ $R_{DS(ON)}(Typ.) = 47m\Omega$ @ $V_{GS} = -10V$ ◇ High power and current handing capability ◇ Lead free product is acquired ◇ Surface mount package <p>APPLICATION</p> <ul style="list-style-type: none"> ◇ PWM applications ◇ Load switch <p>PACKAGE</p> <ul style="list-style-type: none"> ◇ SOT23-3L 	<p>SCHEMATIC DIAGRAM</p>  <p>PIN ASSIGNMENT</p> <p style="text-align: center;">SOT23-3L (TOP VIEW)</p> 
---	---

ORDERING INFORMATION

Part Number	Storage Temperature	Package	Marking	Devices Per Reel
HX3407	-55°C to +150°C	SOT23-3L	3407	3000

ABSOLUTE MAXIMUM RATINGS

($T_A = 25^\circ C$ unless otherwise noted)

parameter		symbol	limit	unit
Drain-source voltage		V_{DS}	-30	V
Gate-source voltage		V_{GS}	± 20	V
Continuous Drain Current	$T_C = 25^\circ C$	I_D	-4	A
	$T_C = 70^\circ C$		-3.0	
Pulsed Drain Current ^C		I_{DP}	-16	A
power dissipation ^B	$T_C = 25^\circ C$	P_D	1.4	W
	$T_C = 70^\circ C$		0.9	
Junction and Storage Temperature Range		T_J, T_{SGT}	-55—150	°C

THERMAL CHARACTERISTICS

Parameter		Symbol	Typ.	Max.	Unit
Maximum Junction-to-Ambient ^A	$t \leq 10s$	$R_{\theta JA}$	70	90	°C/W
Maximum Junction-to-Ambient ^{A D}	Steady-State		100	125	
Maximum Junction-to-Lead	Steady-State	$R_{\theta JL}$	62	80	

Notes

- A. The value of $R_{\theta JA}$ is measured with the device mounted on 1in² FR-4 board with 2oz. Copper, in a still air environment with $T_A = 25^\circ\text{C}$. The value in any given application depends on the user's specific board design.
- B. The power dissipation P_D is based on $T_{J(\text{MAX})} = 150^\circ\text{C}$, using $\leq 10s$ junction-to-ambient thermal resistance.
- C. Repetitive rating, pulse width limited by junction temperature $T_{J(\text{MAX})} = 150^\circ\text{C}$. Ratings are based on low frequency and duty cycles to keep initial $T_J = 25^\circ\text{C}$.
- D. The $R_{\theta JA}$ is the sum of the thermal impedance from junction to lead $R_{\theta JL}$ and lead to ambient.

ELECTRICAL CHARACTERISTICS ($T_A = 25^\circ\text{C}$ unless otherwise noted)

Parameter	Symbol	Condition	Min	Typ	Max	Unit
OFF Characteristics						
Drain-source breakdown voltage	BV_{DSS}	$V_{GS} = 0V, I_D = -250\mu A$	-30	-	-	V
Zero gate voltage drain current	I_{DSS}	$V_{DS} = -30V, V_{GS} = 0V$	-	-	-1	μA
Gate-body leakage	I_{GSS}	$V_{DS} = 0V, V_{GS} = \pm 20V$	-	-	± 100	nA
ON Characteristics						
Gate threshold voltage	$V_{GS(th)}$	$V_{DS} = V_{GS}, I_D = -250\mu A$	-1.0	-1.5	-2.2	V
Drain-source on-state resistance	$R_{DS(ON)}$	$V_{GS} = -10V, I_D = -4A$	-	47	60	m Ω
		$V_{GS} = -4.5V, I_D = -3A$	-	65	85	
Forward transconductance	G_{FS}	$V_{DS} = -5V, I_D = -1A$	-	10	-	S
Dynamic Characteristics						
Input capacitance	C_{ISS}	$V_{DS} = -10V, V_{GS} = 0V$ $f = 1.0\text{MHz}$	-	583	-	pF
Output capacitance	C_{OSS}		-	100	-	
Reverse transfer capacitance	C_{RSS}		-	80	-	
Switching Characteristics						
Turn-on delay time	$t_{D(ON)}$	$V_{DD} = -15V$ $I_D = -4A$ $V_{GEN} = -10V$ $R_L = 3.6\Omega$ $R_{GEN} = 3\Omega$	-	2.8	-	ns
Rise time	t_r		-	8.4	-	
Turn-off delay time	$t_{D(OFF)}$		-	39	-	
Fall time	t_f		-	6	-	
Total gate charge	Q_g	$V_{DS} = -15V, I_D = -4A$ $V_{GS} = -10V$	-	6.4	-	nC
Gate-source charge	Q_{gs}		-	2.3	-	
Gate-drain charge	Q_{gd}		-	1.9	-	
DRAIN-SOURCE DIODE CHARACTERISTICS						
Diode forward voltage	V_{SD}	$V_{GS} = 0V, I_S = -4A$	-	-0.81	-1.2	V

TYPICAL OPERATING CHARACTERISTICS

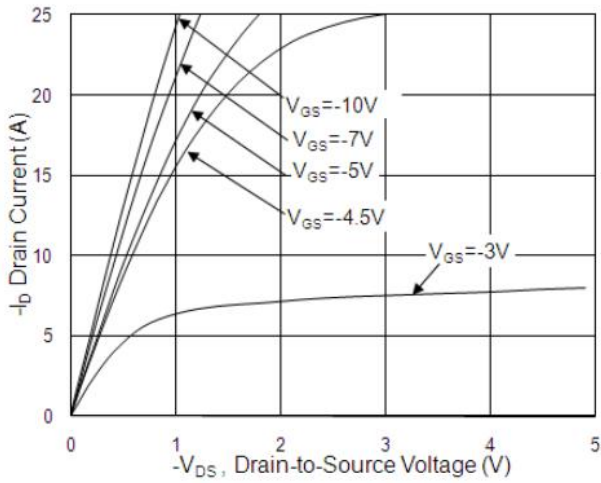

Fig.1 Typical Output Characteristics

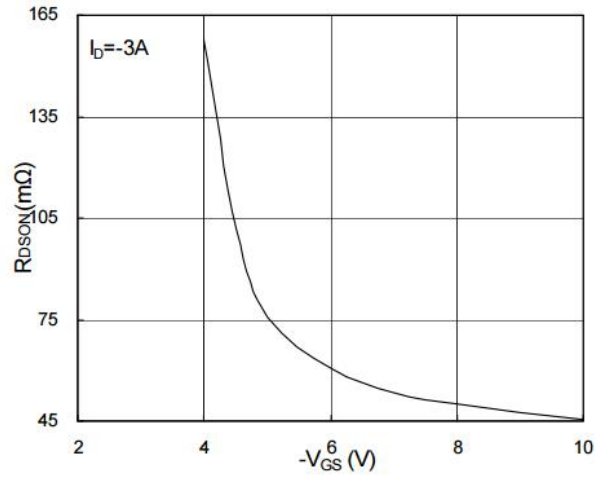

Fig.2 On-Resistance v.s Gate-Source

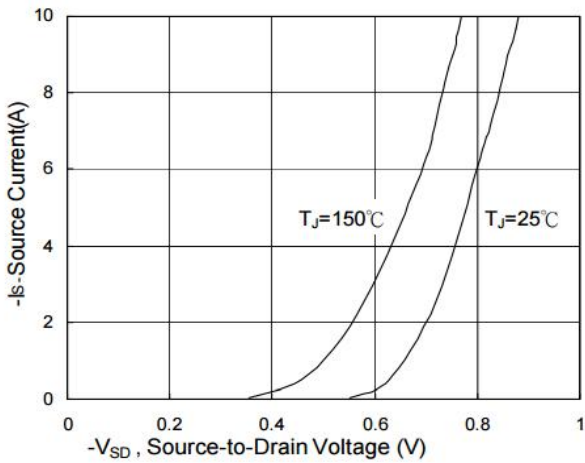

Fig.3 Forward Characteristics of Reverse

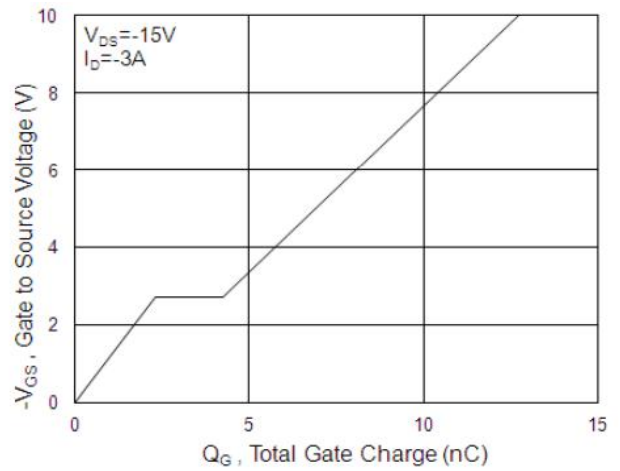

Fig.4 Gate-Charge Characteristics

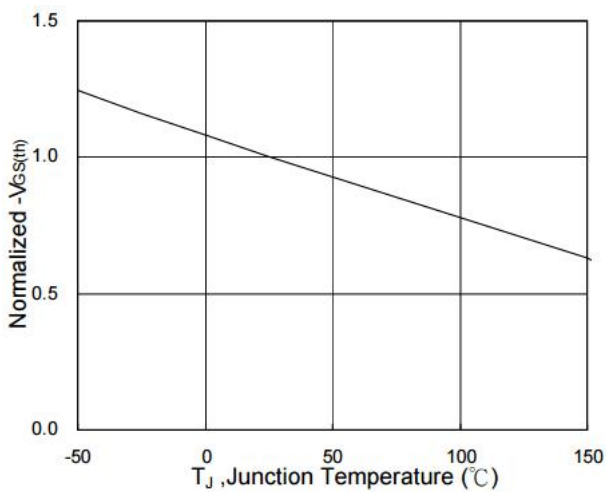

Fig.5 Normalized V_{GS(th)} vs. T_J

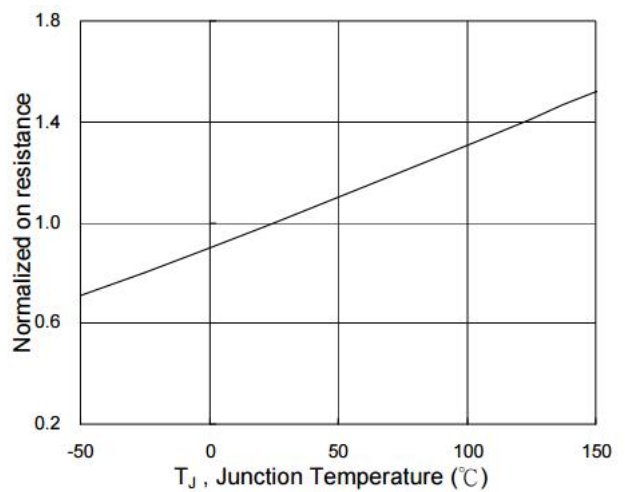

Fig.6 Normalized R_{DS(on)} vs T_J

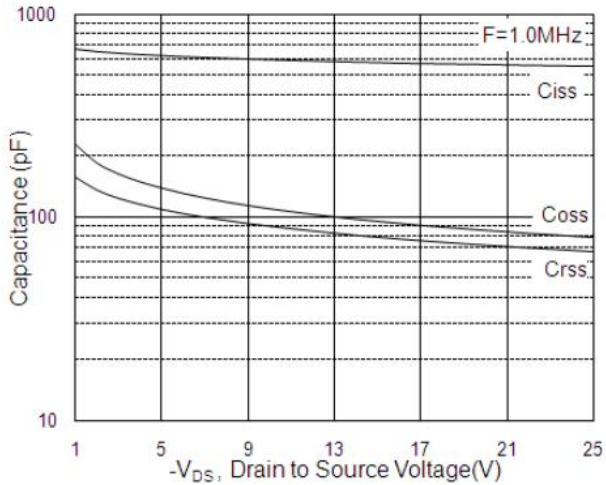

Fig.7 Capacitance

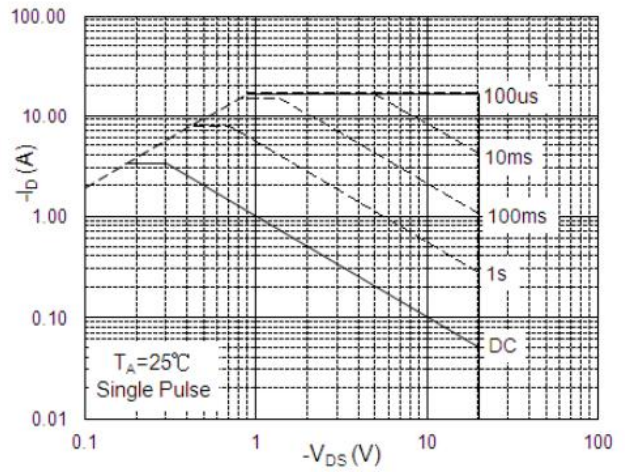

Fig.8 Safe Operating Area

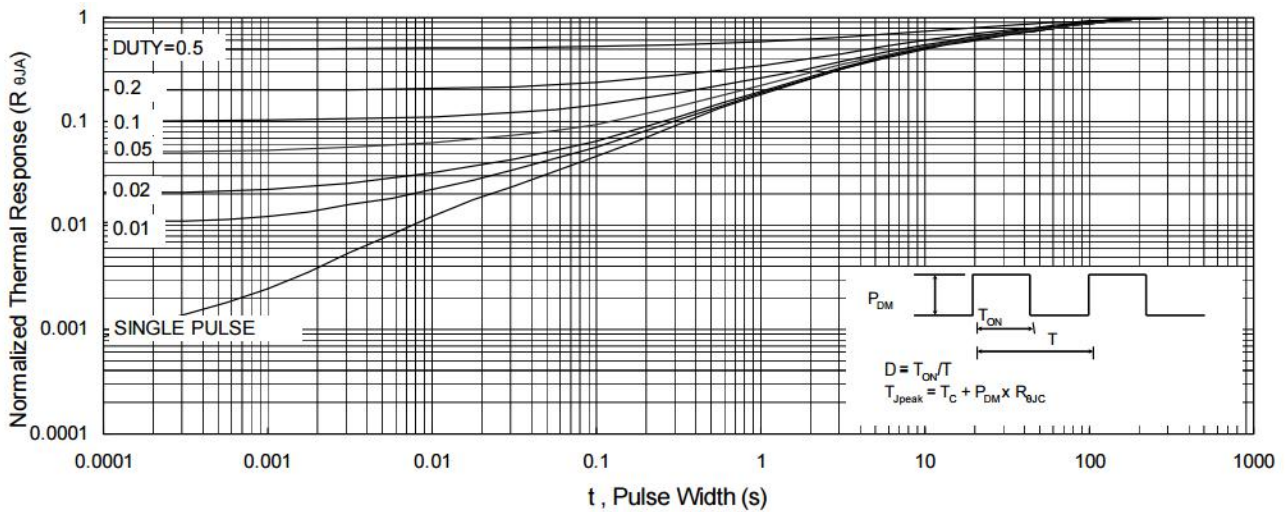
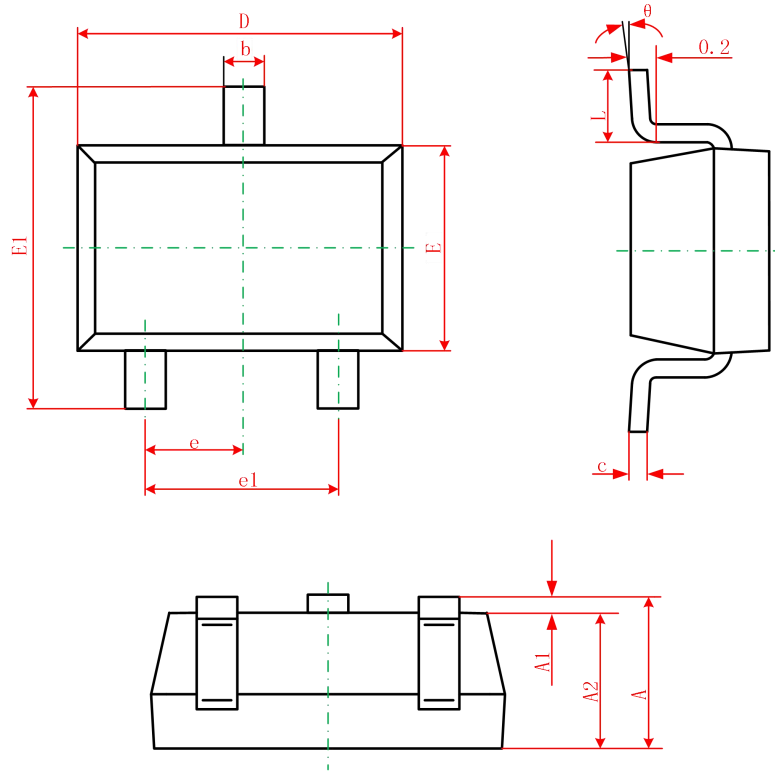

Fig.9 Normalized Maximum Transient Thermal Impedance

PACKAGE INFORMATION

● SOT23-3L

Symbol	Dimensions In Millimeters		Dimensions In Inches	
	Min	Max	Min	Max
A	1.050	1.250	0.041	0.049
A1	0.000	0.100	0.000	0.004
A2	1.050	1.150	0.041	0.045
b	0.300	0.500	0.012	0.020
c	0.100	0.200	0.004	0.008
D	2.820	3.020	0.111	0.119
E	1.500	1.700	0.059	0.067
E1	2.650	2.950	0.104	0.116
e	0.950(BSC)		0.037(BSC)	
e1	1.800	2.000	0.071	0.079
L	0.300	0.600	0.012	0.024
θ	0°	8°	0°	8°

RECOMMENDED MINIMUM PADS FOR SOT23-3L

