

GENERAL DESCRIPTION

The SGM2038 is a low noise, low dropout voltage linear regulator which is designed using CMOS technology. It provides 500mA output current capability. The operating input voltage range is from 0.8V to 5.5V and bias supply voltage range is from 2.5V to 5.5V. The output voltage range is from 0.8V to 3.6V.

Other features include logic-controlled shutdown mode, short-circuit current limit and thermal shutdown protection. The SGM2038 has automatic discharge function to quickly discharge V_{OUT} in the disabled status.

The SGM2038 is suitable for applications which need low noise, fast transient response and low I_Q consumption, such as battery-powered equipment and smartphones, etc.

The SGM2038 is available in a Green UTDFN-1.2x1.2-4L package. It operates over an operating temperature range of -40°C to +125°C.

FEATURES

- **Operating Input Voltage Range: 0.8V to 5.5V**
- **Operating Bias Voltage Range: 2.5V to 5.5V**
- **Fixed Outputs of 0.8V, 0.9V, 1.0V, 1.05V, 1.1V, 1.15V, 1.2V, 1.25V, 1.3V, 1.5V, 1.8V, 2.5V, 2.8V, 3.0V, 3.3V, and 3.6V**
- **500mA Output Current**
- **Output Voltage Accuracy: $\pm 0.8\%$ at +25°C**
- **Very Low Bias Input Current: 37 μ A (TYP)**
- **Very Low Bias Input Current in Shutdown: 0.01 μ A (TYP)**
- **Low Dropout Voltage: 120mV (TYP) at 500mA**
- **Low Noise: 25 μ V_{RMS} (TYP)**
- **Current Limiting and Thermal Protection**
- **Excellent Load and Line Transient Responses**
- **With Output Automatic Discharge**
- **Logic Level Enable Input for ON/OFF Control**
- **-40°C to +125°C Operating Temperature Range**
- **Available in a Green UTDFN-1.2x1.2-4L Package**

APPLICATIONS

- Portable Equipment
- Smartphone
- Industrial and Medical Equipment

TYPICAL APPLICATION

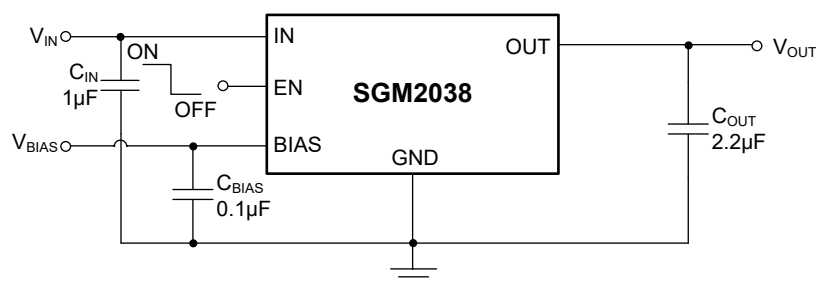

Figure 1. Typical Application Circuit

PACKAGE/ORDERING INFORMATION

| MODEL | PACKAGE DESCRIPTION | SPECIFIED TEMPERATURE RANGE | ORDERING NUMBER | PACKAGE MARKING | PACKING OPTION |
|--------------|---------------------|-----------------------------|-----------------------|-----------------|---------------------|
| SGM2038-0.8 | UTDFN-1.2×1.2-4L | -40°C to +125°C | SGM2038-0.8XUDY4G/TR | 38 XX | Tape and Reel, 5000 |
| SGM2038-0.9 | UTDFN-1.2×1.2-4L | -40°C to +125°C | SGM2038-0.9XUDY4G/TR | 39 XX | Tape and Reel, 5000 |
| SGM2038-1.0 | UTDFN-1.2×1.2-4L | -40°C to +125°C | SGM2038-1.0XUDY4G/TR | 3A XX | Tape and Reel, 5000 |
| SGM2038-1.05 | UTDFN-1.2×1.2-4L | -40°C to +125°C | SGM2038-1.05XUDY4G/TR | 3B XX | Tape and Reel, 5000 |
| SGM2038-1.1 | UTDFN-1.2×1.2-4L | -40°C to +125°C | SGM2038-1.1XUDY4G/TR | 3C XX | Tape and Reel, 5000 |
| SGM2038-1.15 | UTDFN-1.2×1.2-4L | -40°C to +125°C | SGM2038-1.15XUDY4G/TR | 3D XX | Tape and Reel, 5000 |
| SGM2038-1.2 | UTDFN-1.2×1.2-4L | -40°C to +125°C | SGM2038-1.2XUDY4G/TR | 3E XX | Tape and Reel, 5000 |
| SGM2038-1.25 | UTDFN-1.2×1.2-4L | -40°C to +125°C | SGM2038-1.25XUDY4G/TR | 3F XX | Tape and Reel, 5000 |
| SGM2038-1.3 | UTDFN-1.2×1.2-4L | -40°C to +125°C | SGM2038-1.3XUDY4G/TR | 40 XX | Tape and Reel, 5000 |
| SGM2038-1.5 | UTDFN-1.2×1.2-4L | -40°C to +125°C | SGM2038-1.5XUDY4G/TR | 41 XX | Tape and Reel, 5000 |
| SGM2038-1.8 | UTDFN-1.2×1.2-4L | -40°C to +125°C | SGM2038-1.8XUDY4G/TR | 42 XX | Tape and Reel, 5000 |
| SGM2038-2.5 | UTDFN-1.2×1.2-4L | -40°C to +125°C | SGM2038-2.5XUDY4G/TR | 43 XX | Tape and Reel, 5000 |
| SGM2038-2.8 | UTDFN-1.2×1.2-4L | -40°C to +125°C | SGM2038-2.8XUDY4G/TR | 44 XX | Tape and Reel, 5000 |
| SGM2038-3.0 | UTDFN-1.2×1.2-4L | -40°C to +125°C | SGM2038-3.0XUDY4G/TR | 45 XX | Tape and Reel, 5000 |
| SGM2038-3.3 | UTDFN-1.2×1.2-4L | -40°C to +125°C | SGM2038-3.3XUDY4G/TR | 46 XX | Tape and Reel, 5000 |
| SGM2038-3.6 | UTDFN-1.2×1.2-4L | -40°C to +125°C | SGM2038-3.6XUDY4G/TR | 48 XX | Tape and Reel, 5000 |

MARKING INFORMATION

NOTE: XX = Date Code.

YY — Serial Number
XX
├── Date Code - Month
└── Date Code - Year

Green (RoHS & HSF): SG Micro Corp defines "Green" to mean Pb-Free (RoHS compatible) and free of halogen substances. If you have additional comments or questions, please contact your SGMICRO representative directly.

ABSOLUTE MAXIMUM RATINGS

| | |
|--|--|
| IN, BIAS, EN to GND | -0.3V to 6V |
| OUT to GND | -0.3V to MIN((V _{IN} + 0.3V), 6V) |
| Power Dissipation, P _D @ T _A = +25°C | |
| UTDFN-1.2×1.2-4L | 600mW |
| Package Thermal Resistance | |
| UTDFN-1.2×1.2-4L, θ _{JA} | 208°C/W |
| Junction Temperature | +150°C |
| Storage Temperature Range..... | -65°C to +150°C |
| Lead Temperature (Soldering, 10s) | +260°C |
| ESD Susceptibility | |
| HBM..... | 8000V |
| MM..... | 400V |
| CDM | 1000V |

RECOMMENDED OPERATING CONDITIONS

| | |
|--|-----------------|
| Operating Input Voltage Range | 0.8V to 5.5V |
| Operating Bias Voltage Range | 2.5V to 5.5V |
| Enable Input Voltage Range | 0V to 5.5V |
| BIAS Effective Capacitance, C _{BIAS} | 0.05μF (MIN) |
| Input Effective Capacitance, C _{IN} | 0.5μF (MIN) |
| Output Effective Capacitance, C _{OUT} | 1μF to 100μF |
| Operating Temperature Range | -40°C to +125°C |

OVERSTRESS CAUTION

Stresses beyond those listed in Absolute Maximum Ratings may cause permanent damage to the device. Exposure to absolute maximum rating conditions for extended periods may affect reliability. Functional operation of the device at any conditions beyond those indicated in the Recommended Operating Conditions section is not implied.

ESD SENSITIVITY CAUTION

This integrated circuit can be damaged if ESD protections are not considered carefully. SGMICRO recommends that all integrated circuits be handled with appropriate precautions. Failure to observe proper handling and installation procedures can cause damage. ESD damage can range from subtle performance degradation to complete device failure. Precision integrated circuits may be more susceptible to damage because even small parametric changes could cause the device not to meet the published specifications.

DISCLAIMER

SG Micro Corp reserves the right to make any change in circuit design, or specifications without prior notice.

PIN CONFIGURATION

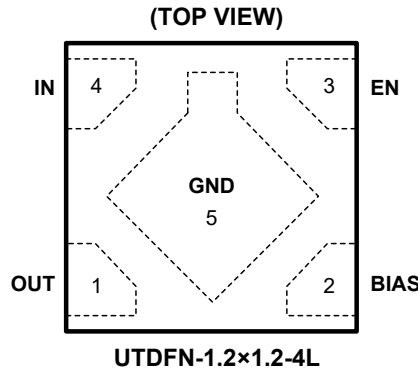

PIN DESCRIPTION

| PIN | NAME | FUNCTION |
|-----|------|--|
| 1 | OUT | Regulated Output Voltage Pin. It is recommended to use a ceramic capacitor with effective capacitance in the range of 1µF to 100µF to ensure stability. This ceramic capacitor should be placed as close as possible to OUT pin. |
| 2 | BIAS | Bias Voltage Supply for Internal Control Circuits. This pin is monitored by internal under-voltage lockout circuit. |
| 3 | EN | Enable Pin. Drive EN high to turn on the regulator. Drive EN low to turn off the regulator. The EN pin has an internal pull-down resistance which ensures that the device is turned off when the EN pin is floated. |
| 4 | IN | Input Supply Voltage Pin. It is recommended to use a 1µF or larger ceramic capacitor from IN pin to ground to get good power supply decoupling. This ceramic capacitor should be placed as close as possible to IN pin. |
| 5 | GND | Ground. |

ELECTRICAL CHARACTERISTICS

($V_{BIAS} = 2.7V$ or ($V_{OUT(NOM)} + 1.6V$) (whichever is greater), $V_{EN} = V_{BIAS}$, $V_{IN} = V_{OUT(NOM)} + 0.3V$, $I_{OUT} = 1mA$, $C_{IN} = 1\mu F$, $C_{BIAS} = 0.1\mu F$, $C_{OUT} = 2.2\mu F$, Full = $-40^{\circ}C$ to $+125^{\circ}C$, unless otherwise noted.)

| PARAMETER | SYMBOL | CONDITIONS | TEMP | MIN | TYP | MAX | UNITS |
|--|---|---|----------------|---------------------------------|-------|------|---------------|
| Operating Input Voltage Range | V_{IN} | | $+25^{\circ}C$ | $V_{OUT(NOM)} + V_{DRO_IN}$ | | 5.5 | V |
| Operating Bias Voltage Range | V_{BIAS} | | $+25^{\circ}C$ | $(V_{OUT(NOM)} + 1.4) \geq 2.5$ | | 5.5 | V |
| Under-Voltage Lockout Threshold | V_{UVLO} | V_{BIAS} rising | $+25^{\circ}C$ | | 1.6 | | V |
| | | Hysteresis | $+25^{\circ}C$ | | 0.2 | | |
| Output Voltage Accuracy | V_{OUT} | $V_{IN} = (V_{OUT(NOM)} + 0.3V)$ to $(V_{OUT(NOM)} + 1.0V)$, $V_{BIAS} = 2.7V$ or $(V_{OUT(NOM)} + 1.6V)$ to $5.5V$, $I_{OUT} = 1mA$ to $500mA$ | $+25^{\circ}C$ | -0.8 | | 0.8 | % |
| | | | Full | -1.5 | | 1.5 | |
| V_{IN} Line Regulation | $\frac{\Delta V_{OUT}}{\Delta V_{IN} \times V_{OUT}}$ | $V_{IN} = (V_{OUT(NOM)} + 0.3V)$ to $5.5V$ | $+25^{\circ}C$ | | 0.002 | 0.03 | %/V |
| V_{BIAS} Line Regulation | $\frac{\Delta V_{OUT}}{\Delta V_{BIAS} \times V_{OUT}}$ | $V_{BIAS} = 2.7V$ or $(V_{OUT(NOM)} + 1.6V)$ to $5.5V$, $0.8V \leq V_{OUT(NOM)} \leq 1.8V$ | $+25^{\circ}C$ | | 0.002 | 0.03 | %/V |
| | | $V_{BIAS} = (V_{OUT(NOM)} + 1.6V)$ to $5.5V$, $1.8V < V_{OUT(NOM)} \leq 3.6V$ | $+25^{\circ}C$ | | 0.005 | 0.1 | |
| Load Regulation | ΔV_{OUT} | $I_{OUT} = 1mA$ to $500mA$, $0.8V \leq V_{OUT(NOM)} \leq 1.8V$ | $+25^{\circ}C$ | | 0.5 | 2 | mV |
| | | $I_{OUT} = 1mA$ to $500mA$, $1.8V < V_{OUT(NOM)} \leq 3.6V$ | $+25^{\circ}C$ | | 1 | 5 | |
| V_{IN} Dropout Voltage ⁽¹⁾ | V_{DRO_IN} | $I_{OUT} = 150mA$ | $+25^{\circ}C$ | | 35 | 50 | mV |
| | | $I_{OUT} = 500mA$ | $+25^{\circ}C$ | | 120 | 170 | |
| V_{BIAS} Dropout Voltage ⁽²⁾⁽³⁾ | V_{DRO_BIAS} | $I_{OUT} = 500mA$ | $+25^{\circ}C$ | | 1.2 | 1.5 | V |
| Output Current Limit | I_{LIMIT} | | $+25^{\circ}C$ | 505 | 670 | | mA |
| Short Current Limit | I_{SHORT} | $V_{OUT} = 0V$ | $+25^{\circ}C$ | | 340 | | mA |
| BIAS Pin Operating Current | I_{BIAS} | $V_{BIAS} = 5.5V$ | $+25^{\circ}C$ | | 37 | 53 | μA |
| | | | Full | | | 55 | |
| IN Pin Disable Current | I_{DIS_IN} | $V_{EN} = 0V$ | $+25^{\circ}C$ | | 0.1 | 0.5 | μA |
| | | | Full | | | 1.6 | |
| BIAS Pin Disable Current | I_{DIS_BIAS} | $V_{EN} = 0V$ | $+25^{\circ}C$ | | 0.01 | 0.5 | μA |
| | | | Full | | | 2.5 | |
| EN Pin Threshold Voltage | V_{IH} | EN input voltage high | Full | 1.2 | | | V |
| | V_{IL} | EN input voltage low | Full | | | 0.25 | V |
| EN Pin Pull-Down Resistance | R_{EN} | | $+25^{\circ}C$ | | 580 | | k Ω |
| Turn-On Time | t_{ON} | From assertion of V_{EN} to $V_{OUT} = 90\%V_{OUT(NOM)}$ | $+25^{\circ}C$ | | 100 | | μs |
| V_{IN} Power Supply Rejection Ratio | PSRR | V_{IN} to V_{OUT} , $f = 1kHz$, $V_{OUT(NOM)} = 1.0V$, $I_{OUT} = 150mA$, $V_{IN} \geq 1.5V$ | $+25^{\circ}C$ | | 71 | | dB |
| V_{BIAS} Power Supply Rejection Ratio | | V_{BIAS} to V_{OUT} , $f = 1kHz$, $V_{OUT(NOM)} = 1.0V$, $I_{OUT} = 150mA$, $V_{IN} \geq 1.5V$ | $+25^{\circ}C$ | | 76 | | |
| Output Voltage Noise | e_n | $V_{IN} = V_{OUT(NOM)} + 0.5V$, $V_{OUT(NOM)} = 1.0V$, $f = 10Hz$ to $100kHz$ | $+25^{\circ}C$ | | 25 | | μV_{RMS} |
| Output Discharge Resistance | R_{DIS} | $V_{EN} = 0V$, $V_{OUT} = 0.5V$ | $+25^{\circ}C$ | | 120 | | Ω |
| Thermal Shutdown Temperature | T_{SHDN} | | | | 160 | | $^{\circ}C$ |
| Thermal Shutdown Hysteresis | ΔT_{SHDN} | | | | 20 | | $^{\circ}C$ |

NOTES:

- V_{IN} dropout voltage is defined as the difference between V_{IN} and V_{OUT} when V_{OUT} falls to $95\% \times V_{OUT(NOM)}$.
- V_{BIAS} dropout voltage refers to $V_{BIAS} - V_{OUT}$ when the V_{IN} and $BIAS$ pins are connected together and V_{OUT} falls to $95\% \times V_{OUT(NOM)}$.
- For output voltages lower than $1.5V$, V_{BIAS} dropout voltage is not applicable because the minimum bias supply voltage is $2.5V$.

TYPICAL PERFORMANCE CHARACTERISTICS

$T_A = +25^\circ\text{C}$, $V_{IN} = 1.3\text{V}$, $V_{EN} = V_{BIAS} = 2.7\text{V}$, $V_{OUT(NOM)} = 1.0\text{V}$, $C_{IN} = 1\mu\text{F}$, $C_{BIAS} = 0.1\mu\text{F}$, $C_{OUT} = 2.2\mu\text{F}$, unless otherwise noted.

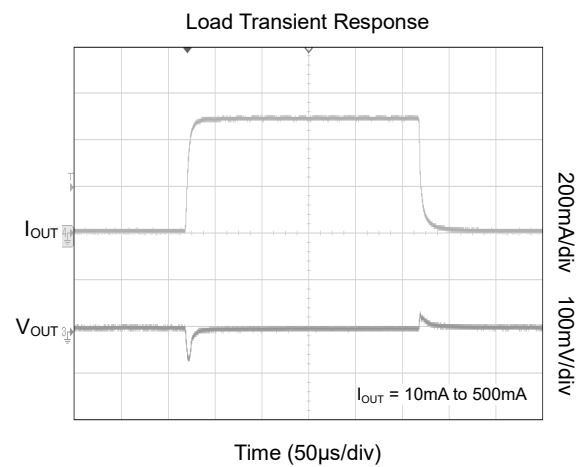
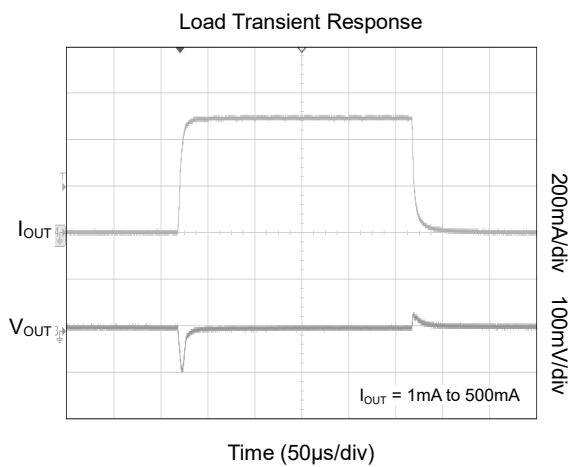
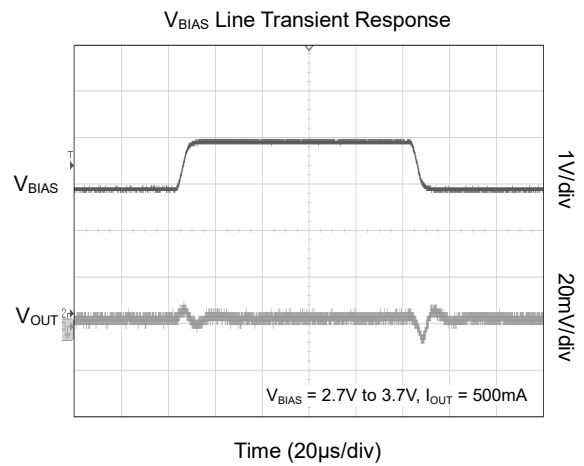
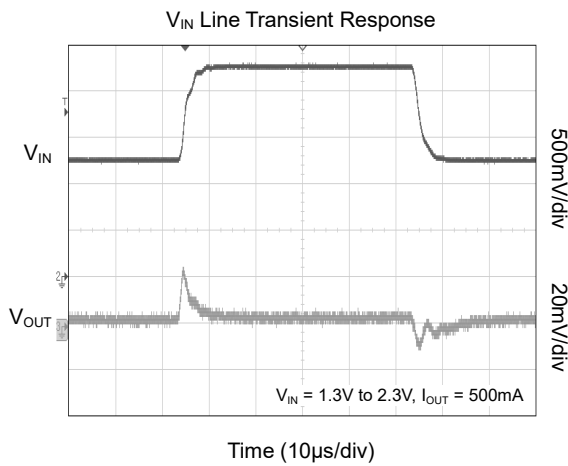
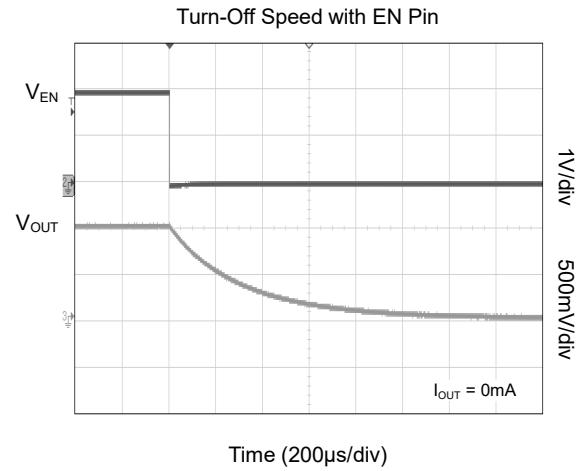
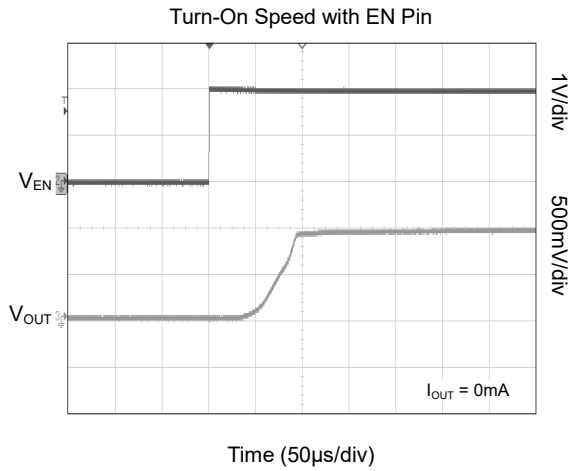

TYPICAL PERFORMANCE CHARACTERISTICS (continued)

$T_A = +25^\circ\text{C}$, $V_{IN} = 1.3\text{V}$, $V_{EN} = V_{BIAS} = 2.7\text{V}$, $V_{OUT(NOM)} = 1.0\text{V}$, $C_{IN} = 1\mu\text{F}$, $C_{BIAS} = 0.1\mu\text{F}$, $C_{OUT} = 2.2\mu\text{F}$, unless otherwise noted.

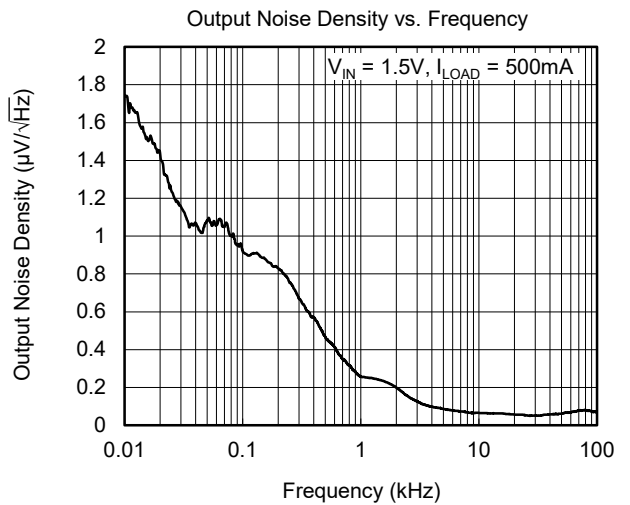
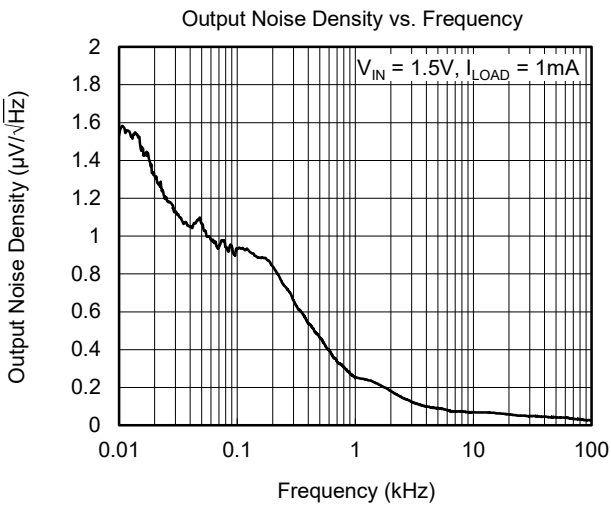
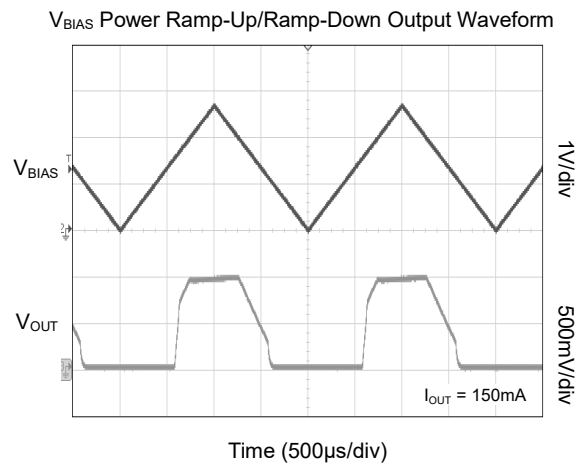
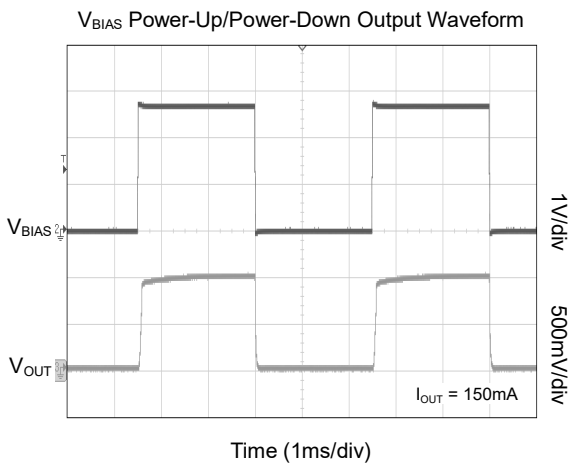
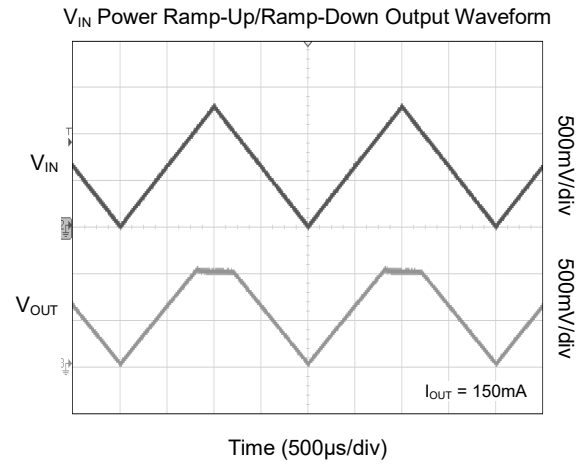
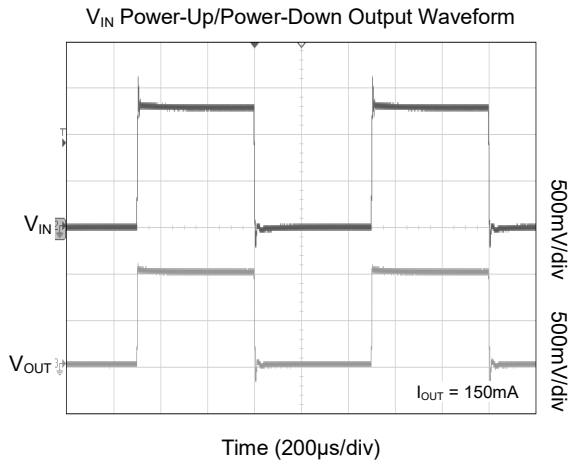

TYPICAL PERFORMANCE CHARACTERISTICS (continued)

$T_A = +25^\circ\text{C}$, $V_{IN} = 1.3\text{V}$, $V_{EN} = V_{BIAS} = 2.7\text{V}$, $V_{OUT(NOM)} = 1.0\text{V}$, $C_{IN} = 1\mu\text{F}$, $C_{BIAS} = 0.1\mu\text{F}$, $C_{OUT} = 2.2\mu\text{F}$, unless otherwise noted.

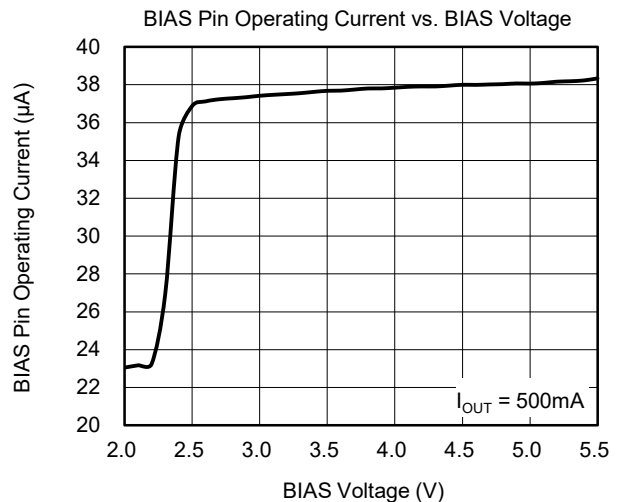
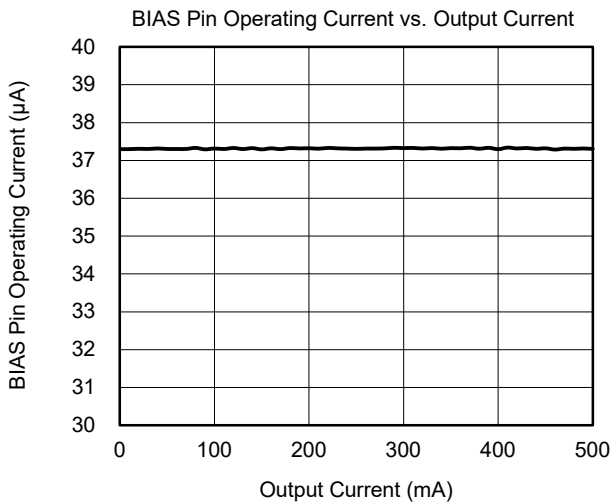
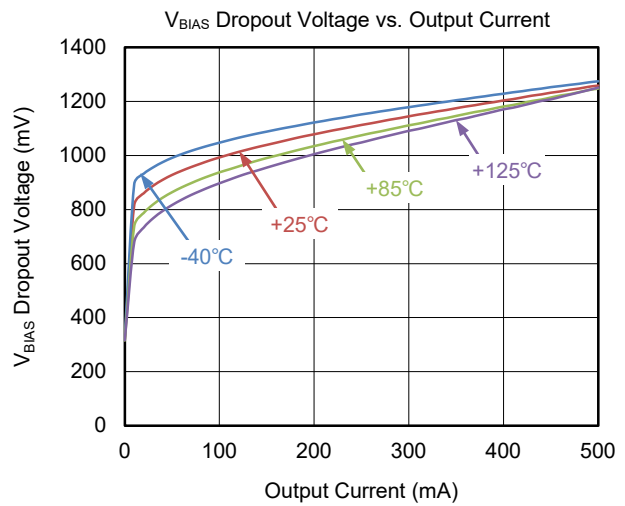
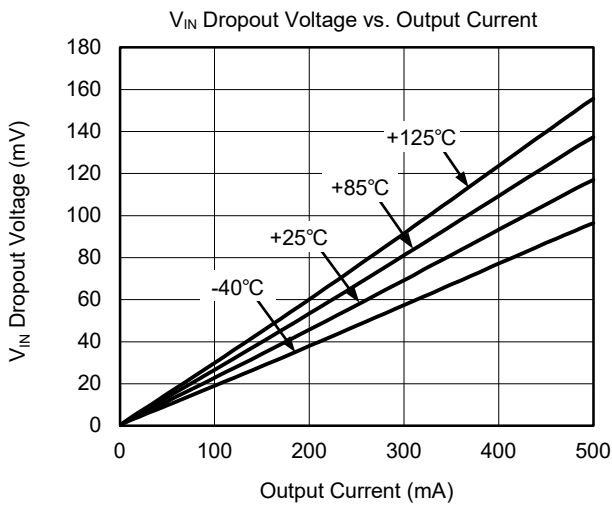
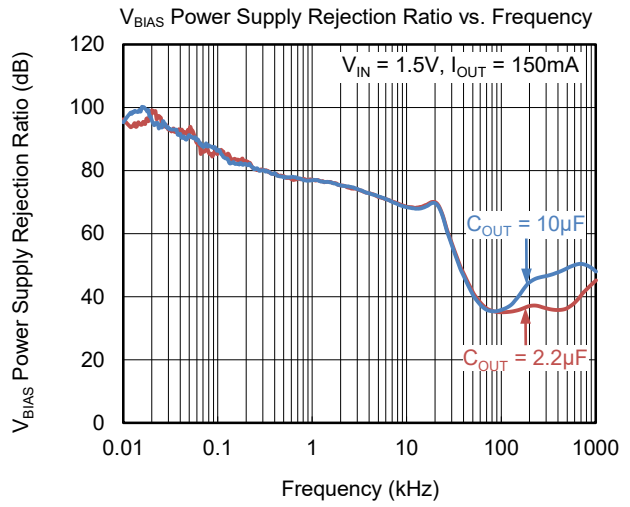
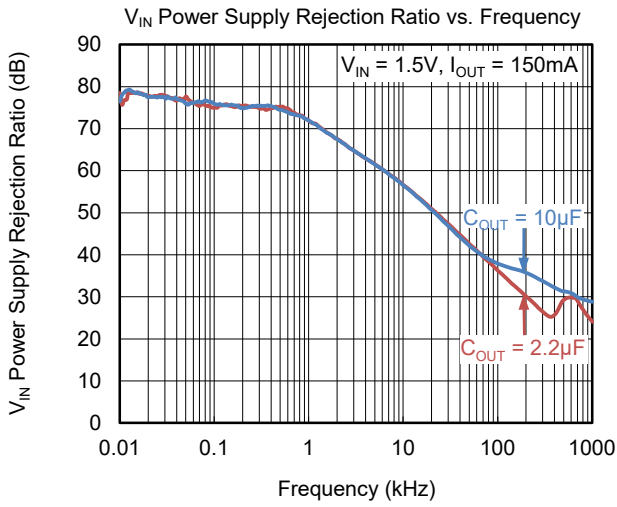

TYPICAL PERFORMANCE CHARACTERISTICS (continued)

T_A = +25°C, V_{IN} = 1.3V, V_{EN} = V_{BIAS} = 2.7V, V_{OUT(NOM)} = 1.0V, C_{IN} = 1μF, C_{BIAS} = 0.1μF, C_{OUT} = 2.2μF, unless otherwise noted.

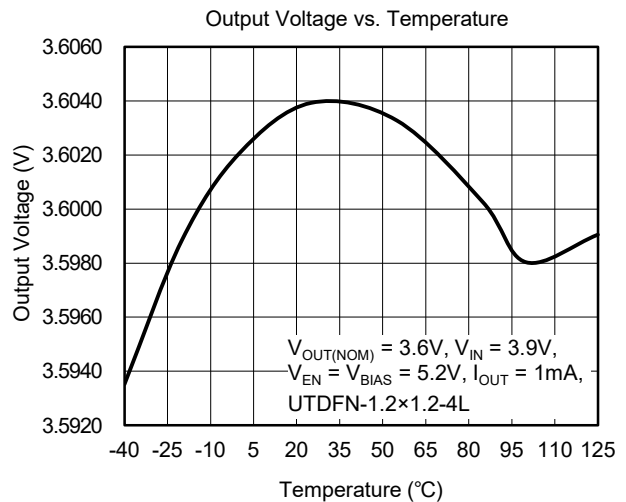
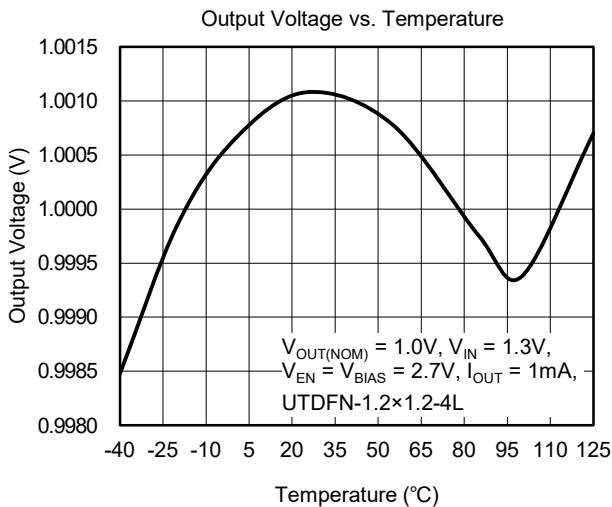
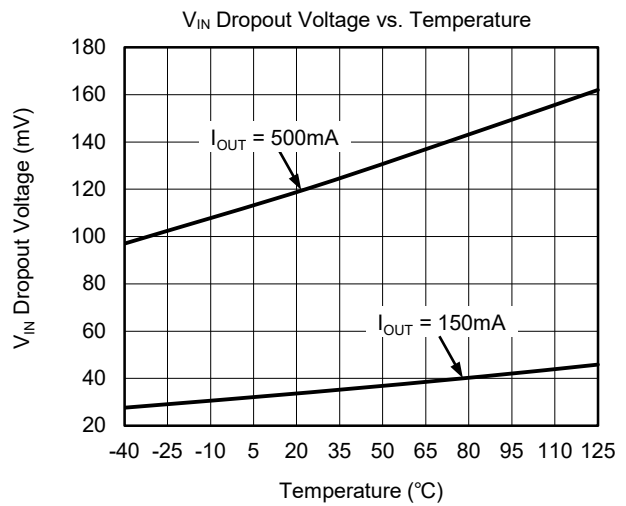
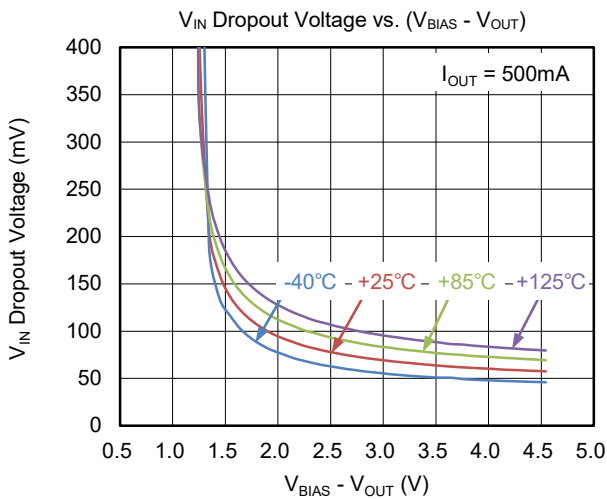
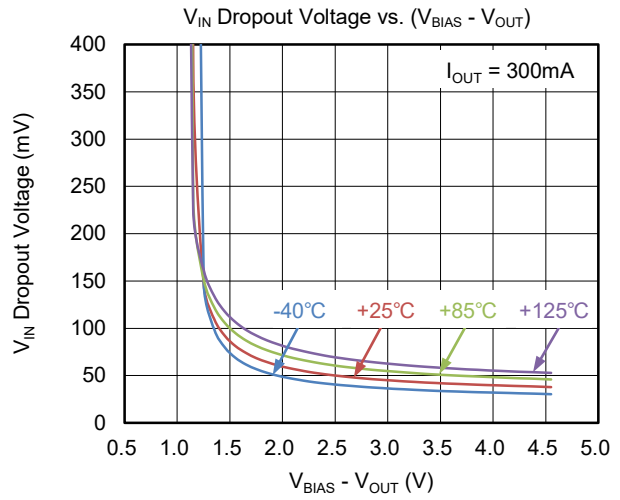
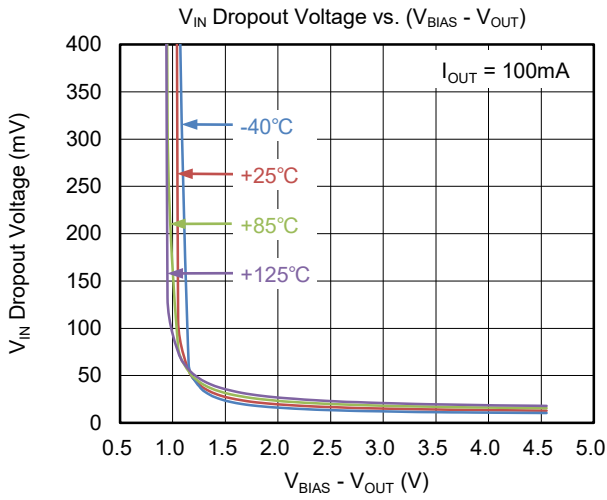

FUNCTIONAL BLOCK DIAGRAM

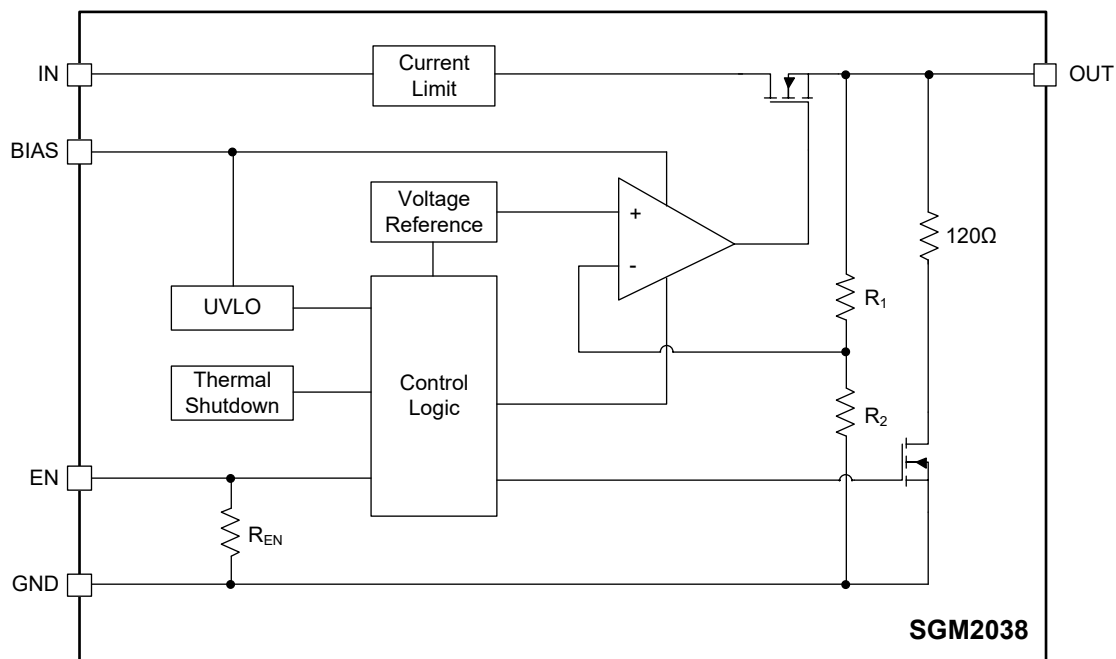

Figure 2. Block Diagram

APPLICATION INFORMATION

The SGM2038 is a low noise high performance LDO with fast transient response. It consumes only 37 μ A (TYP) quiescent current and provides 500mA output current. The SGM2038 provides protection functions for output overload, output short-circuit condition and overheating.

The SGM2038 is suitable for applications which need noise sensitive circuit such as battery-powered equipment and smartphones.

Input and Bias Capacitors (C_{IN} , C_{BIAS})

The input decoupling capacitor and bias capacitor should be placed as close as possible to the IN pin and BIAS pin for ensuring the device stability. $C_{IN} = 1\mu\text{F}/C_{BIAS} = 0.1\mu\text{F}$ or larger X7R or X5R ceramic capacitors are selected to get good dynamic performance.

When V_{IN} is required to provide large current instantaneously, a large effective input capacitor is required. Multiple input capacitors can limit the input tracking inductance. Adding more input capacitors is available to restrict the ringing and to keep it below the device absolute maximum ratings.

Output Capacitor (C_{OUT})

The output capacitor should be placed as close as possible to the OUT pin. 2.2 μ F or larger X7R or X5R ceramic capacitor is selected to get good dynamic performance. The minimum effective capacitance of C_{OUT} that SGM2038 can remain stable is 1 μ F. For ceramic capacitor, temperature, DC bias and package size will change the effective capacitance, so enough margin of C_{OUT} must be considered in design. Additionally, C_{OUT} with larger capacitance and lower ESR will help increase the high frequency PSRR and improve the load transient response.

Enable Operation

The EN pin of the SGM2038 is used to enable/disable the device and to deactivate/activate the output automatic discharge function.

When the EN pin voltage is lower than 0.25V, the device is in shutdown state, and there is no current flowing from IN to OUT pin. In this state, the automatic

discharge transistor is active to discharge the output voltage through a 120 Ω (TYP) resistor.

When the EN pin voltage is higher than 1.2V, the device is in active state. The input voltage is regulated to the output voltage and the automatic discharge transistor is turned off.

Dropout Voltage

The SGM2038 specifies two dropout voltages because there are two power supplies V_{IN} and V_{BIAS} and one V_{OUT} regulator output. V_{IN} dropout voltage is defined as the difference between V_{IN} and V_{OUT} when V_{OUT} falls 5% below $V_{OUT(NOM)}$. When the output voltage is lower than 1.5V, V_{BIAS} dropout voltage is not applicable because the minimum bias operating voltage is 2.5V.

When V_{OUT} begins to decrease and V_{BIAS} is high enough, the V_{IN} dropout voltage equals to $V_{IN} - V_{OUT}$. V_{BIAS} dropout voltage refers to $V_{BIAS} - V_{OUT}$ when the IN and BIAS pins are connected together and V_{OUT} begins to decrease.

Reverse Current Protection

The NMOS power transistor has an inherent body diode, this body diode will be forward biased when $V_{OUT} > V_{IN}$. When $V_{OUT} > V_{IN}$, the reverse current flowing from the OUT pin to the IN pin will damage the SGM2038. If $V_{OUT} > (V_{IN} + 0.3\text{V})$ is expected in the application, one external Schottky diode will be added between the OUT pin and IN pin to protect the SGM2038.

Negatively Biased Output

When the output voltage is negative, the chip may not start up due to parasitic effects. Ensure that the output is greater than -0.3V under all conditions. If negatively biased output is excessive and expected in the application, a Schottky diode can be added between the OUT pin and GND pin.

Output Current Limit and Short-Circuit Protection

When an overload event happens, the output current is internally limited to 670mA (TYP). When the OUT pin is shorted to ground, the short-circuit protection will limit the output current to 340mA (TYP).

APPLICATION INFORMATION (continued)

Thermal Shutdown

The SGM2038 can detect the temperature of die. When the die temperature exceeds the threshold value of thermal shutdown, the SGM2038 will be in shutdown state and it will remain in this state until the die temperature decreases to +140°C.

Power Dissipation (P_D)

Thermal protection limits power dissipation in the SGM2038. When power dissipation on pass element (P_D = (V_{IN} - V_{OUT}) × I_{OUT}) is too much and the operating junction temperature exceeds +160°C, the OTP circuit starts the thermal shutdown function and turns the pass element off. The power dissipation needs to be less than 1.5W when thermal protection occurs.

Therefore, thermal analysis for the chosen application is important to guarantee reliable performance over all conditions. To guarantee reliable operation, the junction temperature of the SGM2038 must not exceed +125°C.

The maximum allowable power dissipation depends on the thermal resistance of the IC package, the PCB layout, the rate of surrounding airflow, and the difference between the junction temperature and ambient temperature. The maximum power dissipation can be approximated using the following equation:

$$P_{D(MAX)} = (T_{J(MAX)} - T_A) / \theta_{JA} \quad (1)$$

where T_{J(MAX)} is the maximum junction temperature, T_A is the ambient temperature, and θ_{JA} is the junction -to-ambient thermal resistance.

REVISION HISTORY

NOTE: Page numbers for previous revisions may differ from page numbers in the current version.

| JULY 2022 – REV.A to REV.A.1 | Page |
|---|------|
| Updated Recommended Operating Conditions | 3 |
| <hr/> | |
| Changes from Original (SEPTEMBER 2018) to REV.A | Page |
| Changed from product preview to production data | All |

PACKAGE OUTLINE DIMENSIONS

UTDFN-1.2x1.2-4L

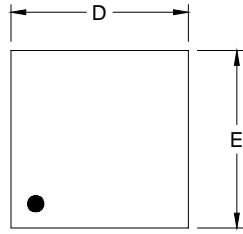

TOP VIEW

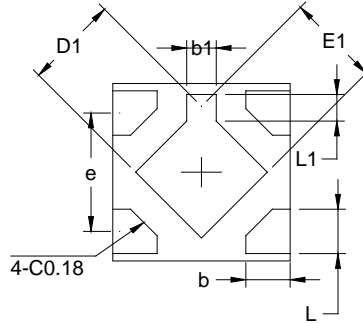

BOTTOM VIEW

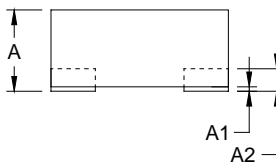

SIDE VIEW

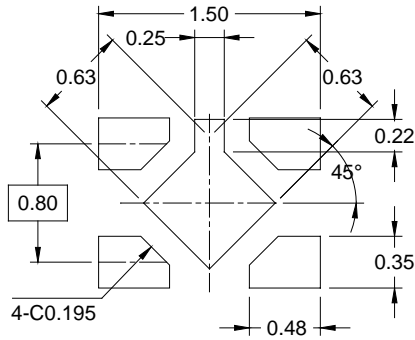

RECOMMENDED LAND PATTERN (Unit: mm)

| Symbol | Dimensions In Millimeters | | |
|--------|---------------------------|-------|-------|
| | MIN | MOD | MAX |
| A | 0.500 | 0.550 | 0.600 |
| A1 | | | 0.050 |
| A2 | 0.152 REF | | |
| e | 0.800 BSC | | |
| D | 1.150 | 1.200 | 1.250 |
| E | 1.150 | 1.200 | 1.250 |
| D1 | 0.580 | 0.630 | 0.680 |
| E1 | 0.580 | 0.630 | 0.680 |
| b | 0.250 | 0.300 | 0.350 |
| b1 | 0.150 | 0.200 | 0.250 |
| L | 0.250 | 0.300 | 0.350 |
| L1 | 0.130 | 0.180 | 0.230 |

NOTE: This drawing is subject to change without notice.

PACKAGE INFORMATION

TAPE AND REEL INFORMATION

REEL DIMENSIONS



TAPE DIMENSIONS



NOTE: The picture is only for reference. Please make the object as the standard.

KEY PARAMETER LIST OF TAPE AND REEL

| Package Type | Reel Diameter | Reel Width W1 (mm) | A0 (mm) | B0 (mm) | K0 (mm) | P0 (mm) | P1 (mm) | P2 (mm) | W (mm) | Pin1 Quadrant |
|------------------|---------------|--------------------|---------|---------|---------|---------|---------|---------|--------|---------------|
| UTDFN-1.2×1.2-4L | 7" | 9.0 | 1.35 | 1.35 | 0.73 | 4.0 | 4.0 | 2.0 | 8.0 | Q1 |

000001

PACKAGE INFORMATION

CARTON BOX DIMENSIONS



NOTE: The picture is only for reference. Please make the object as the standard.

KEY PARAMETER LIST OF CARTON BOX

| Reel Type | Length (mm) | Width (mm) | Height (mm) | Pizza/Carton |
|-------------|-------------|------------|-------------|--------------|
| 7" (Option) | 368 | 227 | 224 | 8 |
| 7" | 442 | 410 | 224 | 18 |

DD0002