



# SGM2036 300mA, Low Power and Low Dropout RF Linear Regulator

## GENERAL DESCRIPTION

The SGM2036 is a low noise, low voltage and low dropout voltage linear regulator. It is capable of supplying 300mA output current with typical dropout voltage of only 165mV. The operating input voltage range is from 1.6V to 5.5V. The output voltage range is from 0.8V to 5.0V in fixed output version. For adjustable output version, the output voltage can be adjusted from 0.8V to 5.0V by using external resistors.

Other features include logic-controlled shutdown mode, short-circuit current limit and thermal shutdown protection. The SGM2036 has automatic discharge function to quickly discharge  $V_{OUT}$  in the disabled status.

The SGM2036 is available in Green UTDFN-1×1-4L, SOT-23-5 and SC70-5 packages. It operates over an operating temperature range of -40°C to +85°C.

## FEATURES

- **Operating Input Voltage Range: 1.6V to 5.5V**
- **Fixed Output Voltages: 0.8V, 0.9V, 1.0V, 1.05V, 1.1V, 1.2V, 1.3V, 1.35V, 1.5V, 1.8V, 1.85V, 2.1V, 2.2V, 2.3V, 2.5V, 2.6V, 2.7V, 2.8V, 2.85V, 2.9V, 3.0V, 3.1V, 3.3V, 3.6V, 4.2V, 4.4V and 5.0V**
- **Adjustable Output from 0.8V to 5.0V**
- **300mA Guaranteed Output Current**
- **Output Voltage Accuracy:  $\pm 2.5\%$  at +25°C**
- **Low Dropout Voltage: 165mV (TYP) at 300mA**
- **Low Supply Current: 20 $\mu$ A (TYP)**
- **Shutdown Supply Current: 0.01 $\mu$ A (TYP)**
- **Short Start-Up Time**
- **Short Auto-Discharge Function**
- **Thermal Shutdown Protection**
- **Short-Circuit Current Limit**
- **-40°C to +85°C Operating Temperature Range**
- **Available in Green UTDFN-1×1-4L, SOT-23-5 and SC70-5 Packages**

## APPLICATIONS

Modems  
Cellular Telephones  
PCMCIA Cards  
Palmtop Computers  
Portable Electronics

## PACKAGE/ORDERING INFORMATION

MODEL	PACKAGE DESCRIPTION	SPECIFIED TEMPERATURE RANGE	ORDERING NUMBER	PACKAGE MARKING	PACKING OPTION
SGM2036-0.8	UTDFN-1×1-4L	-40°C to +85°C	SGM2036-0.8YUDH4G/TR	SF	Tape and Reel, 10000
SGM2036-0.9	UTDFN-1×1-4L	-40°C to +85°C	SGM2036-0.9YUDH4G/TR	NE	Tape and Reel, 10000
SGM2036-1.0	UTDFN-1×1-4L	-40°C to +85°C	SGM2036-1.0YUDH4G/TR	J3	Tape and Reel, 10000
SGM2036-1.05	UTDFN-1×1-4L	-40°C to +85°C	SGM2036-1.05YUDH4G/TR	NF	Tape and Reel, 10000
SGM2036-1.1	UTDFN-1×1-4L	-40°C to +85°C	SGM2036-1.1YUDH4G/TR	O0	Tape and Reel, 10000
SGM2036-1.2	UTDFN-1×1-4L	-40°C to +85°C	SGM2036-1.2YUDH4G/TR	HE	Tape and Reel, 10000
SGM2036-1.3	UTDFN-1×1-4L	-40°C to +85°C	SGM2036-1.3YUDH4G/TR	O1	Tape and Reel, 10000
SGM2036-1.35	UTDFN-1×1-4L	-40°C to +85°C	SGM2036-1.35YUDH4G/TR	Z7	Tape and Reel, 10000
SGM2036-1.5	UTDFN-1×1-4L	-40°C to +85°C	SGM2036-1.5YUDH4G/TR	HF	Tape and Reel, 10000
SGM2036-1.8	UTDFN-1×1-4L	-40°C to +85°C	SGM2036-1.8YUDH4G/TR	I0	Tape and Reel, 10000
SGM2036-1.85	UTDFN-1×1-4L	-40°C to +85°C	SGM2036-1.85YUDH4G/TR	O2	Tape and Reel, 10000
SGM2036-2.1	UTDFN-1×1-4L	-40°C to +85°C	SGM2036-2.1YUDH4G/TR	O3	Tape and Reel, 10000
SGM2036-2.2	UTDFN-1×1-4L	-40°C to +85°C	SGM2036-2.2YUDH4G/TR	O4	Tape and Reel, 10000
SGM2036-2.3	UTDFN-1×1-4L	-40°C to +85°C	SGM2036-2.3YUDH4G/TR	SA	Tape and Reel, 10000
SGM2036-2.5	UTDFN-1×1-4L	-40°C to +85°C	SGM2036-2.5YUDH4G/TR	O5	Tape and Reel, 10000
SGM2036-2.6	UTDFN-1×1-4L	-40°C to +85°C	SGM2036-2.6YUDH4G/TR	N6	Tape and Reel, 10000
SGM2036-2.7	UTDFN-1×1-4L	-40°C to +85°C	SGM2036-2.7YUDH4G/TR	O6	Tape and Reel, 10000
SGM2036-2.8	UTDFN-1×1-4L	-40°C to +85°C	SGM2036-2.8YUDH4G/TR	I1	Tape and Reel, 10000
SGM2036-2.85	UTDFN-1×1-4L	-40°C to +85°C	SGM2036-2.85YUDH4G/TR	O7	Tape and Reel, 10000
SGM2036-2.9	UTDFN-1×1-4L	-40°C to +85°C	SGM2036-2.9YUDH4G/TR	O8	Tape and Reel, 10000
SGM2036-3.0	UTDFN-1×1-4L	-40°C to +85°C	SGM2036-3.0YUDH4G/TR	I2	Tape and Reel, 10000
SGM2036-3.3	UTDFN-1×1-4L	-40°C to +85°C	SGM2036-3.3YUDH4G/TR	I3	Tape and Reel, 10000
SGM2036-0.8	SOT-23-5	-40°C to +85°C	SGM2036-0.8YN5G/TR	SS7XX	Tape and Reel, 3000
SGM2036-0.9	SOT-23-5	-40°C to +85°C	SGM2036-0.9YN5G/TR	SP0XX	Tape and Reel, 3000
SGM2036-1.0	SOT-23-5	-40°C to +85°C	SGM2036-1.0YN5G/TR	SP1XX	Tape and Reel, 3000
SGM2036-1.05	SOT-23-5	-40°C to +85°C	SGM2036-1.05YN5G/TR	SP2XX	Tape and Reel, 3000
SGM2036-1.1	SOT-23-5	-40°C to +85°C	SGM2036-1.1YN5G/TR	SP3XX	Tape and Reel, 3000
SGM2036-1.2	SOT-23-5	-40°C to +85°C	SGM2036-1.2YN5G/TR	SP4XX	Tape and Reel, 3000
SGM2036-1.3	SOT-23-5	-40°C to +85°C	SGM2036-1.3YN5G/TR	SP5XX	Tape and Reel, 3000
SGM2036-1.5	SOT-23-5	-40°C to +85°C	SGM2036-1.5YN5G/TR	SP6XX	Tape and Reel, 3000
SGM2036-1.8	SOT-23-5	-40°C to +85°C	SGM2036-1.8YN5G/TR	SP7XX	Tape and Reel, 3000
SGM2036-1.85	SOT-23-5	-40°C to +85°C	SGM2036-1.85YN5G/TR	SP8XX	Tape and Reel, 3000
SGM2036-2.1	SOT-23-5	-40°C to +85°C	SGM2036-2.1YN5G/TR	SP9XX	Tape and Reel, 3000
SGM2036-2.2	SOT-23-5	-40°C to +85°C	SGM2036-2.2YN5G/TR	SPAXX	Tape and Reel, 3000
SGM2036-2.3	SOT-23-5	-40°C to +85°C	SGM2036-2.3YN5G/TR	SS9XX	Tape and Reel, 3000
SGM2036-2.5	SOT-23-5	-40°C to +85°C	SGM2036-2.5YN5G/TR	SPBXX	Tape and Reel, 3000
SGM2036-2.6	SOT-23-5	-40°C to +85°C	SGM2036-2.6YN5G/TR	SN5XX	Tape and Reel, 3000
SGM2036-2.7	SOT-23-5	-40°C to +85°C	SGM2036-2.7YN5G/TR	SPCXX	Tape and Reel, 3000
SGM2036-2.8	SOT-23-5	-40°C to +85°C	SGM2036-2.8YN5G/TR	SPDXX	Tape and Reel, 3000
SGM2036-2.85	SOT-23-5	-40°C to +85°C	SGM2036-2.85YN5G/TR	SPEXX	Tape and Reel, 3000
SGM2036-2.9	SOT-23-5	-40°C to +85°C	SGM2036-2.9YN5G/TR	SPFXX	Tape and Reel, 3000

**PACKAGE/ORDERING INFORMATION (continued)**

MODEL	PACKAGE DESCRIPTION	SPECIFIED TEMPERATURE RANGE	ORDERING NUMBER	PACKAGE MARKING	PACKING OPTION
SGM2036-3.0	SOT-23-5	-40°C to +85°C	SGM2036-3.0YN5G/TR	SQ0XX	Tape and Reel, 3000
SGM2036-3.1	SOT-23-5	-40°C to +85°C	SGM2036-3.1YN5G/TR	SQ1XX	Tape and Reel, 3000
SGM2036-3.3	SOT-23-5	-40°C to +85°C	SGM2036-3.3YN5G/TR	SQ2XX	Tape and Reel, 3000
SGM2036-3.6	SOT-23-5	-40°C to +85°C	SGM2036-3.6YN5G/TR	SQ3XX	Tape and Reel, 3000
SGM2036-4.2	SOT-23-5	-40°C to +85°C	SGM2036-4.2YN5G/TR	SQ4XX	Tape and Reel, 3000
SGM2036-4.4	SOT-23-5	-40°C to +85°C	SGM2036-4.4YN5G/TR	SQ5XX	Tape and Reel, 3000
SGM2036-5.0	SOT-23-5	-40°C to +85°C	SGM2036-5.0YN5G/TR	SQ6XX	Tape and Reel, 3000
SGM2036-ADJ	SOT-23-5	-40°C to +85°C	SGM2036-ADJYN5G/TR	SQ7XX	Tape and Reel, 3000
SGM2036-0.8	SC70-5	-40°C to +85°C	SGM2036-0.8YC5G/TR	SSBXX	Tape and Reel, 3000
SGM2036-0.9	SC70-5	-40°C to +85°C	SGM2036-0.9YC5G/TR	SQ8XX	Tape and Reel, 3000
SGM2036-1.0	SC70-5	-40°C to +85°C	SGM2036-1.0YC5G/TR	SQ9XX	Tape and Reel, 3000
SGM2036-1.05	SC70-5	-40°C to +85°C	SGM2036-1.05YC5G/TR	SQAXX	Tape and Reel, 3000
SGM2036-1.1	SC70-5	-40°C to +85°C	SGM2036-1.1YC5G/TR	SQBXX	Tape and Reel, 3000
SGM2036-1.2	SC70-5	-40°C to +85°C	SGM2036-1.2YC5G/TR	SQCXX	Tape and Reel, 3000
SGM2036-1.3	SC70-5	-40°C to +85°C	SGM2036-1.3YC5G/TR	SQDXX	Tape and Reel, 3000
SGM2036-1.5	SC70-5	-40°C to +85°C	SGM2036-1.5YC5G/TR	SQEXX	Tape and Reel, 3000
SGM2036-1.8	SC70-5	-40°C to +85°C	SGM2036-1.8YC5G/TR	SQFXX	Tape and Reel, 3000
SGM2036-1.85	SC70-5	-40°C to +85°C	SGM2036-1.85YC5G/TR	SR0XX	Tape and Reel, 3000
SGM2036-2.1	SC70-5	-40°C to +85°C	SGM2036-2.1YC5G/TR	SR1XX	Tape and Reel, 3000
SGM2036-2.2	SC70-5	-40°C to +85°C	SGM2036-2.2YC5G/TR	SR2XX	Tape and Reel, 3000
SGM2036-2.3	SC70-5	-40°C to +85°C	SGM2036-2.3YC5G/TR	SS8XX	Tape and Reel, 3000
SGM2036-2.5	SC70-5	-40°C to +85°C	SGM2036-2.5YC5G/TR	SR3XX	Tape and Reel, 3000
SGM2036-2.6	SC70-5	-40°C to +85°C	SGM2036-2.6YC5G/TR	SN4XX	Tape and Reel, 3000
SGM2036-2.7	SC70-5	-40°C to +85°C	SGM2036-2.7YC5G/TR	SR4XX	Tape and Reel, 3000
SGM2036-2.8	SC70-5	-40°C to +85°C	SGM2036-2.8YC5G/TR	SR5XX	Tape and Reel, 3000
SGM2036-2.85	SC70-5	-40°C to +85°C	SGM2036-2.85YC5G/TR	SR6XX	Tape and Reel, 3000
SGM2036-2.9	SC70-5	-40°C to +85°C	SGM2036-2.9YC5G/TR	SR7XX	Tape and Reel, 3000
SGM2036-3.0	SC70-5	-40°C to +85°C	SGM2036-3.0YC5G/TR	SR8XX	Tape and Reel, 3000
SGM2036-3.1	SC70-5	-40°C to +85°C	SGM2036-3.1YC5G/TR	SR9XX	Tape and Reel, 3000
SGM2036-3.3	SC70-5	-40°C to +85°C	SGM2036-3.3YC5G/TR	SRAXX	Tape and Reel, 3000
SGM2036-3.6	SC70-5	-40°C to +85°C	SGM2036-3.6YC5G/TR	SRBXX	Tape and Reel, 3000
SGM2036-4.2	SC70-5	-40°C to +85°C	SGM2036-4.2YC5G/TR	SRCXX	Tape and Reel, 3000
SGM2036-4.4	SC70-5	-40°C to +85°C	SGM2036-4.4YC5G/TR	SRDXX	Tape and Reel, 3000
SGM2036-5.0	SC70-5	-40°C to +85°C	SGM2036-5.0YC5G/TR	SREXX	Tape and Reel, 3000
SGM2036-ADJ	SC70-5	-40°C to +85°C	SGM2036-ADJYC5G/TR	SRFXX	Tape and Reel, 3000

**MARKING INFORMATION**

NOTE: XX = Date Code.

**UTDFN-1×1-4L**

**YY**

Serial Number

**SOT-23-5/SC70-5**

**YYY X X**

Date Code - Month  
Date Code - Year  
Serial Number

Green (RoHS & HSF): SG Micro Corp defines "Green" to mean Pb-Free (RoHS compatible) and free of halogen substances. If you have additional comments or questions, please contact your SGMICRO representative directly.

**ABSOLUTE MAXIMUM RATINGS**

IN to GND .....	-0.3V to 6V
Output Short-Circuit Duration.....	Infinite
EN to GND.....	-0.3V to 6V
OUT, BP/FB to GND .....	-0.3V to ( $V_{IN} + 0.3V$ )
Power Dissipation, $P_D$ @ $T_A = +25^\circ C$	
UTDFN-1×1-4L .....	400mW
SOT-23-5.....	390mW
SC70-5.....	340mW
Package Thermal Resistance	
UTDFN-1×1-4L, $\theta_{JA}$ .....	280°C/W
SOT-23-5, $\theta_{JA}$ .....	285°C/W
SC70-5, $\theta_{JA}$ .....	330°C/W
Junction Temperature .....	+150°C
Storage Temperature Range.....	-65°C to +150°C
Lead Temperature (Soldering, 10s).....	+260°C
ESD Susceptibility	
HBM.....	4000V
MM.....	400V

**RECOMMENDED OPERATING CONDITIONS**

Operating Voltage Range.....	1.6V to 5.5V
Enable Input Voltage Range .....	0V to 5.5V
Input Effective Capacitance, $C_{IN}$ .....	0.1 $\mu$ F (MIN)
Output Effective Capacitance, $C_{OUT}$ .....	0.5 $\mu$ F to 10 $\mu$ F
Operating Temperature Range .....	-40°C to +85°C

**OVERSTRESS CAUTION**

Stresses beyond those listed in Absolute Maximum Ratings may cause permanent damage to the device. Exposure to absolute maximum rating conditions for extended periods may affect reliability. Functional operation of the device at any conditions beyond those indicated in the Recommended Operating Conditions section is not implied.

**ESD SENSITIVITY CAUTION**

This integrated circuit can be damaged if ESD protections are not considered carefully. SGMICRO recommends that all integrated circuits be handled with appropriate precautions. Failure to observe proper handling and installation procedures can cause damage. ESD damage can range from subtle performance degradation to complete device failure. Precision integrated circuits may be more susceptible to damage because even small parametric changes could cause the device not to meet the published specifications.

**DISCLAIMER**

SG Micro Corp reserves the right to make any change in circuit design, or specifications without prior notice.

**PIN CONFIGURATIONS**

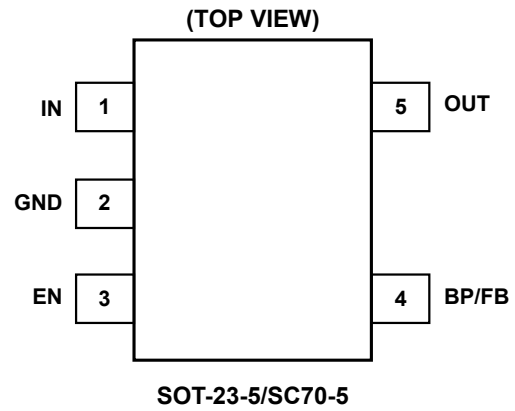
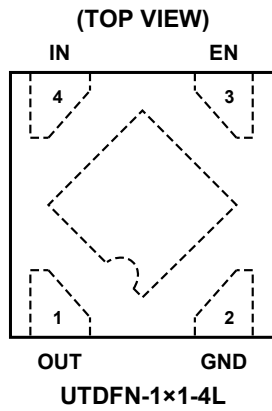

**PIN DESCRIPTION**

PIN		NAME	FUNCTION
UTDNF-1x1-4L	SOT-23-5/ SC70-5		
1	5	OUT	Regulator Output Pin. It is recommended to use a ceramic capacitor with effective capacitance in the range of 0.5μF to 10μF to get good power supply decoupling. This ceramic capacitor should be placed as close as possible to OUT pin.
2	2	GND	Ground.
3	3	EN	Enable Pin. Drive EN high to turn on the regulator. Drive EN low to turn off the regulator. This pin must be pulled high by an external resistor connected to IN pin if EN pin is not used.
4	1	IN	Input Voltage Supply Pin. It is recommended to use a 1μF or larger ceramic capacitor from IN pin to ground. This ceramic capacitor should be placed as close as possible to IN pin.
-	4	BP	Reference-Noise Bypass Pin (fixed voltage version only). Bypass with an external capacitor C <sub>BP</sub> can reduce output noise to very low level. The capacitor is recommended to be placed very close to the pin for high PSRR.
		FB	Feedback Voltage Input Pin (adjustable voltage version only). Connect this pin to the external resistor divider to adjust the output voltage. Place the resistors as close as possible to this pin.
Exposed Pad	-	-	Exposed Pad. Connect it to GND internally. Connect it to a large ground plane to maximize thermal performance; this pad is not an electrical connection point.

## ELECTRICAL CHARACTERISTICS

(V<sub>IN</sub> = (V<sub>OUT (NOMINAL)</sub> + 0.5V) or 2.5V (whichever is greater), Full = -40°C to +85°C, unless otherwise noted.)

PARAMETER	SYMBOL	CONDITIONS	TEMP	MIN	TYP	MAX	UNITS	
Input Voltage Range	V <sub>IN</sub>		+25°C	1.6		5.5	V	
Output Voltage Accuracy		I <sub>OUT</sub> = 0.1mA	+25°C	-2.5		+2.5	%	
Feedback Voltage	V <sub>FB</sub>	I <sub>OUT</sub> = 0.1mA, SGM2036-ADJ	+25°C	0.78	0.8	0.82	V	
Maximum Output Current			+25°C	300			mA	
Output Current Limit	I <sub>LIMIT</sub>		+25°C	360	560		mA	
Supply Pin Current	I <sub>Q</sub>	No Load, V <sub>EN</sub> = V <sub>IN</sub>	+25°C		20	26	μA	
Dropout Voltage <sup>(1)</sup>	V <sub>DROP</sub>	I <sub>OUT</sub> = 300mA	V <sub>OUT</sub> = 0.8V	+25°C	940	1200	mV	
			V <sub>OUT</sub> = 0.9V	+25°C	840	1100		
			1.0V ≤ V <sub>OUT</sub> < 1.1V	+25°C	780	1000		
			1.1V ≤ V <sub>OUT</sub> < 1.2V	+25°C	680	900		
			1.2V ≤ V <sub>OUT</sub> < 1.5V	+25°C	590	800		
			1.5V ≤ V <sub>OUT</sub> < 1.8V	+25°C	420	550		
			1.8V ≤ V <sub>OUT</sub> < 2.1V	+25°C	320	420		
			2.1V ≤ V <sub>OUT</sub> < 2.5V	+25°C	260	340		
			2.5V ≤ V <sub>OUT</sub> < 3.0V	+25°C	215	280		
			3.0V ≤ V <sub>OUT</sub> < 3.6V	+25°C	190	250		
		3.6V ≤ V <sub>OUT</sub> ≤ 5.0V	+25°C	165	210			
Line Regulation	$\frac{\Delta V_{OUT}}{\Delta V_{IN} \times V_{OUT}}$	V <sub>IN</sub> = 1.6V or (V <sub>OUT</sub> + 0.5V) to 5.5V, I <sub>OUT</sub> = 1mA	1.8V ≤ V <sub>OUT</sub> ≤ 3.3V	+25°C	0.01	0.06	%V	
			V <sub>OUT</sub> < 1.8V or V <sub>OUT</sub> > 3.3V	+25°C	0.01	0.1		
Load Regulation	ΔV <sub>OUT</sub>	I <sub>OUT</sub> = 0.1mA to 300mA	+25°C	12	40	mV		
		I <sub>OUT</sub> = 0.1mA to 300mA, SGM2036-ADJ	+25°C	0.5	10			
Short-Circuit Current	I <sub>SHORT</sub>	V <sub>OUT</sub> = 0V	+25°C		200		mA	
Power Supply Rejection Ratio	PSRR	C <sub>BP</sub> = 0μF, I <sub>OUT</sub> = 30mA, C <sub>OUT</sub> = 1μF, V <sub>IN</sub> = V <sub>OUT</sub> + 1V, ΔV <sub>RIPPLE</sub> = 0.2V <sub>P-P</sub>	f = 217Hz	+25°C	80		dB	
			f = 1kHz	+25°C	75			
			C <sub>BP</sub> = 0.01μF, I <sub>OUT</sub> = 30mA, C <sub>OUT</sub> = 1μF, V <sub>IN</sub> = V <sub>OUT</sub> + 1V, ΔV <sub>RIPPLE</sub> = 0.2V <sub>P-P</sub>	f = 217Hz	+25°C	82		
			f = 1kHz	+25°C	70			
Output Voltage Noise	e <sub>n</sub>	C <sub>BP</sub> = 0μF, f = 10Hz to 100kHz, C <sub>OUT</sub> = 1μF, V <sub>OUT</sub> = 1.8V	I <sub>OUT</sub> = 0mA	+25°C	100		μV <sub>RMS</sub>	
			I <sub>OUT</sub> = 30mA	+25°C	200			
			C <sub>BP</sub> = 0.01μF, f = 10Hz to 100kHz, C <sub>OUT</sub> = 1μF, V <sub>OUT</sub> = 1.8V	I <sub>OUT</sub> = 0mA	+25°C	30		
			I <sub>OUT</sub> = 30mA	+25°C	75			
Output Voltage Temperature Coefficient <sup>(2)</sup>	$\frac{\Delta V_{OUT}}{\Delta T_A \times V_{OUT}}$	I <sub>OUT</sub> = 0.1mA	Full		30		ppm/°C	
<b>Shutdown</b>								
EN Input Threshold	V <sub>IH</sub>	V <sub>IN</sub> = 1.6V to 5.5V	Full	1.5			V	
	V <sub>IL</sub>		Full			0.4		
EN Input Bias Current	I <sub>BH</sub>	V <sub>EN</sub> = 5.5V	Full		0.8	2	μA	
	I <sub>BL</sub>	V <sub>EN</sub> = 0V	Full		0.01	1		
Shutdown Supply Current	I <sub>SHDN</sub>	V <sub>EN</sub> = 0V	Full		0.01	1	μA	
Start-Up Time <sup>(3)</sup>	t <sub>STR</sub>	C <sub>OUT</sub> = 1μF, No Load	+25°C		30		μs	
Output Discharge Resistance	R <sub>DIS</sub>	V <sub>IN</sub> = 4.0V, V <sub>EN</sub> = 0V	+25°C		50		Ω	

**ELECTRICAL CHARACTERISTICS (continued)**(V<sub>IN</sub> = V<sub>OUT (NOMINAL)</sub> + 0.5V or 2.5V, whichever is greater, Full = -40°C to +85°C, unless otherwise noted.)

PARAMETER	SYMBOL	CONDITIONS	MIN	TYP	MAX	UNITS
<b>Thermal Protection</b>						
Thermal Shutdown Temperature	T <sub>SHDN</sub>			140		°C
Thermal Shutdown Hysteresis	ΔT <sub>SHDN</sub>			15		°C

## NOTES:

1. The dropout voltage is defined as the difference between V<sub>IN</sub> and V<sub>OUT</sub> when V<sub>OUT</sub> falls to V<sub>OUT</sub> - 100mV.
2. Output voltage temperature coefficient is defined as the worst-case voltage change divided by the total temperature range.
3. Time needed for V<sub>OUT</sub> to reach 90% of final value.

TYPICAL PERFORMANCE CHARACTERISTICS

$T_A = +25^\circ\text{C}$ ,  $V_{EN} = V_{IN}$ ,  $C_{IN} = 1\mu\text{F}$ ,  $C_{OUT} = 1\mu\text{F}$ ,  $C_{BP} = 0\mu\text{F}$ , unless otherwise noted.

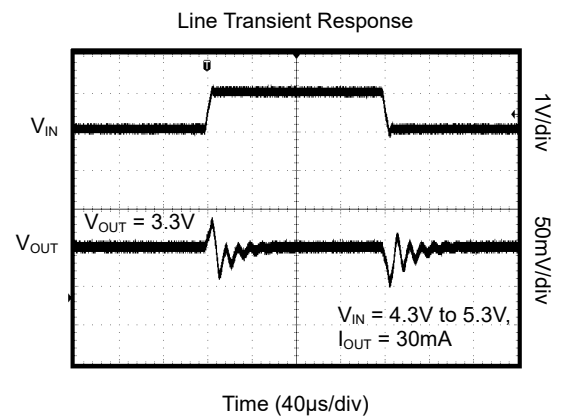
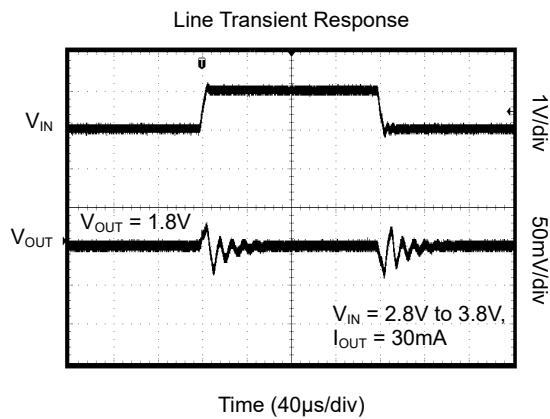
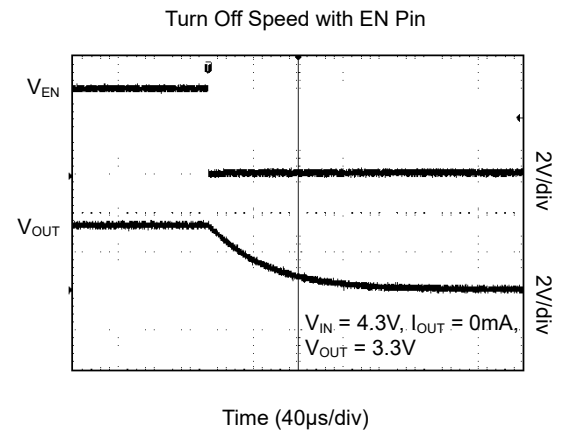
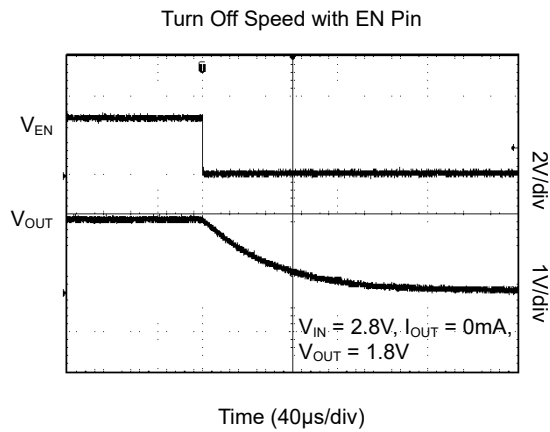
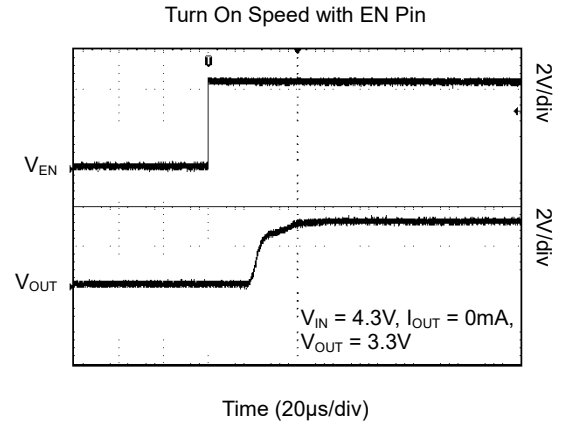
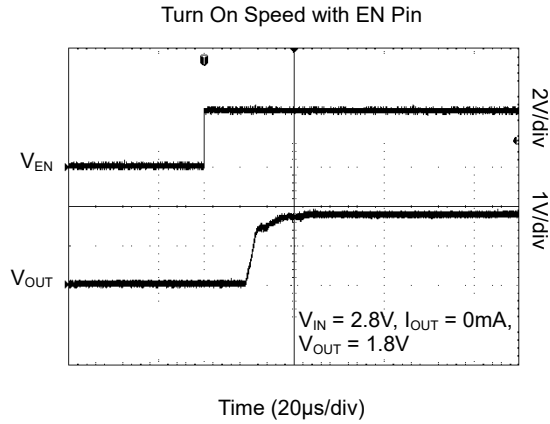



TYPICAL PERFORMANCE CHARACTERISTICS (continued)

$T_A = +25^\circ\text{C}$ ,  $V_{EN} = V_{IN}$ ,  $C_{IN} = 1\mu\text{F}$ ,  $C_{OUT} = 1\mu\text{F}$ ,  $C_{BP} = 0\mu\text{F}$ , unless otherwise noted.

Load Transient Response

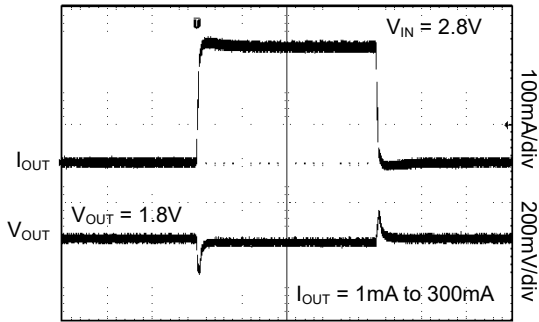

Time (100µs/div)

Load Transient Response

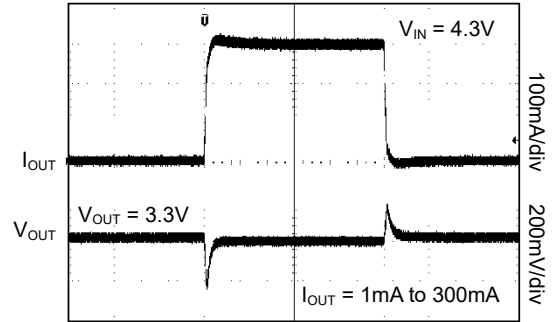

Time (100µs/div)

Load Transient Response

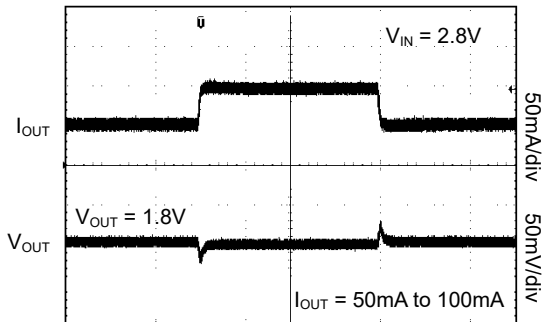

Time (100µs/div)

Load Transient Response

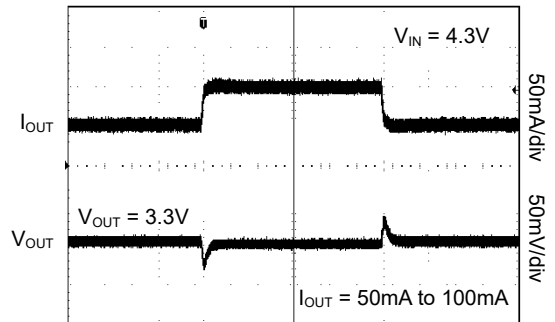

Time (100µs/div)

Power Supply Rejection Ratio vs. Frequency

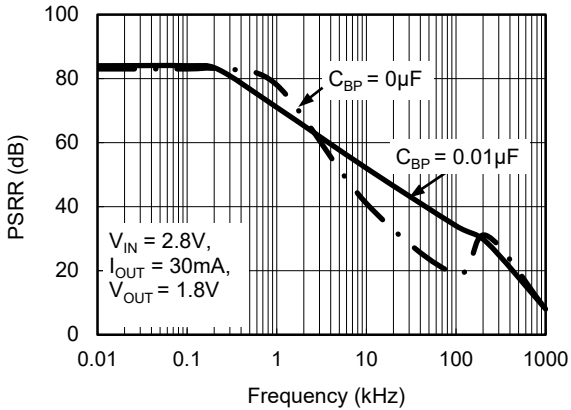

Power Supply Rejection Ratio vs. Frequency

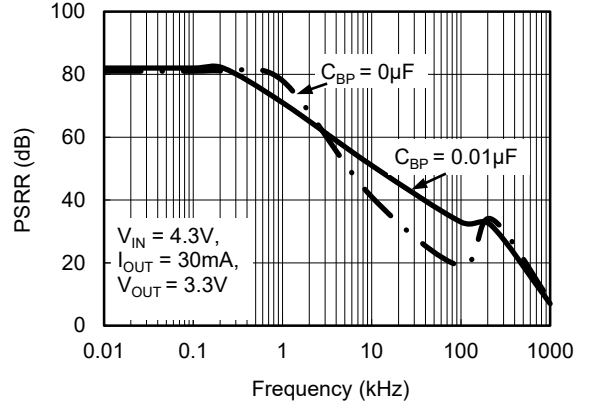

TYPICAL PERFORMANCE CHARACTERISTICS (continued)

$T_A = +25^\circ\text{C}$ ,  $V_{EN} = V_{IN}$ ,  $C_{IN} = 1\mu\text{F}$ ,  $C_{OUT} = 1\mu\text{F}$ ,  $C_{BP} = 0\mu\text{F}$ , unless otherwise noted.

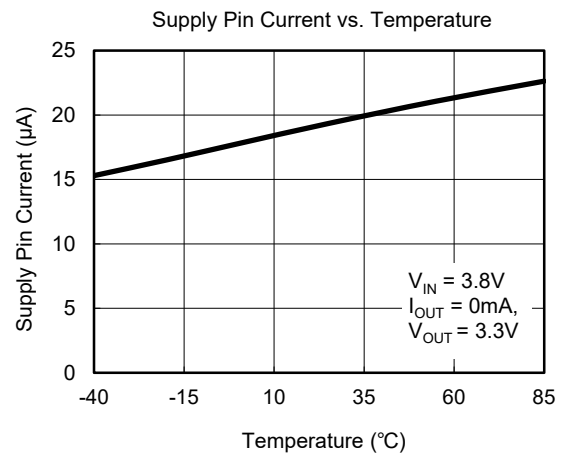
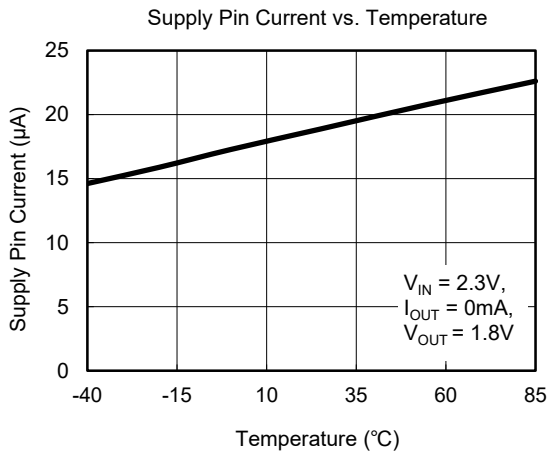
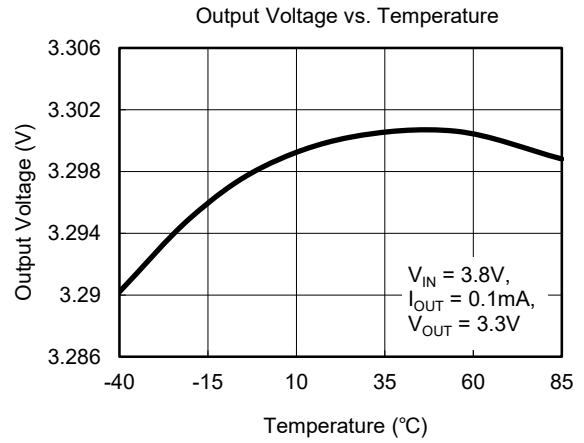
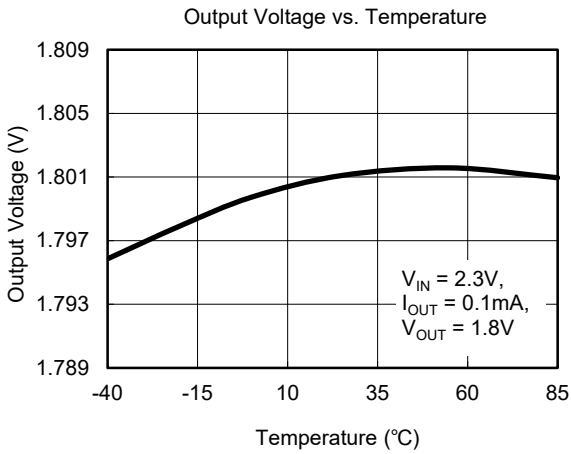
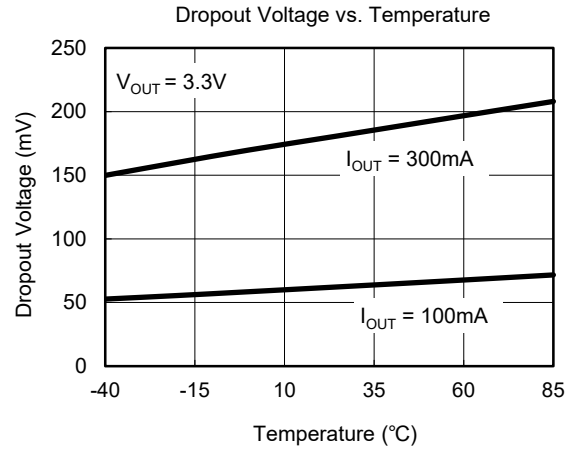
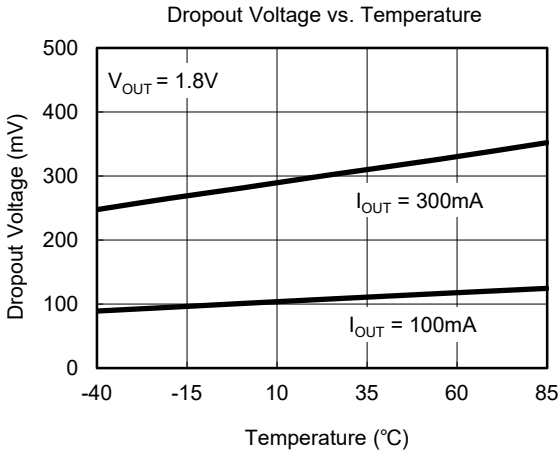

TYPICAL PERFORMANCE CHARACTERISTICS (continued)

$T_A = +25^\circ\text{C}$ ,  $V_{EN} = V_{IN}$ ,  $C_{IN} = 1\mu\text{F}$ ,  $C_{OUT} = 1\mu\text{F}$ ,  $C_{BP} = 0\mu\text{F}$ , unless otherwise noted.

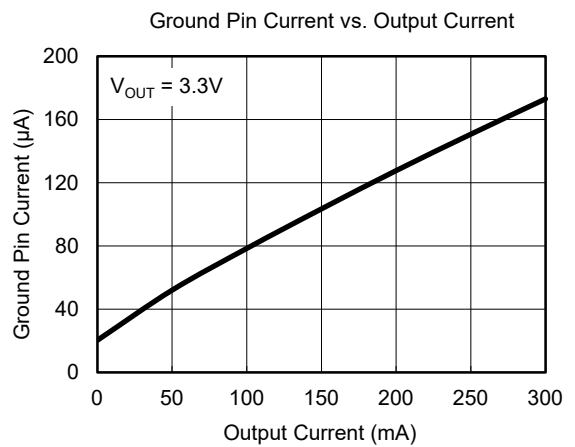
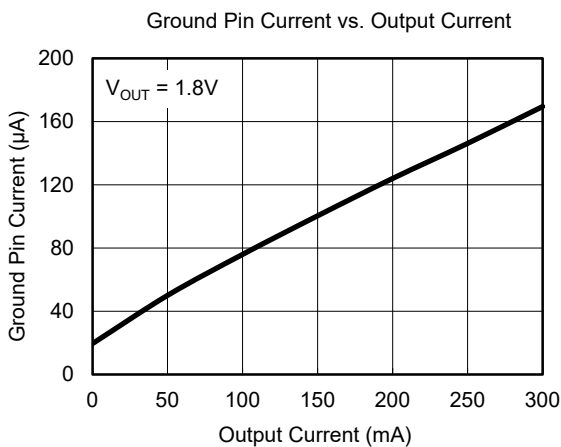
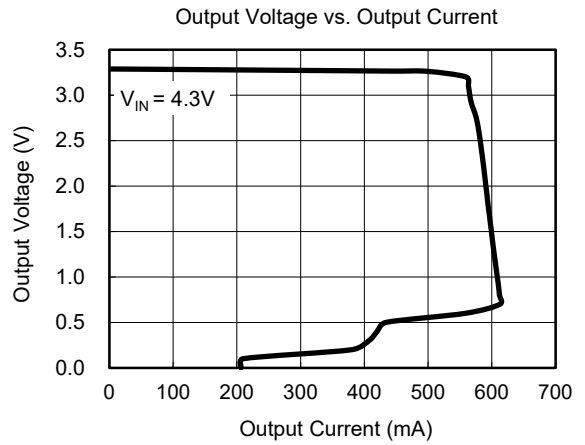
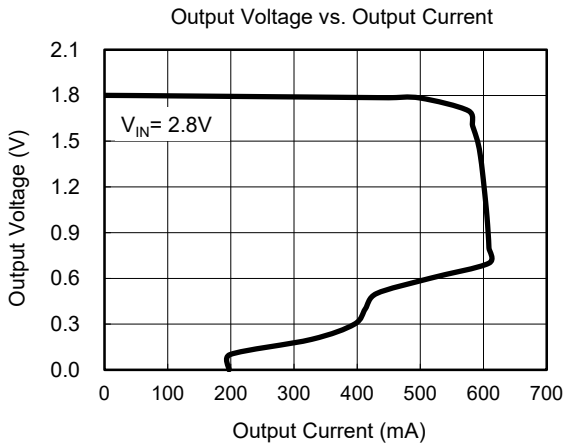
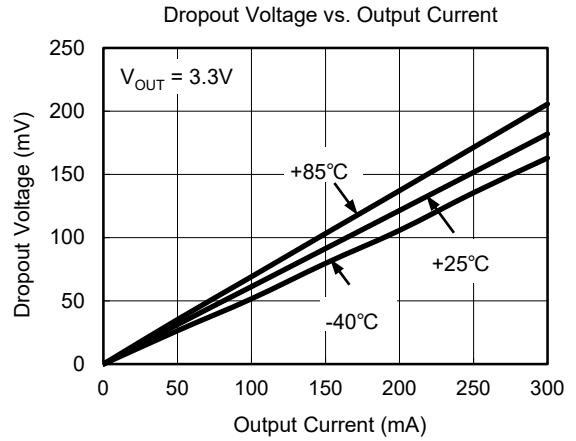
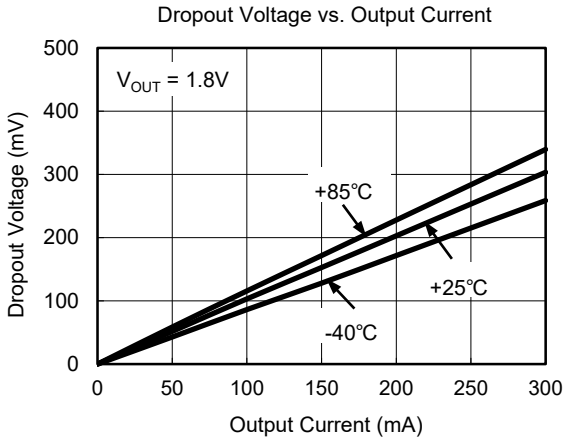

**TYPICAL PERFORMANCE CHARACTERISTICS (continued)**

$T_A = +25^\circ\text{C}$ ,  $V_{EN} = V_{IN}$ ,  $C_{IN} = 1\mu\text{F}$ ,  $C_{OUT} = 1\mu\text{F}$ ,  $C_{BP} = 0\mu\text{F}$ , unless otherwise noted.

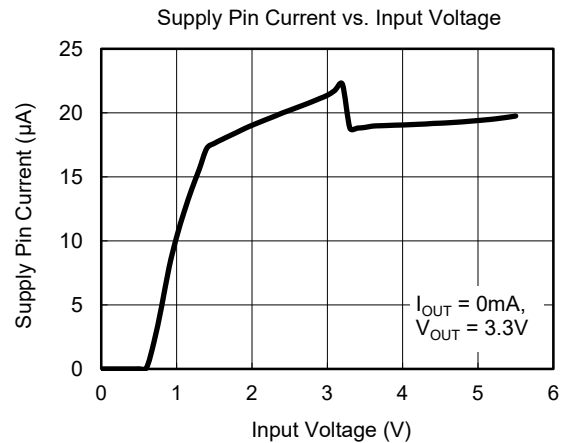
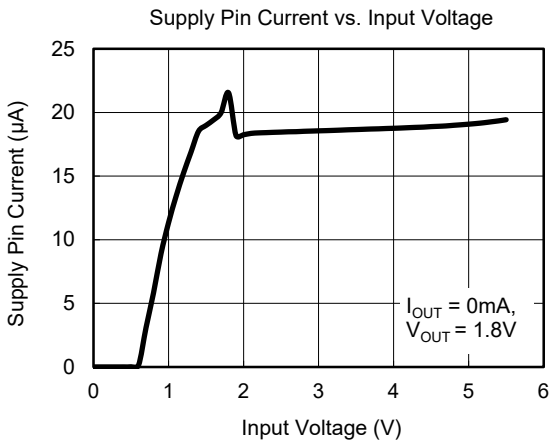
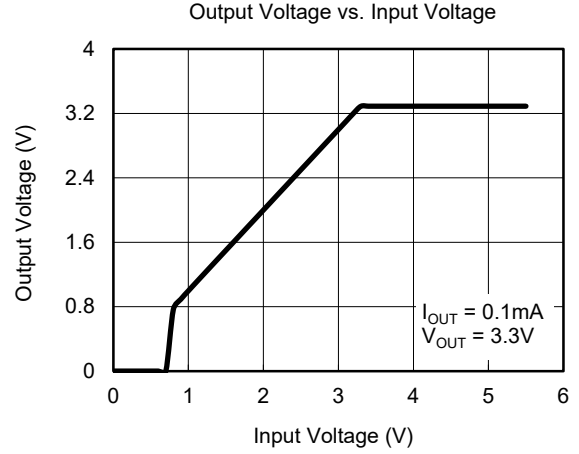
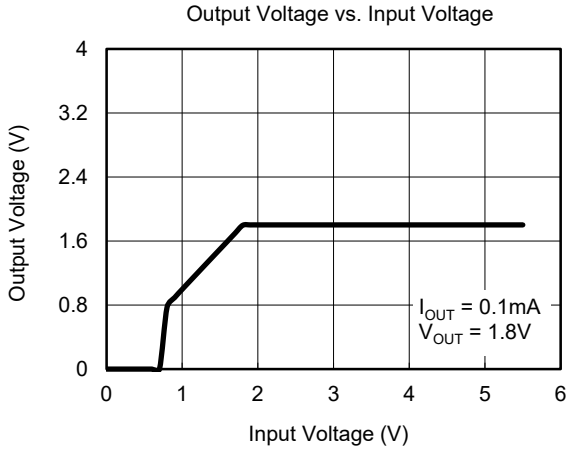

FUNCTIONAL BLOCK DIAGRAMS

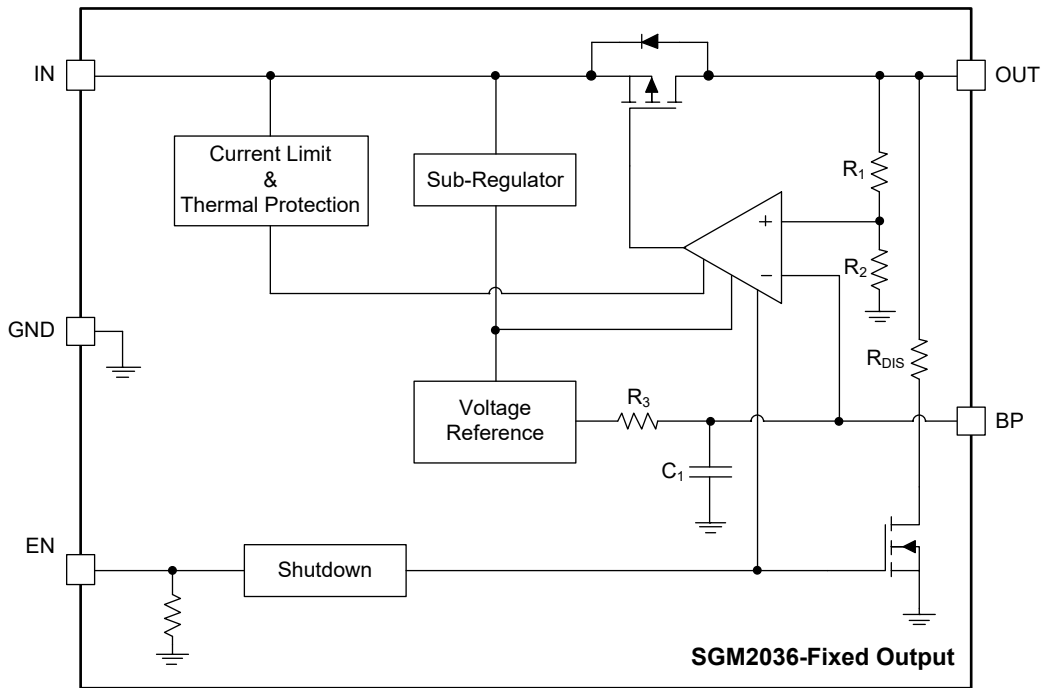

Figure 1. Internal Block Diagram of Fixed Output Voltage

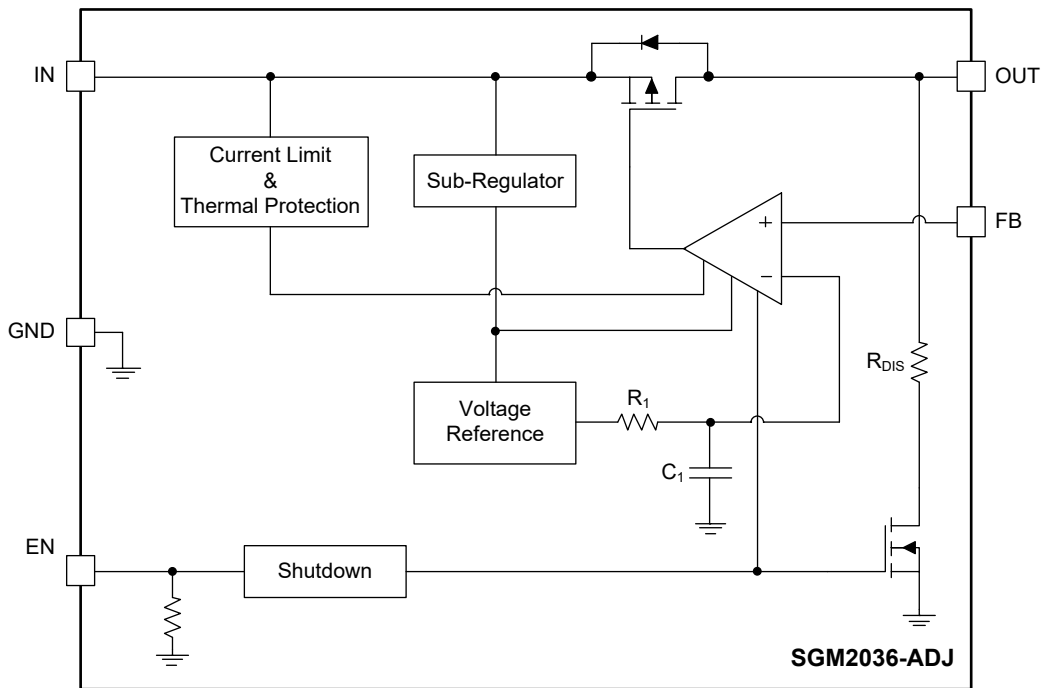
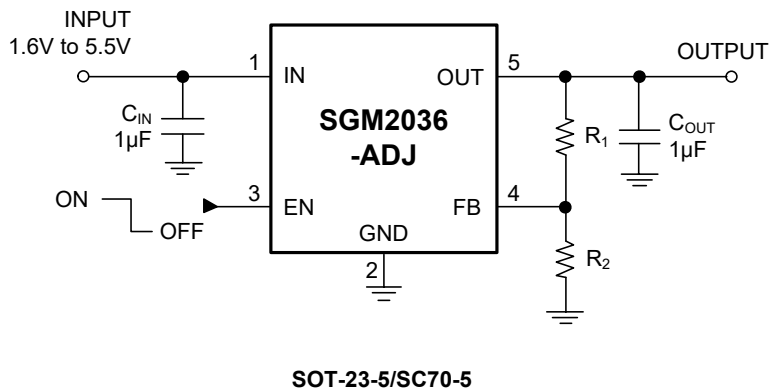
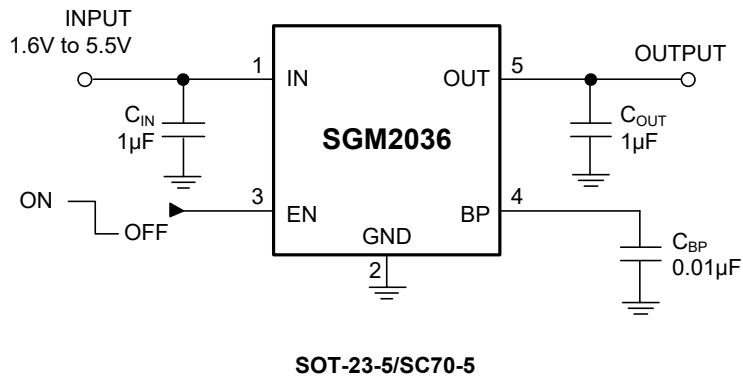

Figure 2. Internal Block Diagram of Adjustable Output Voltage

TYPICAL APPLICATION CIRCUITS



NOTE: Choose  $R_2 = 160k\Omega$  to maintain a  $5\mu A$  minimum load. Calculate the value for  $R_1$  using the following equation:

$$R_1 = R_2 \times \left( \frac{V_{OUT}}{0.8V} - 1 \right)$$

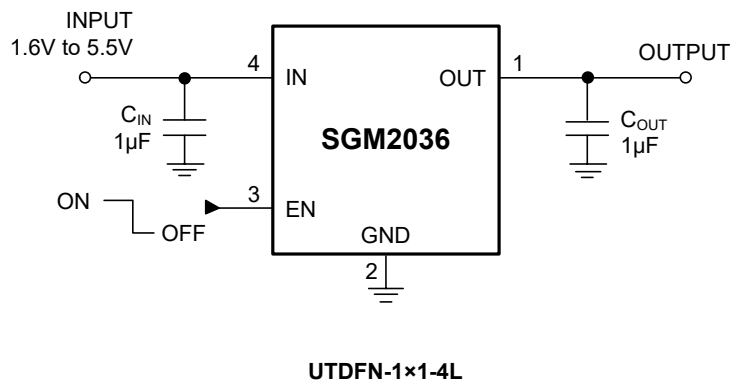

## APPLICATION INFORMATION

The SGM2036 is a low input voltage, ultra-low noise and low dropout LDO and provides 300mA output current. These features make the device a reliable solution to solve many challenging problems in the generation of clean and accurate power supply. The high performance also makes the SGM2036 useful in a variety of applications. The SGM2036 provides the protection function for output overload, output short-circuit condition and overheating.

The SGM2036 provides an EN pin as an external chip enable control to enable/disable the device. When the regulator is in shutdown state, the shutdown current consumes as low as 0.01 $\mu$ A (TYP).

### Input Capacitor Selection ( $C_{IN}$ )

The input decoupling capacitor is necessary to be connected as close as possible to the IN pin for ensuring the device stability. 1 $\mu$ F or greater X7R or X5R ceramic capacitor is selected to get good dynamic performance.

When  $V_{IN}$  is required to provide large current instantaneously, a large effective input capacitor is required. Multiple input capacitors can limit the input tracking inductance. Adding more input capacitors is available to restrict the ringing and to keep it below the device absolute maximum ratings.

### Output Capacitor Selection ( $C_{OUT}$ )

The output decoupling capacitor should be located as close as possible to the OUT pin. 1 $\mu$ F or greater X7R or X5R ceramic capacitor is selected to get good dynamic performance. The minimum effective capacitance of  $C_{OUT}$  that SGM2036 can remain stable is 0.5 $\mu$ F. For ceramic capacitor, temperature, DC bias and package size will change the effective capacitance, so enough margin of  $C_{OUT}$  must be considered in design. Larger capacitance and lower ESR  $C_{OUT}$  will help improve the load transient response and increase the high frequency PSRR.

### Enable Control

The SGM2036 uses the EN pin to enable/disable its device and to deactivate/activate the output automatic discharge function.

When the EN pin voltage is lower than 0.4V, the device is in shutdown state, there is no current flowing from IN to OUT pins. In this state, the automatic discharge transistor is active to discharge the output voltage through a 50 $\Omega$  (TYP) resistor.

When the EN pin voltage is higher than 1.5V, the device is in active state, the input voltage is regulated to the output voltage and the automatic discharge transistor is turned off.

The EN pin is pulled down by internal 0.8 $\mu$ A (TYP) current source when the EN pin is floated. This current source will ensure the SGM2036 in shutdown state and reduce the power dissipation in system.

### Reverse Current

The pass transistor has an inherent body diode which will be forward biased in the case when  $V_{OUT} > (V_{IN} + 0.3V)$ . If extended reverse voltage operation is anticipated, external limiting might be appropriate.

### Negatively Biased Output

When the output is negative voltage, the chip may not start up due to parasitic effects. Ensure that the output is greater than -0.3V under all conditions. If excessive negatively biased output is expected in the application, a Schottky diode can be added between the OUT pin and GND pin.

### Output Current Limit and Short-Circuit Protection

When overload events happen, the output current is internally limited to 560mA (TYP). When the OUT pin is shorted to ground, the short-circuit protection will limit the output current to 200mA (TYP).

### Thermal Shutdown

The SGM2036 can detect the temperature of die. When the die temperature exceeds the threshold value of thermal shutdown, the SGM2036 will be in shutdown state and it will remain in this state until the die temperature decreases to +140°C.

**REVISION HISTORY**

NOTE: Page numbers for previous revisions may differ from page numbers in the current version.

<b>NOVEMBER 2021 – REV.B.1 to REV.B.2</b>	<b>Page</b>
Updated Recommended Operating Conditions section .....	4
Updated Package Outline Dimensions section .....	16
<b>NOVEMBER 2017 – REV.B to REV.B.1</b>	<b>Page</b>
Updated Package/Ordering Information section .....	2-4
<b>DECEMBER 2015 – REV.A.4 to REV.B</b>	<b>Page</b>
Added output voltage temperature coefficient.....	7
<b>NOVEMBER 2015 – REV.A.3 to REV.A.4</b>	<b>Page</b>
Updated package name .....	6
<b>APRIL 2015 – REV.A.2 to REV.A.3</b>	<b>Page</b>
Added SC70-5 package .....	All
<b>NOVEMBER 2014 – REV.A.1 to REV.A.2</b>	<b>Page</b>
Added SGM2036-1.35YUDH4G version.....	1-3
<b>SEPTEMBER 2014 – REV.A to REV.A.1</b>	<b>Page</b>
Added load regulation maximum value .....	7
<b>Changes from Original (JUNE 2014) to REV.A</b>	<b>Page</b>
Changed from product preview to production data .....	All



PACKAGE OUTLINE DIMENSIONS

SC70-5

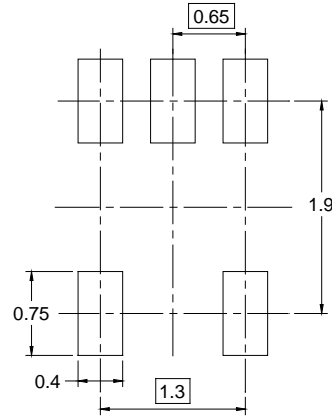
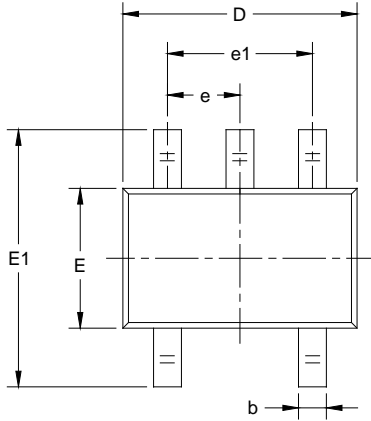

RECOMMENDED LAND PATTERN (Unit: mm)

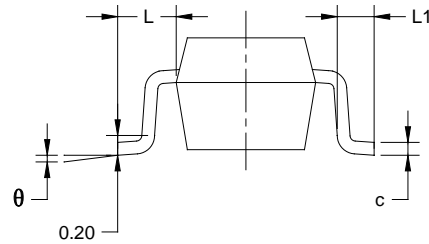
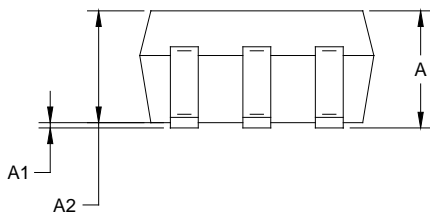

Symbol	Dimensions In Millimeters		Dimensions In Inches	
	MIN	MAX	MIN	MAX
A	0.800	1.100	0.031	0.043
A1	0.000	0.100	0.000	0.004
A2	0.800	1.000	0.031	0.039
b	0.150	0.350	0.006	0.014
c	0.080	0.220	0.003	0.009
D	2.000	2.200	0.079	0.087
E	1.150	1.350	0.045	0.053
E1	2.150	2.450	0.085	0.096
e	0.65 TYP		0.026 TYP	
e1	1.300 BSC		0.051 BSC	
L	0.525 REF		0.021 REF	
L1	0.260	0.460	0.010	0.018
$\theta$	0°	8°	0°	8°

NOTES:

1. Body dimensions do not include mode flash or protrusion.
2. This drawing is subject to change without notice.

PACKAGE OUTLINE DIMENSIONS

SOT-23-5

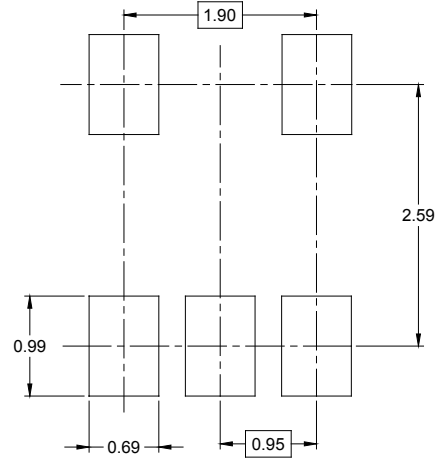
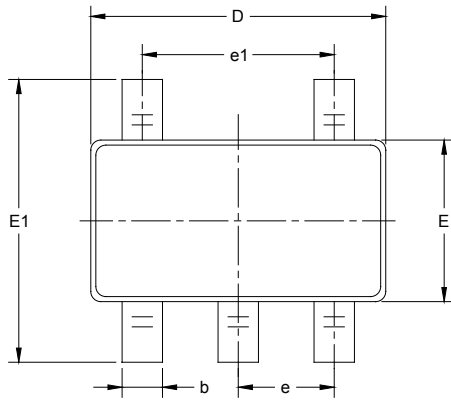

RECOMMENDED LAND PATTERN (Unit: mm)

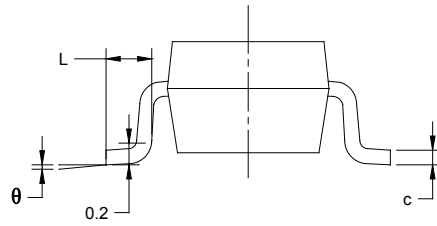
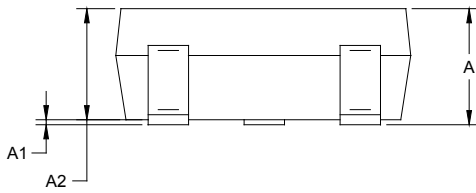

Symbol	Dimensions In Millimeters		Dimensions In Inches	
	MIN	MAX	MIN	MAX
A	1.050	1.250	0.041	0.049
A1	0.000	0.100	0.000	0.004
A2	1.050	1.150	0.041	0.045
b	0.300	0.500	0.012	0.020
c	0.100	0.200	0.004	0.008
D	2.820	3.020	0.111	0.119
E	1.500	1.700	0.059	0.067
E1	2.650	2.950	0.104	0.116
e	0.950 BSC		0.037 BSC	
e1	1.900 BSC		0.075 BSC	
L	0.300	0.600	0.012	0.024
$\theta$	0°	8°	0°	8°

## PACKAGE OUTLINE DIMENSIONS

### UTDFN-1×1-4L

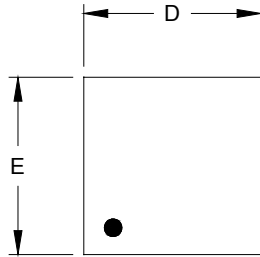

TOP VIEW

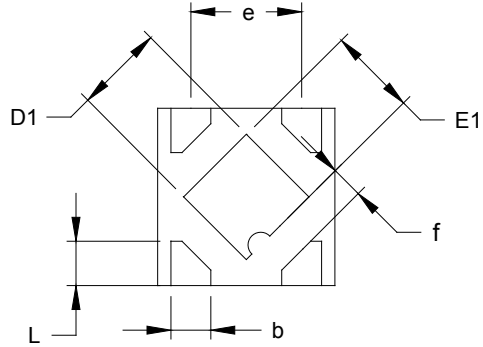

BOTTOM VIEW

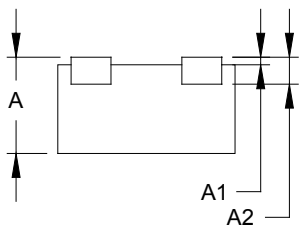

SIDE VIEW

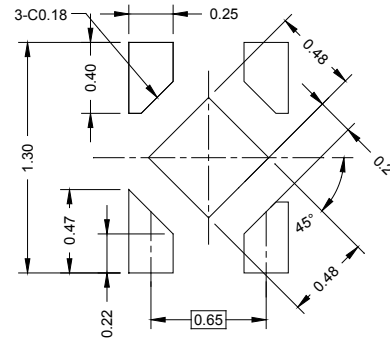

RECOMMENDED LAND PATTERN (Unit: mm)

Symbol	Dimensions In Millimeters		
	MIN	MOD	MAX
A	0.500	0.550	0.600
A1	0.000		0.050
A2	0.152 REF		
D	0.950	1.000	1.050
D1	0.450	0.500	0.550
E	0.950	1.000	1.050
E1	0.450	0.500	0.550
b	0.175	0.225	0.275
e	0.625 BSC		
f	0.195 REF		
L	0.200	0.250	0.300

# PACKAGE INFORMATION

## TAPE AND REEL INFORMATION

### REEL DIMENSIONS



### TAPE DIMENSIONS



NOTE: The picture is only for reference. Please make the object as the standard.

### KEY PARAMETER LIST OF TAPE AND REEL

Package Type	Reel Diameter	Reel Width W1 (mm)	A0 (mm)	B0 (mm)	K0 (mm)	P0 (mm)	P1 (mm)	P2 (mm)	W (mm)	Pin1 Quadrant
SC70-5	7"	9.5	2.25	2.55	1.20	4.0	4.0	2.0	8.0	Q3
SOT-23-5	7"	9.5	3.20	3.20	1.40	4.0	4.0	2.0	8.0	Q3
UTDFN-1×1-4L	7"	9.0	1.20	1.20	0.60	4.0	2.0	2.0	8.0	Q1

DD0001

# PACKAGE INFORMATION

## CARTON BOX DIMENSIONS



NOTE: The picture is only for reference. Please make the object as the standard.

## KEY PARAMETER LIST OF CARTON BOX

Reel Type	Length (mm)	Width (mm)	Height (mm)	Pizza/Carton
7" (Option)	368	227	224	8
7"	442	410	224	18

DD0002