

### GENERAL DESCRIPTION

The SGM2013 is a 3-terminal, low power and low dropout linear regulator. It is capable of supplying 300mA output current with typical dropout voltage of only 270mV. The operating input voltage range is from 2.5V to 5.5V and output voltage range is from 1.2V to 3.3V.

Other features include output current limit and thermal shutdown protection.

The SGM2013 is available in a Green SOT-89-3 package. It operates over an operating temperature range of -40°C to +125°C.

### FEATURES

- **Operating Input Voltage Range: 2.5V to 5.5V**
- **Fixed Output Voltages:**  
1.2V, 1.5V, 1.8V, 2.5V, 2.8V, 3.0V and 3.3V
- **Maximum Output Current: 300mA**
- **Output Voltage Accuracy:  $\pm 2.5\%$  at +25°C**
- **Low Output Noise: 140 $\mu$ V<sub>RMS</sub> (TYP)**
- **Low Dropout Voltage: 270mV (TYP) at 300mA**
- **High PSRR: 72dB (TYP) at 1kHz**
- **Thermal Shutdown Protection**
- **Output Current Limit**
- **-40°C to +125°C Operating Temperature Range**
- **Available in a Green SOT-89-3 Package**

### APPLICATIONS

Modems  
MP3 Players  
Cellular Telephones  
PCMCIA Cards  
Palmtop Computers  
Portable Electronics

### TYPICAL APPLICATION

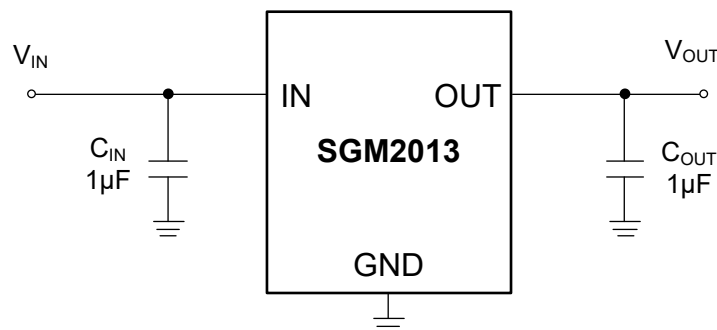

Figure 1. Typical Application Circuit

## PACKAGE/ORDERING INFORMATION

| MODEL       | V <sub>OUT</sub> (V) | PACKAGE DESCRIPTION | SPECIFIED TEMPERATURE RANGE | ORDERING NUMBER    | PACKAGE MARKING | PACKING OPTION      |
|-------------|----------------------|---------------------|-----------------------------|--------------------|-----------------|---------------------|
| SGM2013-1.2 | 1.2V                 | SOT-89-3            | -40°C to +125°C             | SGM2013-1.2XK3/TR  | SGM2013-1.2XK3  | Tape and Reel, 1000 |
|             |                      | SOT-89-3 (L-Type)   | -40°C to +125°C             | SGM2013-1.2XK3L/TR | SGM2013-1.2XK3L | Tape and Reel, 1000 |
| SGM2013-1.5 | 1.5V                 | SOT-89-3            | -40°C to +125°C             | SGM2013-1.5XK3/TR  | SGM2013-1.5XK3  | Tape and Reel, 1000 |
|             |                      | SOT-89-3 (L-Type)   | -40°C to +125°C             | SGM2013-1.5XK3L/TR | SGM2013-1.5XK3L | Tape and Reel, 1000 |
| SGM2013-1.8 | 1.8V                 | SOT-89-3            | -40°C to +125°C             | SGM2013-1.8XK3/TR  | SGM2013-1.8XK3  | Tape and Reel, 1000 |
|             |                      | SOT-89-3 (L-Type)   | -40°C to +125°C             | SGM2013-1.8XK3L/TR | SGM2013-1.8XK3L | Tape and Reel, 1000 |
| SGM2013-2.5 | 2.5V                 | SOT-89-3            | -40°C to +125°C             | SGM2013-2.5XK3/TR  | SGM2013-2.5XK3  | Tape and Reel, 1000 |
|             |                      | SOT-89-3 (L-Type)   | -40°C to +125°C             | SGM2013-2.5XK3L/TR | SGM2013-2.5XK3L | Tape and Reel, 1000 |
| SGM2013-2.8 | 2.8V                 | SOT-89-3            | -40°C to +125°C             | SGM2013-2.8XK3/TR  | SGM2013-2.8XK3  | Tape and Reel, 1000 |
|             |                      | SOT-89-3 (L-Type)   | -40°C to +125°C             | SGM2013-2.8XK3L/TR | SGM2013-2.8XK3L | Tape and Reel, 1000 |
| SGM2013-3.0 | 3.0V                 | SOT-89-3            | -40°C to +125°C             | SGM2013-3.0XK3/TR  | SGM2013-3.0XK3  | Tape and Reel, 1000 |
|             |                      | SOT-89-3 (L-Type)   | -40°C to +125°C             | SGM2013-3.0XK3L/TR | SGM2013-3.0XK3L | Tape and Reel, 1000 |
| SGM2013-3.3 | 3.3V                 | SOT-89-3            | -40°C to +125°C             | SGM2013-3.3XK3/TR  | SGM2013-3.3XK3  | Tape and Reel, 1000 |
|             |                      | SOT-89-3 (L-Type)   | -40°C to +125°C             | SGM2013-3.3XK3L/TR | SGM2013-3.3XK3L | Tape and Reel, 1000 |

Green (RoHS & HSF): SG Micro Corp defines "Green" to mean Pb-Free (RoHS compatible) and free of halogen substances. If you have additional comments or questions, please contact your SGMICRO representative directly.

## ABSOLUTE MAXIMUM RATINGS

|  |                                   |
|--|-----------------------------------|
| IN to GND .....  | 0.3V to 6V                        |
| Output Short-Circuit Duration.....                         | Infinite                          |
| OUT to GND .....   | -0.3V to (V <sub>IN</sub> + 0.3V) |
| Power Dissipation, P <sub>D</sub> @ T <sub>A</sub> = +25°C |                                   |
| SOT-89-3 .....   | 0.571W                            |
| Package Thermal Resistance                                 |                                   |
| SOT-89-3, θ <sub>JA</sub> .....                            | 175°C/W                           |
| Junction Temperature .....                                 | +150°C                            |
| Storage Temperature Range .....                            | -65°C to +150°C                   |
| Lead Temperature (Soldering, 10s) .....                    | +260°C                            |
| ESD Susceptibility   |                                   |
| HBM.....   | 4000V                             |
| MM.....  | 400V                              |

## RECOMMENDED OPERATING CONDITIONS

|                                   |                 |
|-----------------------------------|-----------------|
| Operating Temperature Range ..... | -40°C to +125°C |
|-----------------------------------|-----------------|

## OVERSTRESS CAUTION

Stresses beyond those listed in Absolute Maximum Ratings may cause permanent damage to the device. Exposure to absolute maximum rating conditions for extended periods may affect reliability. Functional operation of the device at any conditions beyond those indicated in the Recommended Operating Conditions section is not implied.

## ESD SENSITIVITY CAUTION

This integrated circuit can be damaged if ESD protections are not considered carefully. SGMICRO recommends that all integrated circuits be handled with appropriate precautions. Failure to observe proper handling and installation procedures can cause damage. ESD damage can range from subtle performance degradation to complete device failure. Precision integrated circuits may be more susceptible to damage because even small parametric changes could cause the device not to meet the published specifications.

## DISCLAIMER

SG Micro Corp reserves the right to make any change in circuit design, or specifications without prior notice.

**PIN CONFIGURATIONS**

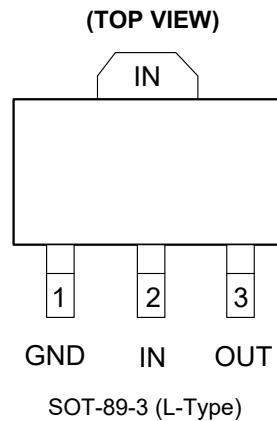
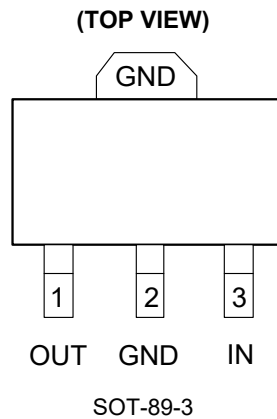

**PIN DESCRIPTION**

| PIN      |                   | NAME | FUNCTION  |
|----------|-------------------|------|---|
| SOT-89-3 | SOT-89-3 (L-Type) |      |   |
| 1        | 3                 | OUT  | Regulator Output Pin. It is recommended to use an output capacitor with effective capacitance of 1 $\mu$ F. The capacitor should be located very close to this pin. |
| 2        | 1                 | GND  | Ground.   |
| 3        | 2                 | IN   | Input Voltage Supply Pin. It is recommended to use a 1 $\mu$ F or larger ceramic capacitor from IN pin to ground.   |

**ELECTRICAL CHARACTERISTICS**(V<sub>IN</sub> = V<sub>OUT (NOMINAL)</sub> + 0.5V or 2.5V, whichever is greater, T<sub>A</sub> = +25°C, unless otherwise noted.)

| PARAMETER                      | SYMBOL             | CONDITIONS  | MIN       | TYP   | MAX   | UNITS             |    |
|--------------------------------|--------------------|---|-----------|-------|-------|-------------------|----|
| Input Voltage                  | V <sub>IN</sub>    |   | 2.5       |       | 5.5   | V                 |    |
| Output Voltage Accuracy        |                    | I <sub>OUT</sub> = 0.1mA  | -2.5      |       | 2.5   | %                 |    |
| Maximum Output Current         |                    |   | 300       |       |       | mA                |    |
| Current Limit                  | I <sub>LIM</sub>   |   | 310       | 500   |       | mA                |    |
| Ground Pin Current             | I <sub>Q</sub>     | No load, EN = 2V  |           | 100   | 200   | μA                |    |
| Dropout Voltage <sup>(1)</sup> |                    | I <sub>OUT</sub> = 1mA  |           | 0.9   |       | mV                |    |
|                                |                    | I <sub>OUT</sub> = 300mA  |           | 270   | 400   |                   |    |
| Line Regulation                | ΔV <sub>LNR</sub>  | V <sub>IN</sub> = 2.5V or (V <sub>OUT</sub> + 0.5V) to 5.5V, I <sub>OUT</sub> = 1mA         |           | 0.02  | 0.05  | %/V               |    |
| Load Regulation                | ΔV <sub>LDR</sub>  | I <sub>OUT</sub> = 0.1mA to 300mA, C <sub>OUT</sub> = 1μF, V <sub>OUT</sub> > 2V            |           | 0.002 | 0.005 | %/mA              |    |
|                                |                    | I <sub>OUT</sub> = 0.1mA to 300mA, C <sub>OUT</sub> = 1μF, V <sub>OUT</sub> ≤ 2V            |           | 0.004 | 0.008 |                   |    |
| Output Voltage Noise           | e <sub>n</sub>     | f = 10Hz to 100kHz, C <sub>OUT</sub> = 10μF   |           | 140   |       | μV <sub>RMS</sub> |    |
| Power Supply Rejection Ratio   | PSRR               | I <sub>OUT</sub> = 50mA, C <sub>OUT</sub> = 1μF,<br>V <sub>IN</sub> = V <sub>OUT</sub> + 1V | f = 217Hz |       | 72    |                   | dB |
|                                |                    |   | f = 1kHz  |       | 72    |                   | dB |
| <b>THERMAL PROTECTION</b>      |                    |   |           |       |       |                   |    |
| Thermal Shutdown Temperature   | T <sub>SHDN</sub>  |   |           | 150   |       | °C                |    |
| Thermal Shutdown Hysteresis    | ΔT <sub>SHDN</sub> |   |           | 15    |       | °C                |    |

## NOTE:

1. The dropout voltage is defined as V<sub>IN</sub> - V<sub>OUT</sub>, when V<sub>OUT</sub> is 100mV below the value of V<sub>OUT</sub> for V<sub>IN</sub> = V<sub>OUT</sub> + 0.5V (only applicable for V<sub>OUT</sub> = +2.5V to +5.0V).

TYPICAL PERFORMANCE CHARACTERISTICS

$V_{IN} = V_{OUT(NOMINAL)} + 0.5V$  or  $2.5V$  (whichever is greater),  $C_{IN} = 1\mu F$ ,  $C_{OUT} = 1\mu F$ ,  $T_A = +25^\circ C$ , unless otherwise noted.

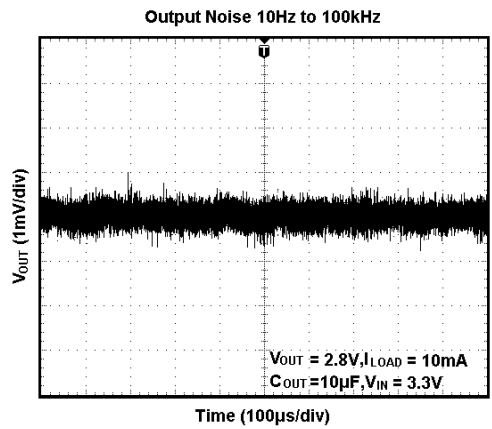
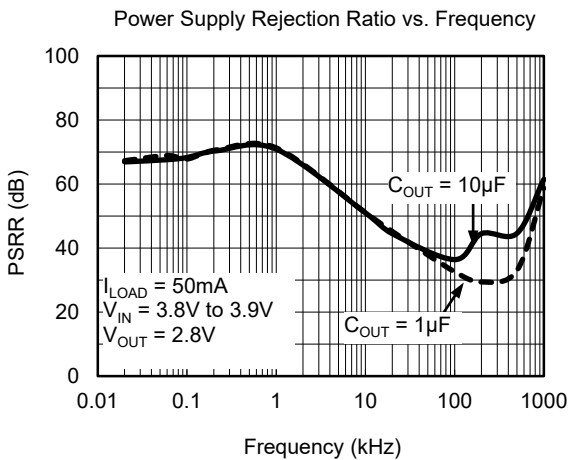
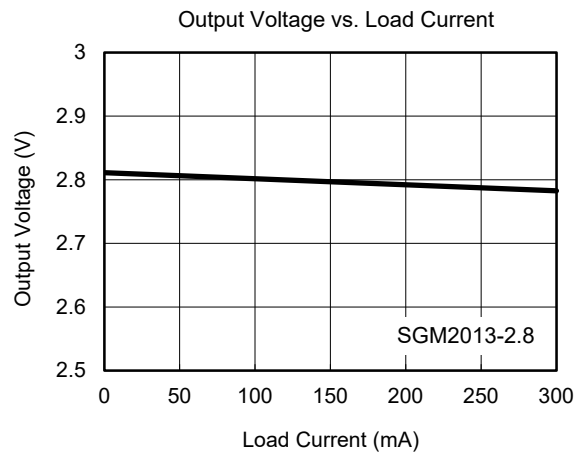
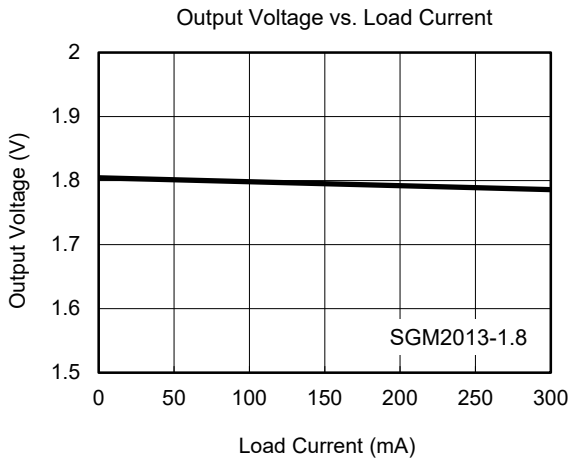
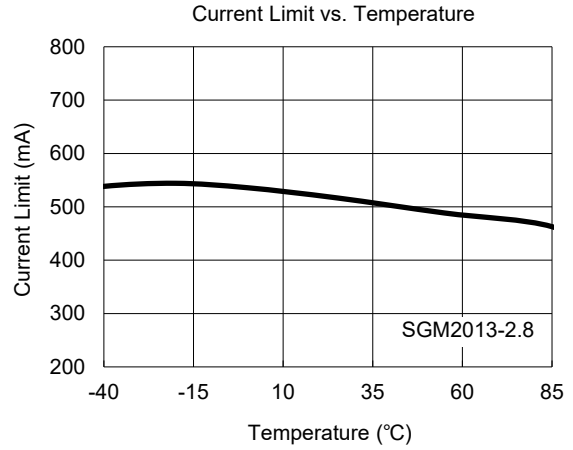
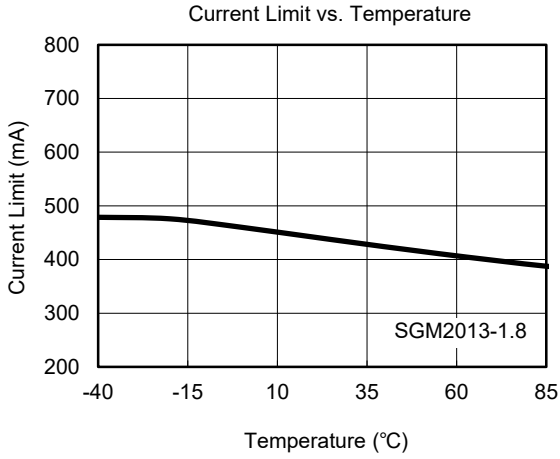

**TYPICAL PERFORMANCE CHARACTERISTICS (continued)**

$V_{IN} = V_{OUT(NOMINAL)} + 0.5V$  or  $2.5V$  (whichever is greater),  $C_{IN} = 1\mu F$ ,  $C_{OUT} = 1\mu F$ ,  $T_A = +25^\circ C$ , unless otherwise noted.

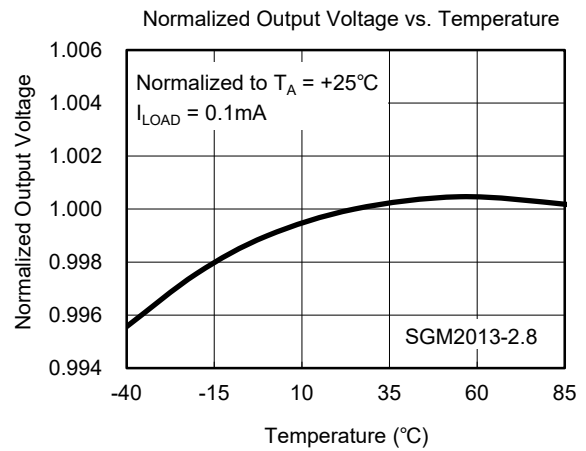
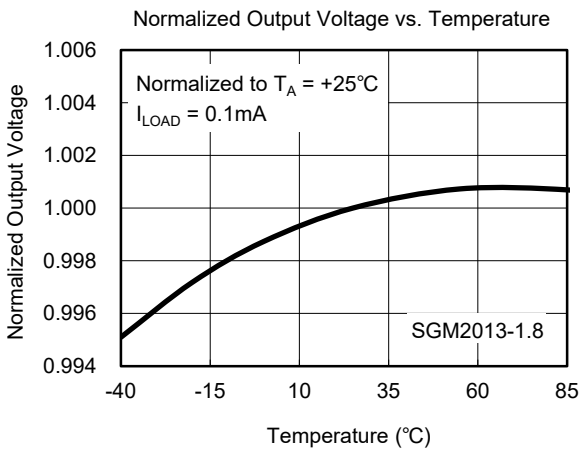
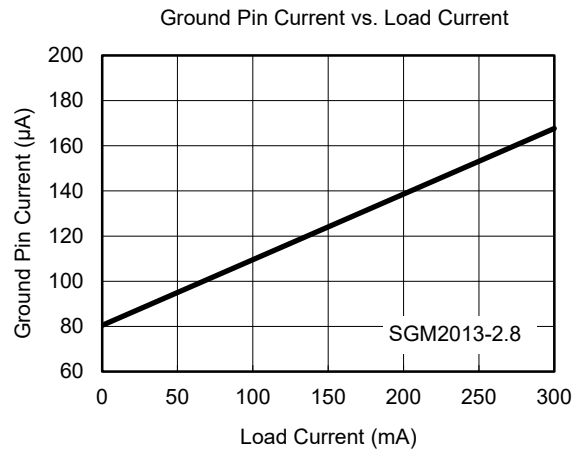
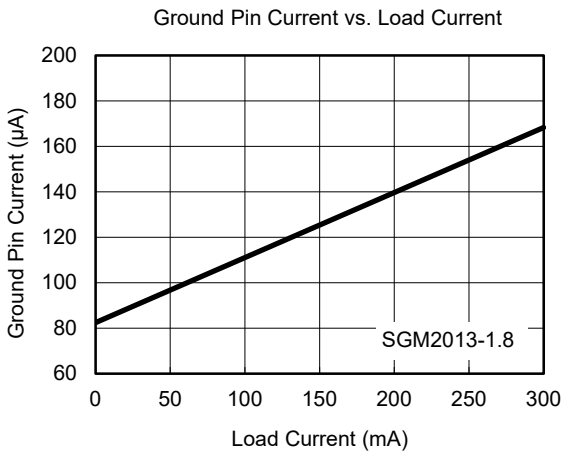
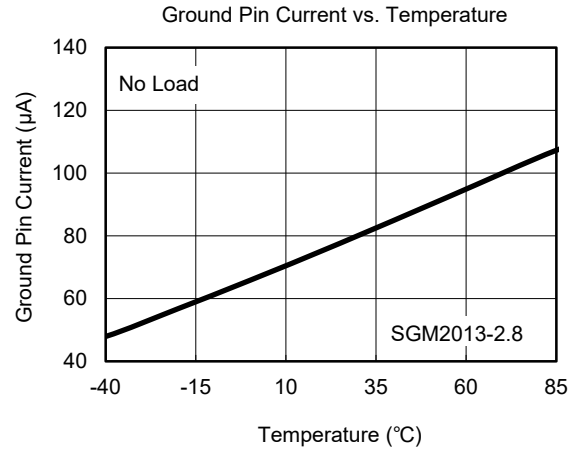
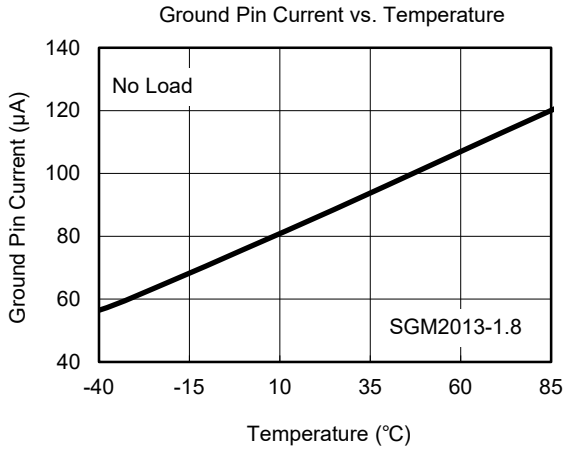

TYPICAL PERFORMANCE CHARACTERISTICS (continued)

$V_{IN} = V_{OUT(NOMINAL)} + 0.5V$  or  $2.5V$  (whichever is greater),  $C_{IN} = 1\mu F$ ,  $C_{OUT} = 1\mu F$ ,  $T_A = +25^\circ C$ , unless otherwise noted.

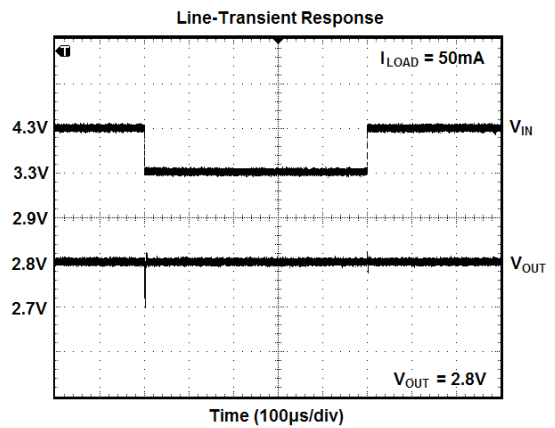
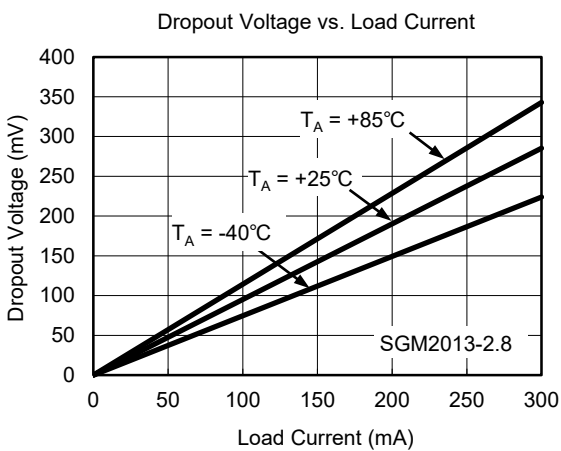
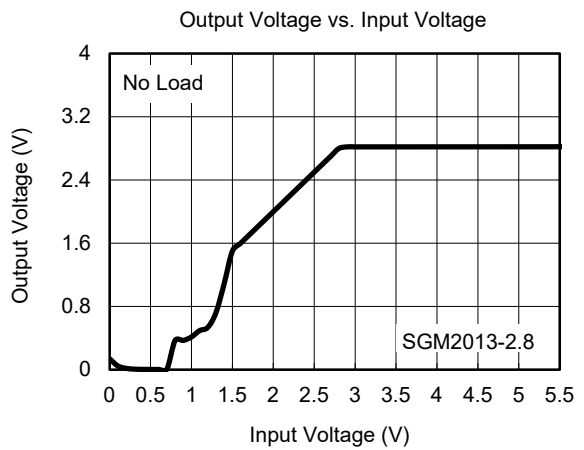
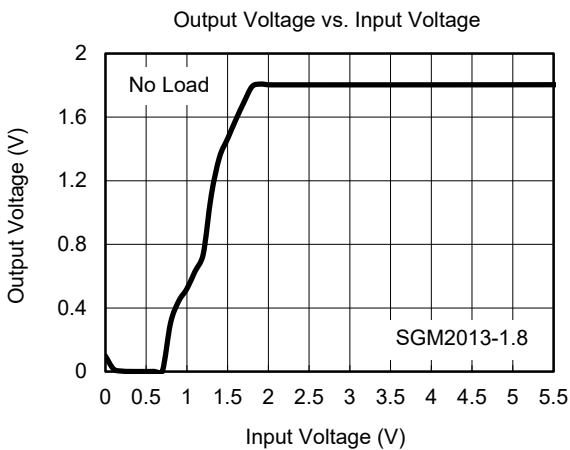
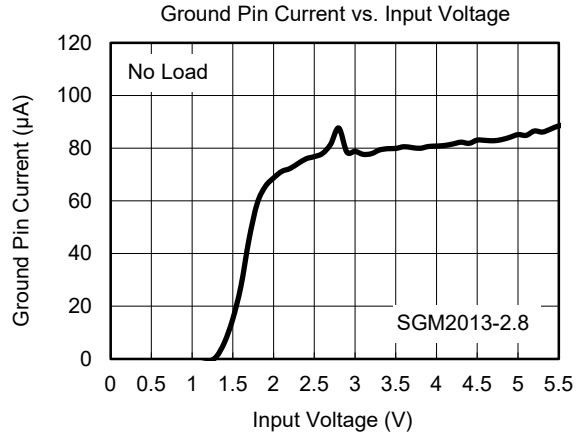
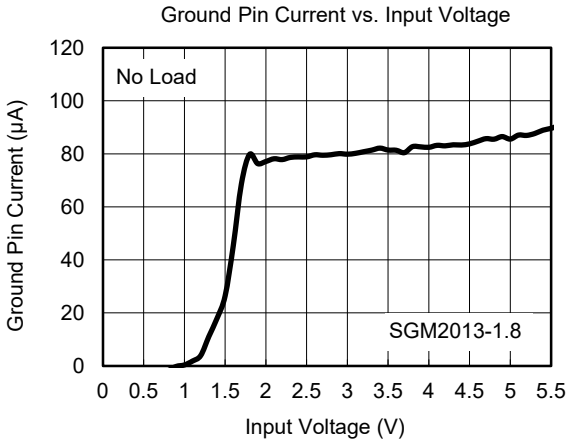

**TYPICAL PERFORMANCE CHARACTERISTICS (continued)**

$V_{IN} = V_{OUT(NOMINAL)} + 0.5V$  or  $2.5V$  (whichever is greater),  $C_{IN} = 1\mu F$ ,  $C_{OUT} = 1\mu F$ ,  $T_A = +25^\circ C$ , unless otherwise noted.

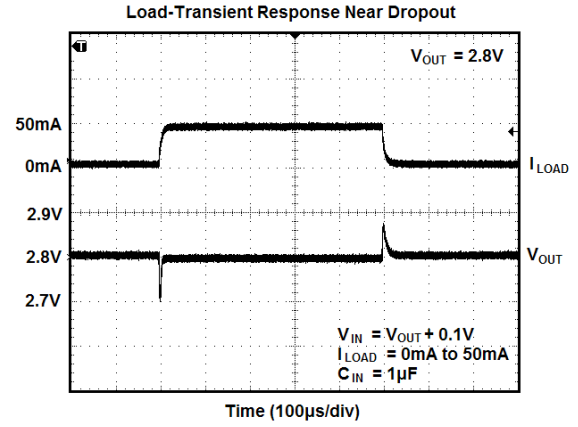
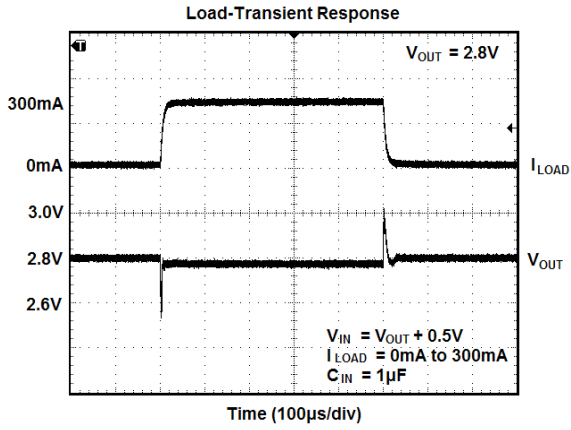



**APPLICATION INFORMATION**

The SGM2013 is a low power and low dropout LDO and provides 300mA output current. These features make the device a reliable solution to solve many challenging problems in the generation of clean and accurate power supply. The high performance also makes the SGM2013 useful in a variety of applications. The SGM2013 provides protection functions for output overload, output short-circuit condition and overheating.

**Input Capacitor Selection (C<sub>IN</sub>)**

The input decoupling capacitor is necessary to be connected as close as possible to the IN pin for ensuring the device stability. 1µF or larger X7R or X5R ceramic capacitor is selected to get good dynamic performance.

When V<sub>IN</sub> is required to provide large current instantaneously, a large effective input capacitor is required. Multiple input capacitors can limit the input tracking inductance. Adding more input capacitors is available to restrict the ringing and to keep it below the device absolute maximum ratings.

**Output Capacitor Selection (C<sub>OUT</sub>)**

The output decoupling capacitor should be located as close as possible to the OUT pin. 1µF or larger X7R or X5R ceramic capacitor is selected to get good dynamic performance. The minimum effective capacitance of C<sub>OUT</sub> that SGM2013 can remain stable is 0.5µF. For ceramic capacitor, temperature, DC bias and package

size will change the effective capacitance, so enough margin of C<sub>OUT</sub> must be considered in design. Larger capacitance and lower ESR C<sub>OUT</sub> will help improve the load transient response and increase the high frequency PSRR.

**Output Current Limit and Short-Circuit Protection**

When overload events happen, the output current is internally limited to 500mA (TYP). When the OUT pin is shorted to ground, the short-circuit protection will limit the output current.

**Thermal Shutdown**

The SGM2013 can detect the temperature of die. When the die temperature exceeds the threshold value of thermal shutdown, the SGM2013 will be in shutdown state and it will remain in this state until the die temperature decreases to +135°C.

**Layout Guidelines**

To get good PSRR, low output noise and high transient response performance, the input and output bypass capacitors must be placed as close as possible to the IN pin and OUT pin separately. V<sub>IN</sub> and V<sub>OUT</sub> had better use separate ground planes and these ground planes are single point connected to the GND pin.

**REVISION HISTORY**

NOTE: Page numbers for previous revisions may differ from page numbers in the current version.

**APRIL 2016 – REV.C.4 to REV.D**

Changed the Normalized Output Voltage vs. Temperature curves.....7

**PACKAGE OUTLINE DIMENSIONS**

**SOT-89-3**

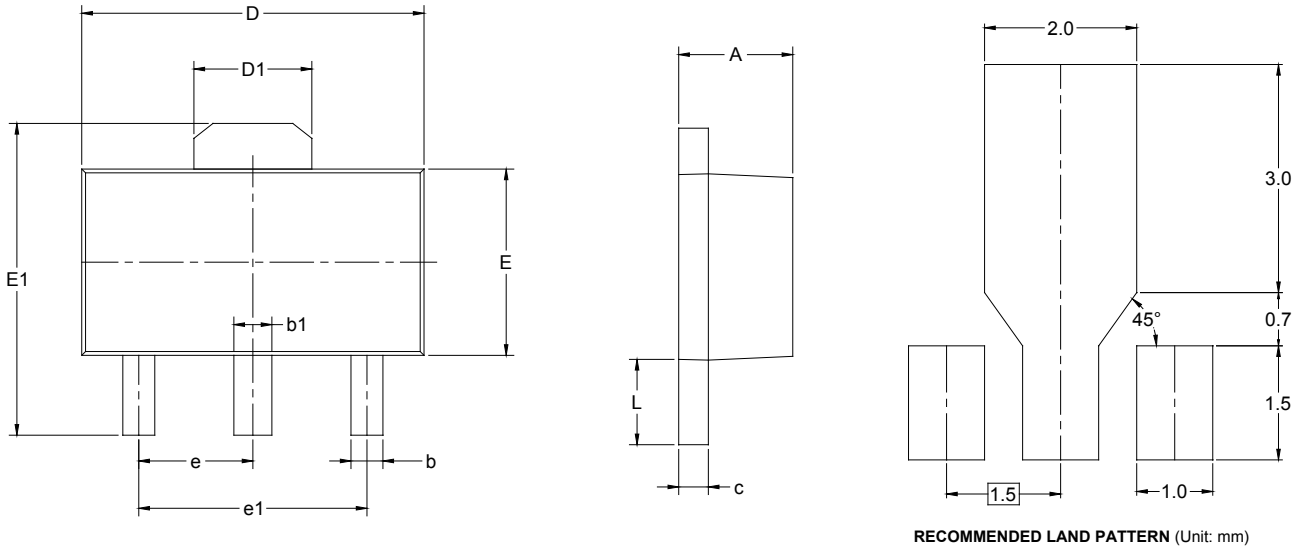

RECOMMENDED LAND PATTERN (Unit: mm)

| Symbol | Dimensions<br>In Millimeters |       | Dimensions<br>In Inches |       |
|--------|------------------------------|-------|-------------------------|-------|
|        | MIN                          | MAX   | MIN                     | MAX   |
| A      | 1.400                        | 1.600 | 0.055                   | 0.063 |
| b      | 0.320                        | 0.520 | 0.013                   | 0.020 |
| b1     | 0.400                        | 0.580 | 0.016                   | 0.023 |
| c      | 0.350                        | 0.440 | 0.014                   | 0.017 |
| D      | 4.400                        | 4.600 | 0.173                   | 0.181 |
| D1     | 1.550 REF                    |       | 0.061 REF               |       |
| E      | 2.300                        | 2.600 | 0.091                   | 0.102 |
| E1     | 3.940                        | 4.250 | 0.155                   | 0.167 |
| e      | 1.500 TYP                    |       | 0.060 TYP               |       |
| e1     | 3.000 TYP                    |       | 0.118 TYP               |       |
| L      | 0.900                        | 1.200 | 0.035                   | 0.047 |

TAPE AND REEL INFORMATION

REEL DIMENSIONS



TAPE DIMENSIONS



NOTE: The picture is only for reference. Please make the object as the standard.

KEY PARAMETER LIST OF TAPE AND REEL

| Package Type | Reel Diameter | Reel Width W1 (mm) | A0 (mm) | B0 (mm) | K0 (mm) | P0 (mm) | P1 (mm) | P2 (mm) | W (mm) | Pin1 Quadrant |
|--------------|---------------|--------------------|---------|---------|---------|---------|---------|---------|--------|---------------|
| SOT-89-3     | 7"            | 13.2               | 4.85    | 4.45    | 1.85    | 4.0     | 8.0     | 2.0     | 12.0   | Q3            |

DD0001

# PACKAGE INFORMATION

## CARTON BOX DIMENSIONS



NOTE: The picture is only for reference. Please make the object as the standard.

## KEY PARAMETER LIST OF CARTON BOX

| Reel Type   | Length (mm) | Width (mm) | Height (mm) | Pizza/Carton |
|-------------|-------------|------------|-------------|--------------|
| 7" (Option) | 368         | 227        | 224         | 8            |
| 7"          | 442         | 410        | 224         | 18           |

DD0002