

Features

- * Protects one data or power line
- * Operating voltage: $\pm 5.5V$
- * Ultra low clamping voltage
- * Complies with following standards:
 - IEC 61000-4-2 (ESD) immunity test
 - Air discharge: $\pm 20kV$
 - Contact discharge: $\pm 15kV$
 - IEC61000-4-5 (SURGE) 2A (8/20us)

Mechanical Characteristics

- * Package: SOT5x3
- * Ultra low leakage: nA level
- * Case Material: “Green” Molding Compound.
- * UL Flammability Classification Rating 94V-0
- * Moisture Sensitivity: Level 3 per J-STD-020
- * Shipping Qty :4000/7Inch Tape & Reel

Applications

- * Mobile Phones and Accessories
- * Battery Protection
- * USB VBus
- * Power Line Protection
- * Hand Held Portable Applications

Dimensions and Pin Configuration

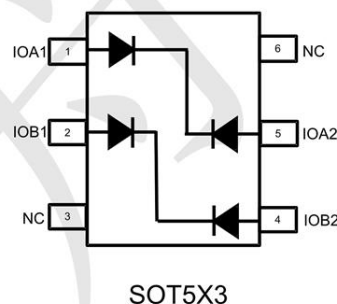

Marking: DUH

Absolute Maximum Ratings (Tamb=25°C unless otherwise specified)

Parameter	Symbol	Value	Unit
ESD per IEC 61000-4-2 (Air)	VESD	±20	kV
ESD per IEC 61000-4-2 (Contact)		±15	
Operating Temperature Range	TJ	-55 to +125	°C
Storage Temperature Range	Tstg	-55 to +150	°C

Electrical Characteristics (TA=25°C unless otherwise specified)

Parameter	Symbol	Test Condition	Min	Typ	Max	Unit
Reverse Working Voltage	V _{RWM}				5.5	V
Breakdown Voltage	V _{BR}	I _T = 1mA(Pin1-Pin2)	6.5		9.5	V
Reverse Leakage Current	I _R	V _{RWM} = 5.0V(Pin2-Pin1)			0.08	μA
Clamping Voltage	V _C	I _{PP} = 1A (8 x 20us pulse)			9	V
Clamping Voltage	V _C	I _{PP} = 2A (8 x 20us pulse)			15	V
Junction Capacitance	C _J	V _R = 0V, f = 1MHz		0.6	1.0	pF

Typical Performance Characteristics ($T_A=25^\circ\text{C}$ unless otherwise Specified)

Fig1. 8/20 μs Pulse Waveform

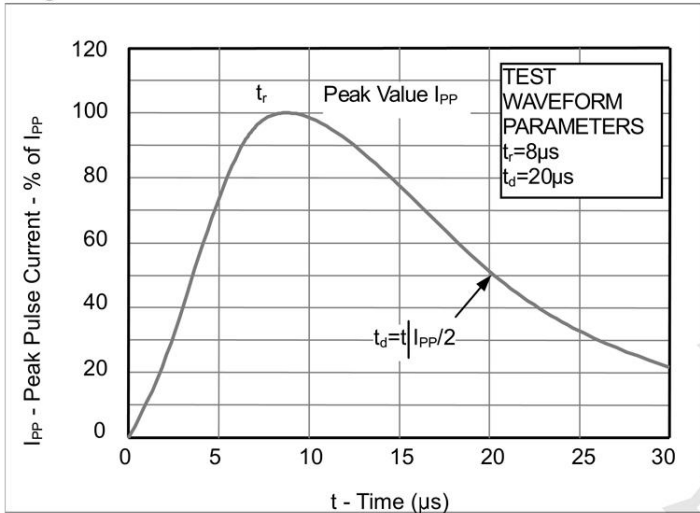

Fig2. ESD Pulse Waveform (according to IEC 61000-4-2)

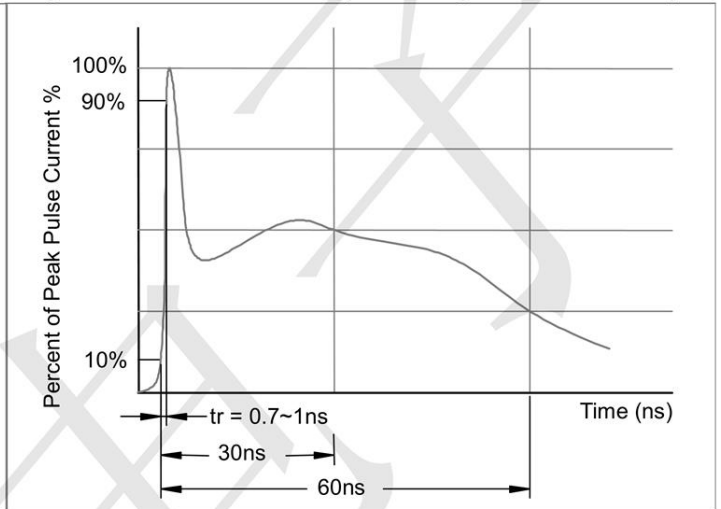
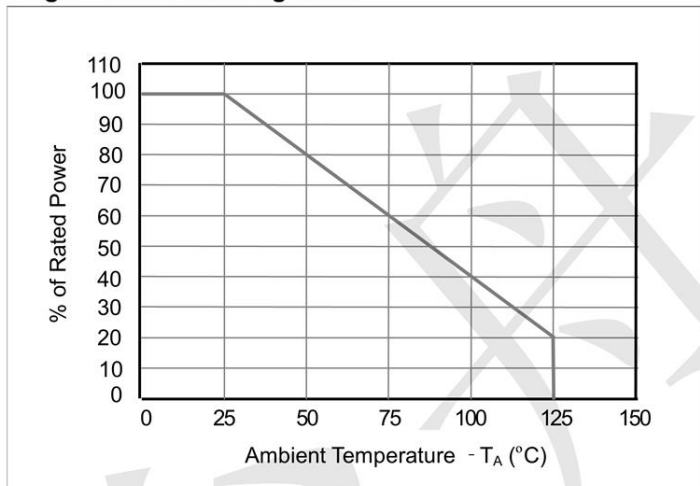
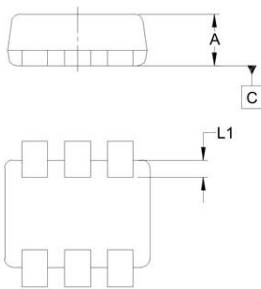
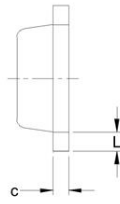
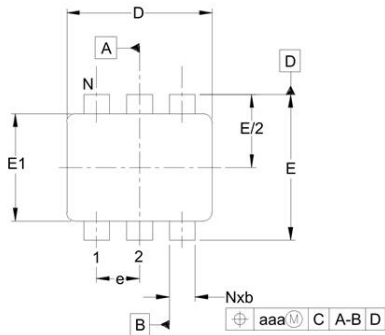

Fig3. Power Derating Curve



Outline Drawing - SOT-5X3



DIM	INCHES			MILLIMETERS		
	MIN	NOM	MAX	MIN	NOM	MAX
A	.019	-	.024	0.50	-	0.60
b	.005	-	.012	0.15	-	0.30
c	.003	-	.007	0.10	-	0.18
D	.059	.063	.067	1.50	1.60	1.70
E	.061	.063	.067	1.55	1.60	1.70
E1	.043	.047	.049	1.10	1.20	1.25
e	.020 BSC			0.50 BSC		
L	.003	.008	.012	0.10	0.20	0.30
L1	.003	.006	.008	0.10	0.15	0.20
N	6			6		
aaa	.004			0.10		

Land Pattern -SOT-5X3

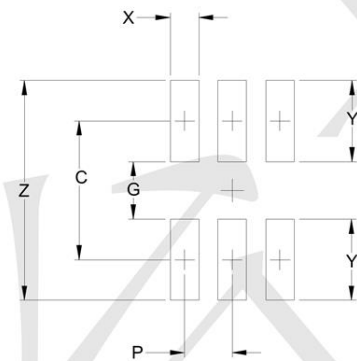

DIM	DIMENSIONS	
	INCHES	MILLIMETERS
C	(.057)	(1.45)
P	.020	0.50
G	.024	0.60
X	.012	0.30
Y	.033	0.85
Z	.090	2.30