

Product Summary

- 20V, 3.5A, $R_{DS(ON)} = 40m\Omega$ @ $V_{GS} = 4.5V$.
 $R_{DS(ON)} = 50m\Omega$ @ $V_{GS} = 2.5V$.
- -20V, -2.8A, $R_{DS(ON)} = 85m\Omega$ @ $V_{GS} = -4.5V$.
 $R_{DS(ON)} = 100m\Omega$ @ $V_{GS} = -2.5V$.

Application

- DC-DC Converters.
- Load Switch.
- Power Management.

Package and Pin Configuration

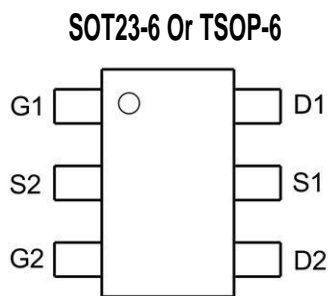

Circuit diagram

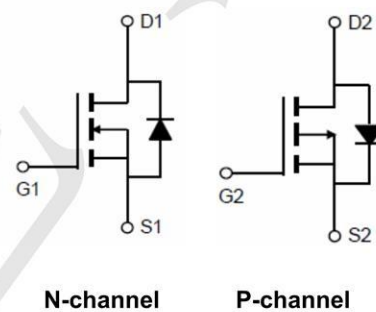

Marking:

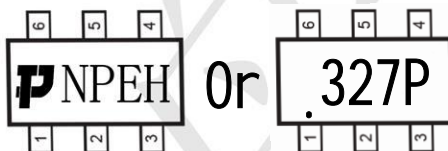

Absolute Maximum Ratings ($T_A=25^{\circ}C$ unless otherwise noted)

Parameter	Symbol	N-Channel	P-Channel	Units
Drain-Source Voltage	V_{DS}	20	-20	V
Gate-Source Voltage	V_{GS}	± 12	± 12	V
Drain Current-Continuous	I_D	3.5	-2.8	A
Drain Current-Pulsed ^a	I_{DM}	14	10	A
Maximum Power Dissipation	P_D	1.14		W
Operating and Store Temperature Range	T_J, T_{stg}	-55 to 150		$^{\circ}C$

Thermal Characteristic

Parameter	Symbol	Limit	Units
Thermal Resistance, Junction-to-Ambient ^b	$R_{\theta JA}$	110	$^{\circ}C/W$

N-CH Electrical Characteristics (T_A=25°C unless otherwise noted)

Parameter	Symbol	Test Condition	Min	Typ	Max	Units
Off Characteristics						
Drain-Source Breakdown Voltage	BV _{DSS}	V _{GS} = 0V, I _D = 250μA	20			V
Zero Gate Voltage Drain Current	I _{DSS}	V _{DS} = 20V, V _{GS} = 0V			1	μA
Gate Body Leakage Current, Forward	I _{GSSF}	V _{GS} = 12V, V _{DS} = 0V			100	nA
Gate Body Leakage Current, Reverse	I _{GSSR}	V _{GS} = -12V, V _{DS} = 0V			-100	nA
On Characteristics^c						
Gate Threshold Voltage	V _{GS(th)}	V _{GS} = V _{DS} , I _D = 250μA	0.4		1.2	V
Static Drain-Source On-Resistance	R _{DS(on)}	V _{GS} = 4.5V, I _D = 3.5A		40	55	mΩ
		V _{GS} = 2.5V, I _D = 2.0A		50	80	mΩ
Dynamic Characteristics^d						
Input Capacitance	C _{iss}	V _{DS} = 10V, V _{GS} = 0V, f = 1.0 MHz		380		pF
Output Capacitance	C _{oss}			90		pF
Reverse Transfer Capacitance	C _{rss}			60		pF
Switching Characteristics^d						
Turn-On Delay Time	t _{d(on)}	V _{DD} = 10V, I _D = 3.5A, V _{GS} = 4.5V, R _{GEN} = 6Ω		16		ns
Turn-On Rise Time	t _r			16		ns
Turn-Off Delay Time	t _{d(off)}			32		ns
Turn-Off Fall Time	t _f			7		ns
Total Gate Charge	Q _g	V _{DS} = 10V, I _D = 3.5A, V _{GS} = 3.3V		3.6		nC
Gate-Source Charge	Q _{gs}			1.0		nC
Gate-Drain Charge	Q _{gd}			1.2		nC
Drain-Source Diode Characteristics and Maximum Ratings						
Drain-Source Diode Forward Current ^b	I _S				1	A
Drain-Source Diode Forward Voltage ^c	V _{SD}	V _{GS} = 0V, I _S = 1A			1.1	V

P-CH Electrical Characteristics (T_A=25°C unless otherwise noted)

Parameter	Symbol	Test Condition	Min	Typ	Max	Units
Off Characteristics						
Drain-Source Breakdown Voltage	BV _{DSS}	V _{GS} = 0V, I _D = -250μA	-20			V
Zero Gate Voltage Drain Current	I _{DSS}	V _{DS} = -16V, V _{GS} = 0V			-1	μA
Gate Body Leakage Current, Forward	I _{GSSF}	V _{GS} = 12V, V _{DS} = 0V			100	nA
Gate Body Leakage Current, Reverse	I _{GSSR}	V _{GS} = -12V, V _{DS} = 0V			-100	nA
On Characteristics^c						
Gate Threshold Voltage	V _{GS(th)}	V _{GS} = V _{DS} , I _D = -250μA	-0.4		-1.2	V
Static Drain-Source On-Resistance	R _{DS(on)}	V _{GS} = -4.5V, I _D = -2.5A		85	100	mΩ
		V _{GS} = -2.5V, I _D = -1.5A		100	145	mΩ
Dynamic Characteristics^d						
Input Capacitance	C _{iss}	V _{DS} = -10V, V _{GS} = 0V, f = 1.0 MHz		375		pF
Output Capacitance	C _{oss}			90		pF
Reverse Transfer Capacitance	C _{rss}			60		pF
Switching Characteristics^d						
Turn-On Delay Time	t _{d(on)}	V _{DD} = -10V, I _D = -2.5A, V _{GS} = -4.5V, R _{GEN} = 3Ω		17		ns
Turn-On Rise Time	t _r			17		ns
Turn-Off Delay Time	t _{d(off)}			27		ns
Turn-Off Fall Time	t _f			7		ns
Total Gate Charge	Q _g	V _{DS} = -10V, I _D = -2.0A, V _{GS} = -3.3V		2.9		nC
Gate-Source Charge	Q _{gs}			0.46		nC
Gate-Drain Charge	Q _{gd}			1.19		nC
Drain-Source Diode Characteristics and Maximum Ratings						
Drain-Source Diode Forward Current ^b	I _S				-1	A
Drain-Source Diode Forward Voltage ^c	V _{SD}	V _{GS} = 0V, I _S = -1A			-1.1	V

N- Channel Typical Electrical and Thermal Characteristics

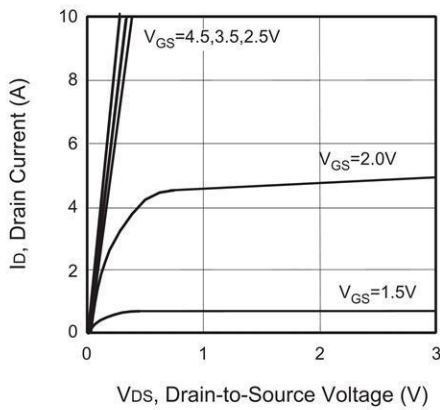

Figure 1. Output Characteristics

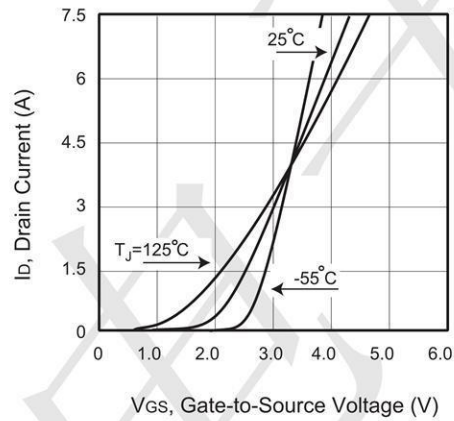

Figure 2. Transfer Characteristics

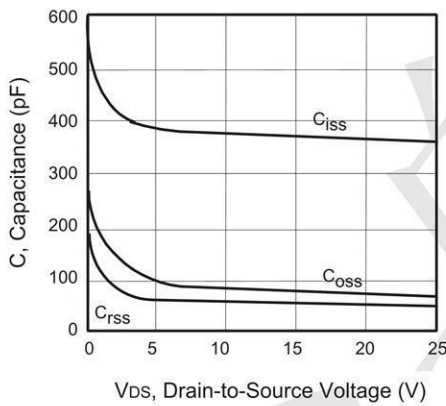

Figure 3. Capacitance

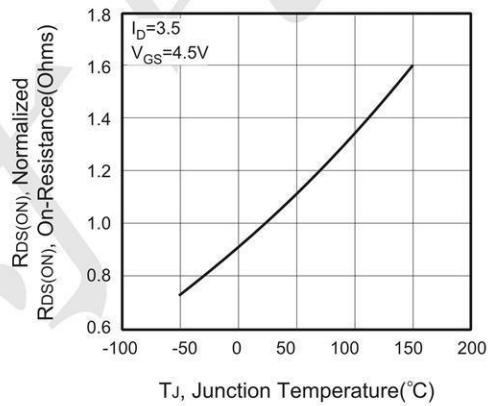

Figure 4. On-Resistance Variation with Temperature

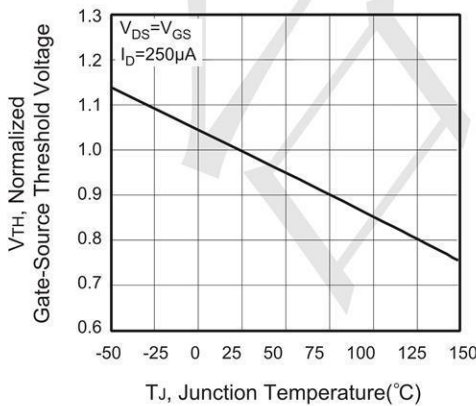

Figure 5. Gate Threshold Variation with Temperature

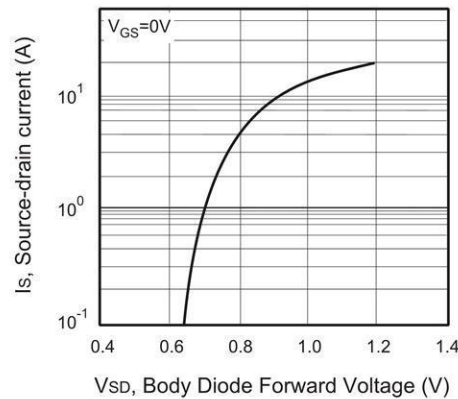

Figure 6. Body Diode Forward Voltage Variation with Source Current

P-CHANNEL

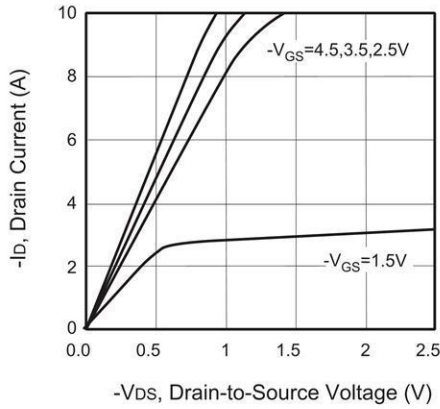

Figure 1. Output Characteristics

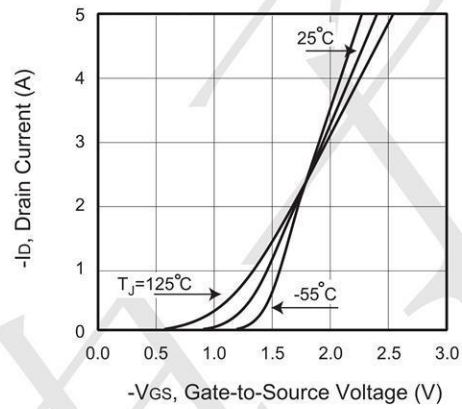

Figure 2. Transfer Characteristics

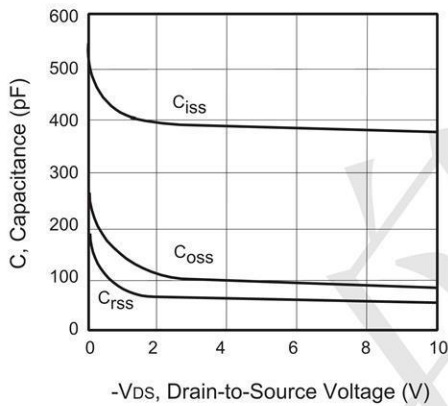

Figure 3. Capacitance

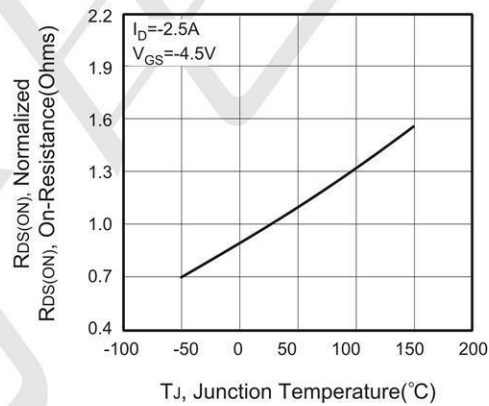

Figure 4. On-Resistance Variation with Temperature

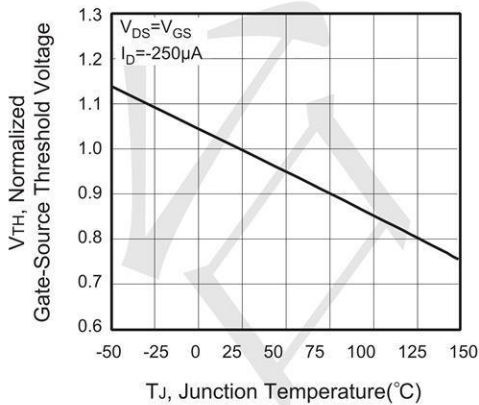

Figure 5. Gate Threshold Variation with Temperature

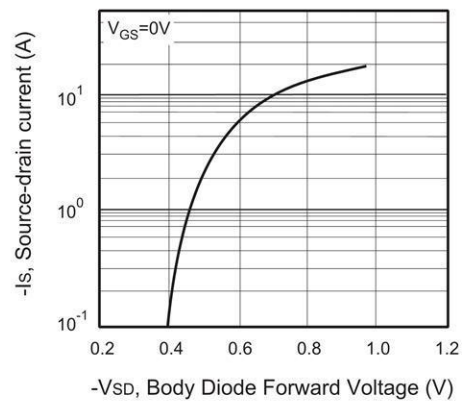

Figure 6. Body Diode Forward Voltage Variation with Source Current

N-CHANNEL

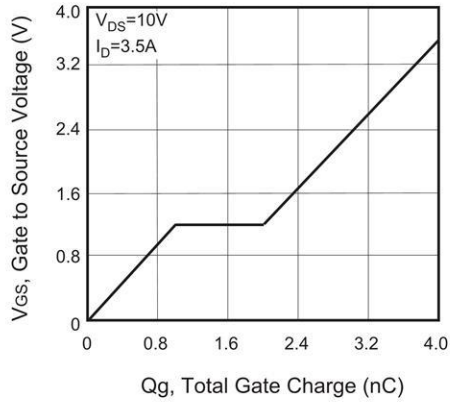

Figure 13. Gate Charge

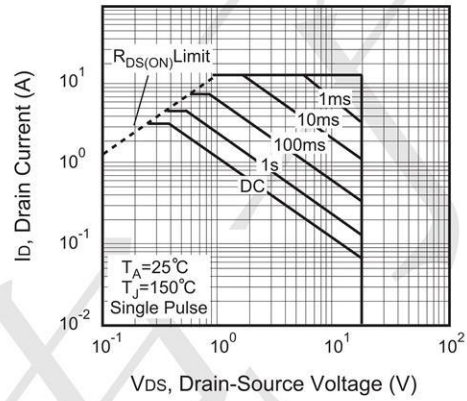

Figure 14. Maximum Safe Operating Area

P-CHANNEL

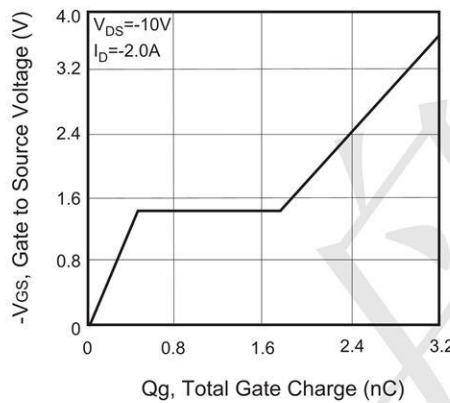

Figure 15. Gate Charge

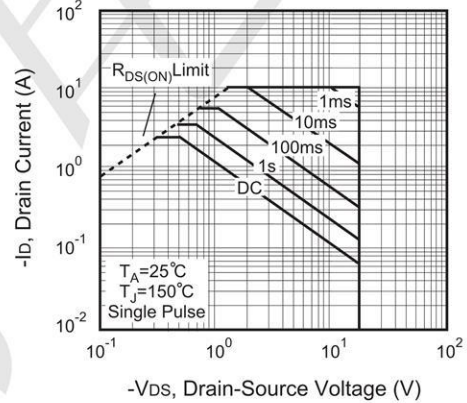

Figure 16. Maximum Safe Operating Area

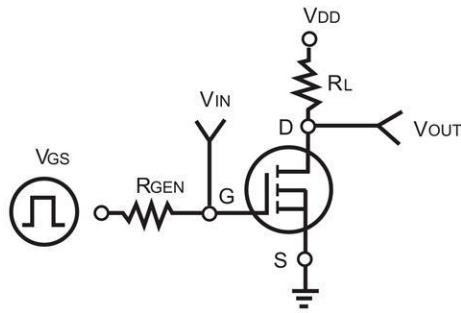

Figure 17. Switching Test Circuit

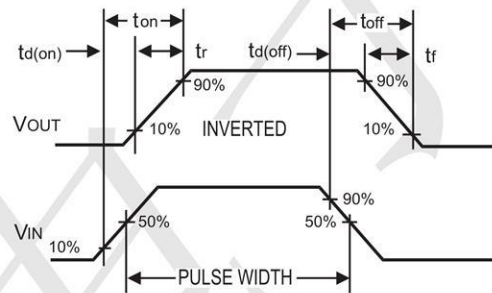

Figure 18. Switching Waveforms

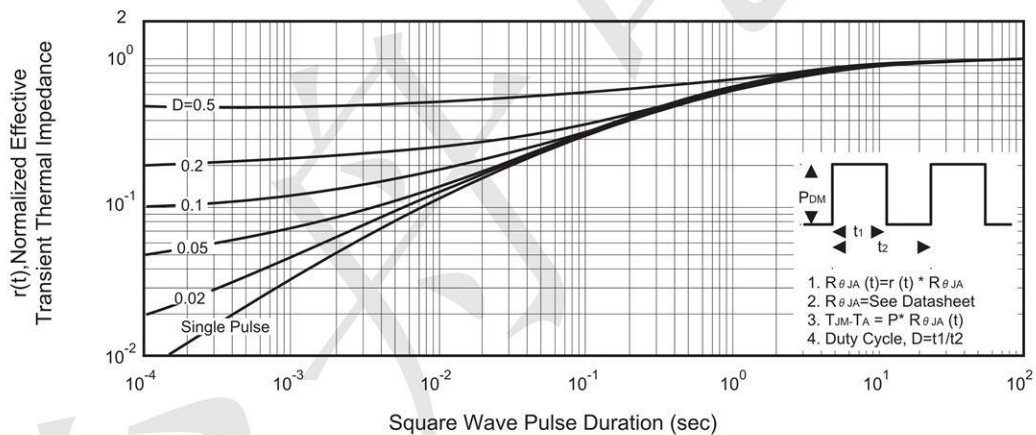
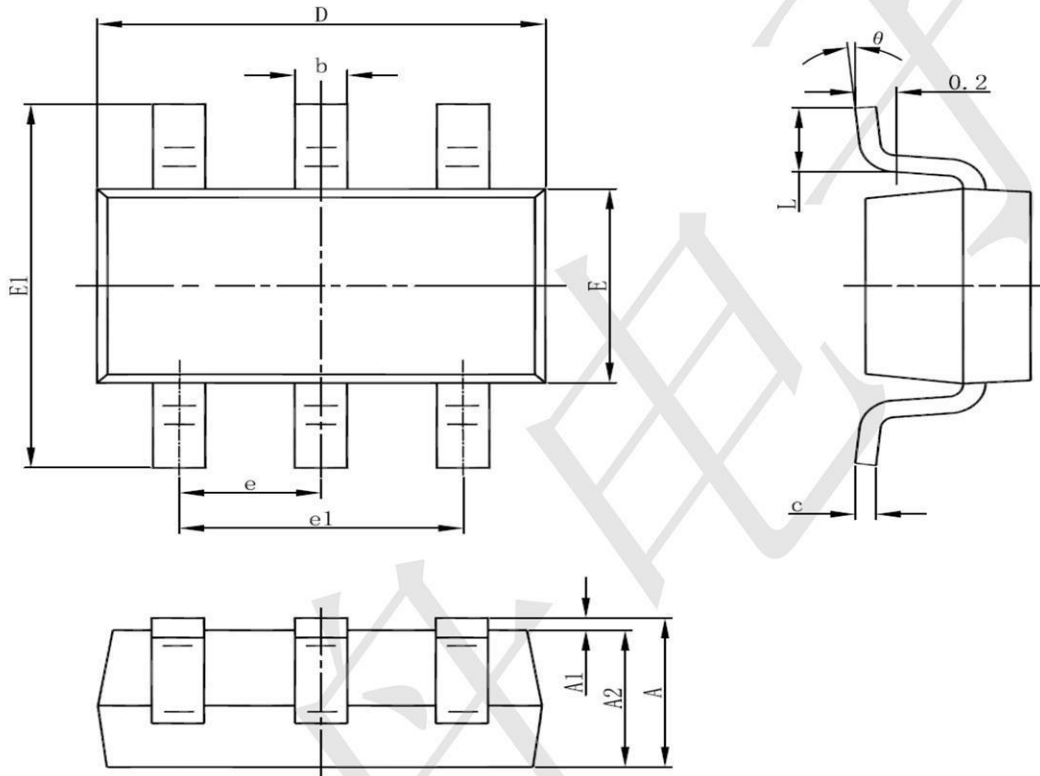

Figure 19. Normalized Thermal Transient Impedance Curve



SOT23-6 Package Information



Symbol	Dimensions In Millimeters		Dimensions In Inches	
	Min	Max	Min	Max
A	1.050	1.250	0.041	0.049
A1	0.000	0.100	0.000	0.004
A2	1.050	1.150	0.041	0.045
b	0.300	0.500	0.012	0.020
c	0.100	0.200	0.004	0.008
D	2.820	3.020	0.111	0.119
E	1.500	1.700	0.059	0.067
E1	2.650	2.950	0.104	0.116
e	0.950(BSC)		0.037(BSC)	
e1	1.800	2.000	0.071	0.079
L	0.300	0.600	0.012	0.024
θ	0°	8°	0°	8°