

Product Summary

- **N-Channel**
- $V_{DS} = 30V, I_D = 4A$
 $R_{DS(ON)} 30m\Omega @ V_{GS}=10V (Typ)$
 $R_{DS(ON)} 50m\Omega @ V_{GS}=-4.5V (Typ)$
- **P-Channel**
- $V_{DS} = -30V, I_D = 3A$
 $R_{DS(ON)} 45m\Omega @ V_{GS}=-10V (Typ)$
 $R_{DS(ON)} 85m\Omega @ V_{GS}=-4.5V (Typ)$

Application

- DC-DC Converters.
- Load Switch.
- Power Management.

Package and Pin Configuration

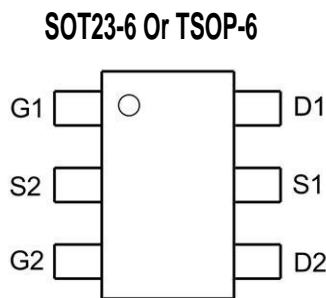

Circuit diagram

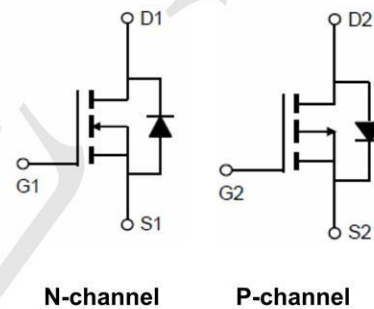

Marking:



Absolute Maximum Ratings ($T_A=25^\circ C$ unless otherwise noted)

Parameter	Symbol	N-Channel	P-Channel	Unit
Drain-Source Voltage	V_{DS}	30	-30	V
Gate-Source Voltage	V_{GS}	± 20	± 20	V
Continuous Drain Current	I_D	$T_A=25^\circ C$	4.0	-3.0
		$T_A=70^\circ C$	3	-2.1
Pulsed Drain Current (Note 1)	I_{DM}	20	-15	A
Maximum Power Dissipation	P_D	1.2		W
Operating Junction and Storage Temperature Range	T_J, T_{STG}	-55 To 150	-55 To 150	$^\circ C$

Thermal Characteristic

Thermal Resistance, Junction-to-Ambient (Note2)	$R_{\theta JA}$	N-Ch	104	$^\circ C/W$
Thermal Resistance, Junction-to-Ambient (Note2)	$R_{\theta JA}$	P-Ch	104	$^\circ C/W$

N-CH Electrical Characteristics (T_A=25°C unless otherwise noted)

Parameter	Symbol	Condition	Min	Typ	Max	Unit
Off Characteristics						
Drain-Source Breakdown Voltage	BV _{DSS}	V _{GS} =0V, I _D =250μA	30		-	V
Zero Gate Voltage Drain Current	I _{DSS}	V _{DS} =30V, V _{GS} =0V	-	-	1	μA
Gate-Body Leakage Current	I _{GSS}	V _{GS} =±20V, V _{DS} =0V	-	-	±100	nA
On Characteristics (Note 3)						
Gate Threshold Voltage	V _{GS(th)}	V _{DS} =V _{GS} , I _D =250μA	1.2	1.5	2.2	V
Drain-Source On-State Resistance	R _{DS(ON)}	V _{GS} =10V, I _D =4A		30	48	mΩ
		V _{GS} =4.5V, I _D =2A		50	90	mΩ
Forward Transconductance	g _{FS}	V _{DS} =5V, I _D =3.1A	-	4	-	S
Dynamic Characteristics (Note 4)						
Input Capacitance	C _{ISS}	V _{DS} =15V, V _{GS} =0V, F=1.0MHz	-	210	-	PF
Output Capacitance	C _{OSS}		-	35	-	PF
Reverse Transfer Capacitance	C _{rss}		-	23	-	PF
Switching Characteristics (Note 4)						
Turn-on Delay Time	t _{d(on)}	V _{DD} =15V, R _L =3Ω V _{GS} =10V, R _{GEN} =6Ω	-	4.5	-	nS
Turn-on Rise Time	t _r		-	1.5	-	nS
Turn-Off Delay Time	t _{d(off)}		-	18.5	-	nS
Turn-Off Fall Time	t _f		-	15.5	-	nS
Total Gate Charge	Q _g	V _{DS} =15V, I _D =3.5A, V _{GS} =10V	-	5	-	nC
Gate-Source Charge	Q _{gs}		-	0.55	-	nC
Gate-Drain Charge	Q _{gd}		-	1	-	nC
Drain-Source Diode Characteristics						
Diode Forward Voltage (Note 3)	V _{SD}	V _{GS} =0V, I _S =3.5A	-	0.8	1.2	V
Diode Forward Current (Note 2)	I _S		-	-	4	A

P-CH Electrical Characteristics (T_A=25°C unless otherwise noted)

Parameter	Symbol	Condition	Min	Typ	Max	Unit
Off Characteristics						
Drain-Source Breakdown Voltage	BV _{DSS}	V _{GS} =0V, I _D =-250μA	-30	-33	-	V
Zero Gate Voltage Drain Current	I _{DSS}	V _{DS} =-30V, V _{GS} =0V	-	-	-1	μA
Gate-Body Leakage Current	I _{GSS}	V _{GS} =±20V, V _{DS} =0V	-	-	±100	nA
On Characteristics (Note 3)						
Gate Threshold Voltage	V _{GS(th)}	V _{DS} =V _{GS} , I _D =-250μA	-1	-1.6	-2.5	V
Drain-Source On-State Resistance	R _{DS(on)}	V _{GS} =-10V, I _D =-2.7A	-	45	65	mΩ
		V _{GS} =-4.5V, I _D =-2A	-	85	100	mΩ
Forward Transconductance	g _{FS}	V _{DS} =-10V, I _D =-2.7A		2	-	S
Dynamic Characteristics (Note 4)						
Input Capacitance	C _{iss}	V _{DS} =-15V, V _{GS} =0V, F=1.0MHz	-	199	-	PF
Output Capacitance	C _{oss}		-	47	-	PF
Reverse Transfer Capacitance	C _{rss}		-	28	-	PF
Switching Characteristics (Note 4)						
Turn-on Delay Time	t _{d(on)}	V _{DD} =-15V, R _L =15Ω V _{GS} =-10V, R _{GEN} =6Ω	-	8	-	nS
Turn-on Rise Time	t _r		-	5	-	nS
Turn-Off Delay Time	t _{d(off)}		-	12	-	nS
Turn-Off Fall Time	t _f		-	4	-	nS
Total Gate Charge	Q _g	V _{DS} =-15V, I _D =-2.7A, V _{GS} =-10V	-	5	-	nC
Gate-Source Charge	Q _{gs}		-	0.7	-	nC
Gate-Drain Charge	Q _{gd}		-	1.1	-	nC
Drain-Source Diode Characteristics						
Diode Forward Voltage (Note 3)	V _{SD}	V _{GS} =0V, I _S =-2.7A	-	-	-1.2	V

N- Channel Typical Electrical and Thermal Characteristics

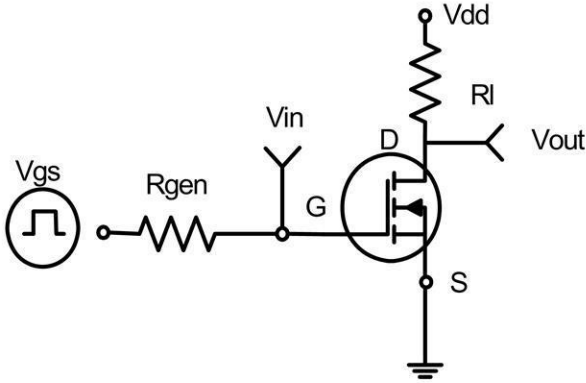

Figure 1: Switching Test Circuit

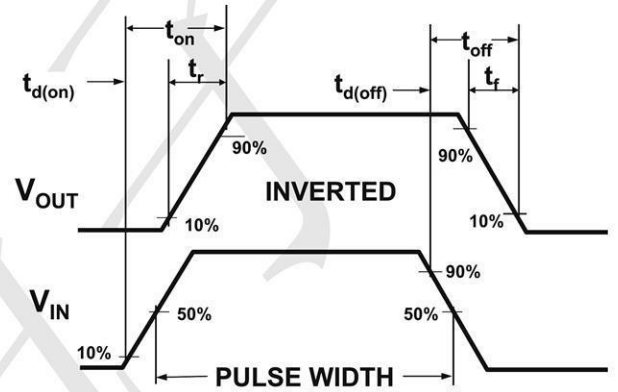

Figure 2: Switching Waveforms

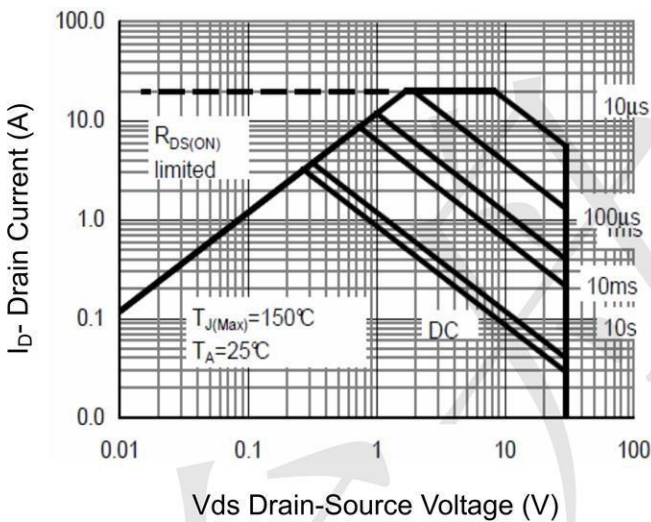

Figure 3 Safe Operation Area

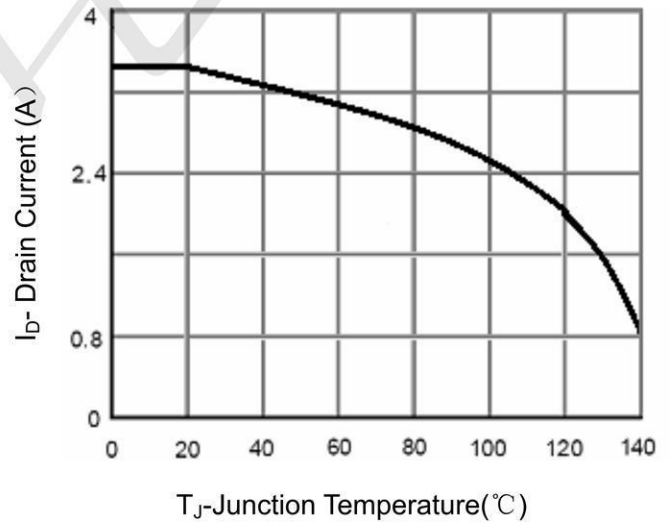

Figure 4 Drain Current

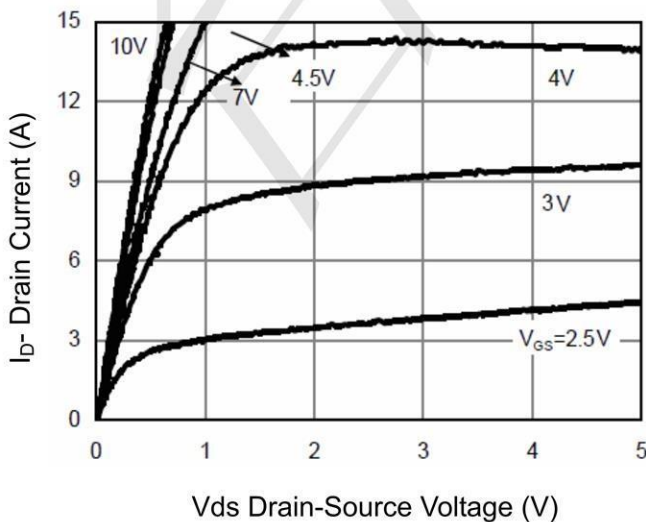

Figure 5 Output Characteristics

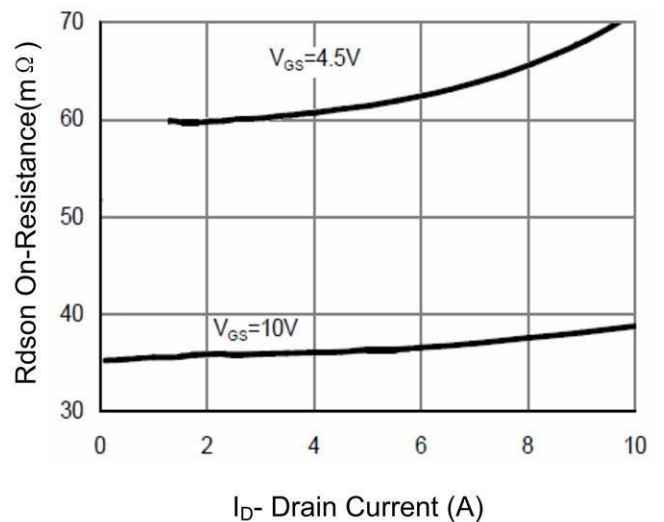

Figure 6 Drain-Source On-Resistance

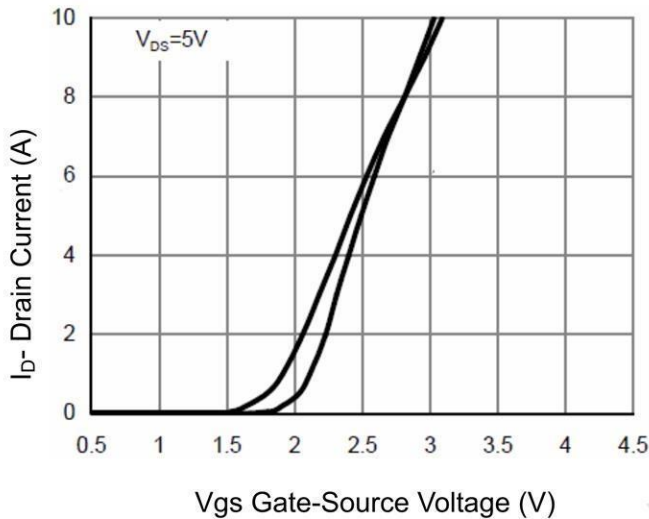

Figure 7 Transfer Characteristics

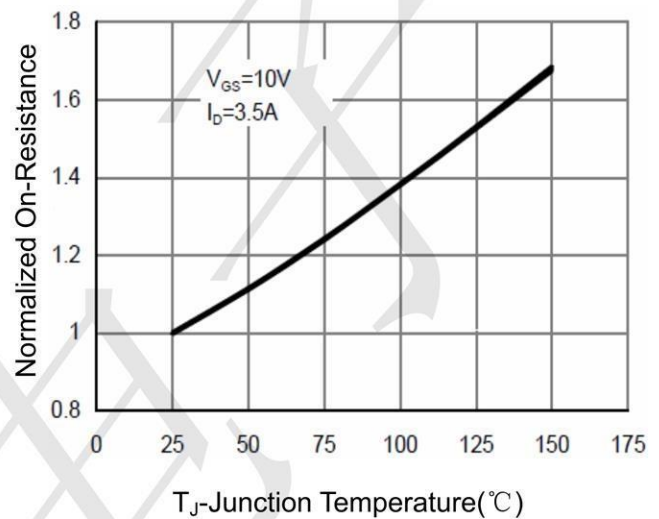

Figure 8 Drain-Source On-Resistance

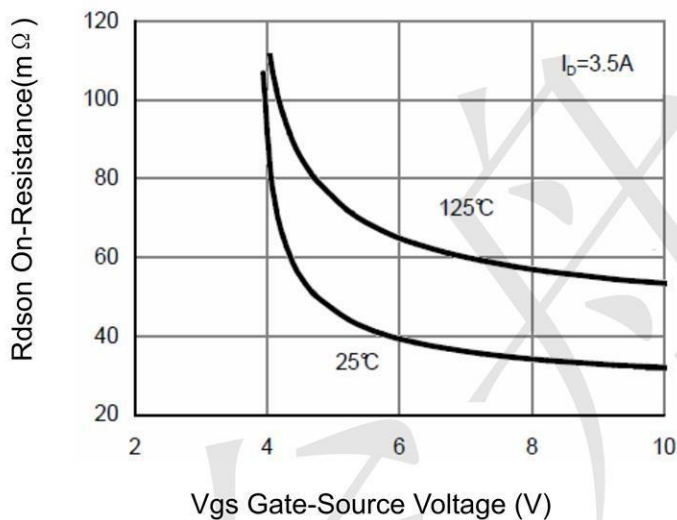

Figure 9 Rdson vs Vgs

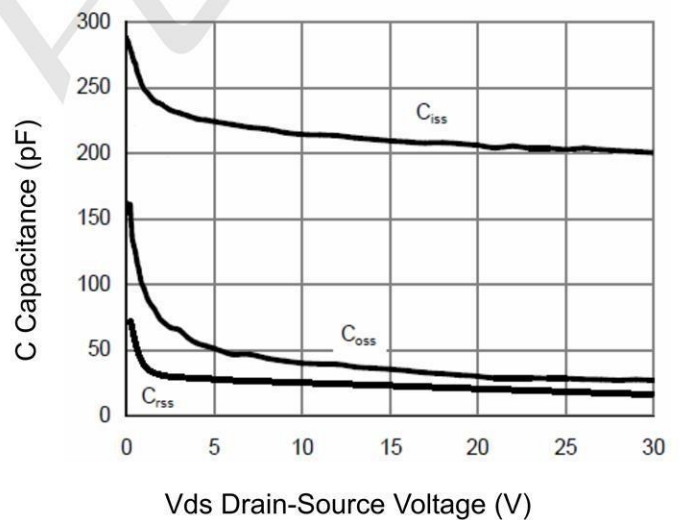

Figure 10 Capacitance vs Vds

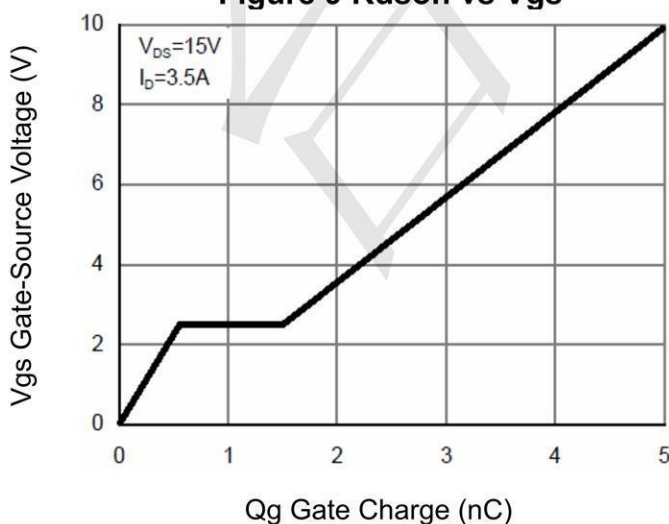

Figure 11 Gate Charge

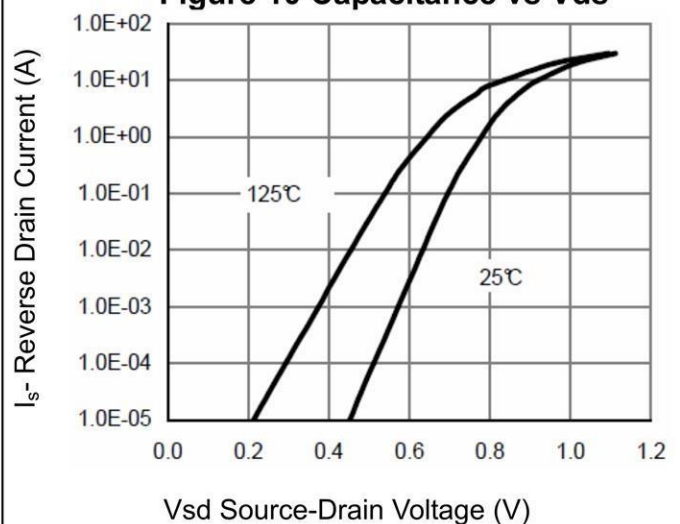

Figure 12 Source- Drain Diode Forward

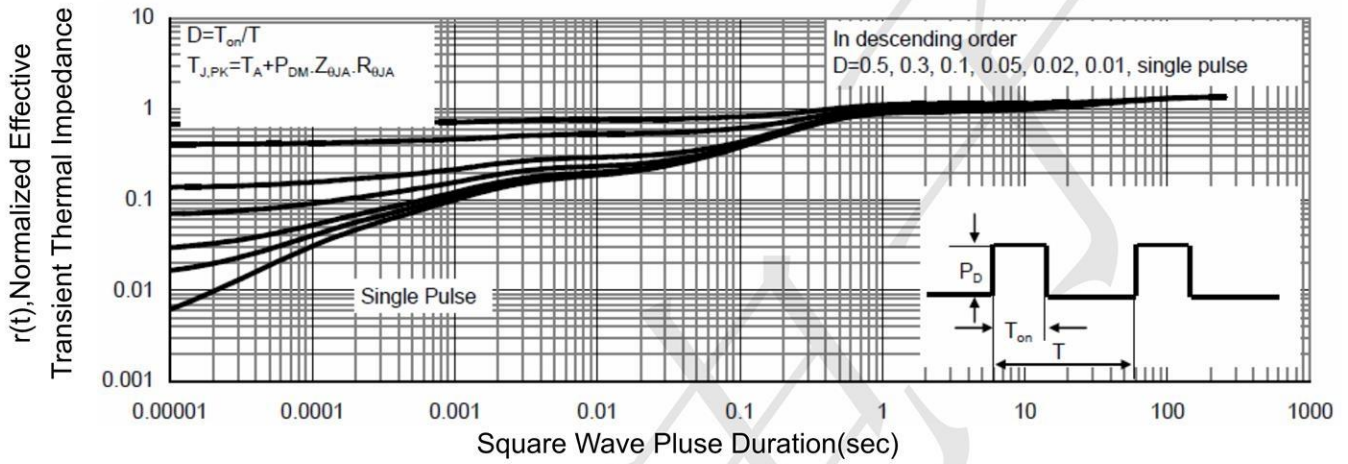

Figure 13 Normalized Maximum Transient Thermal Impedance

P- Channel Typical Electrical and Thermal Characteristics

www.sot23.com.tw

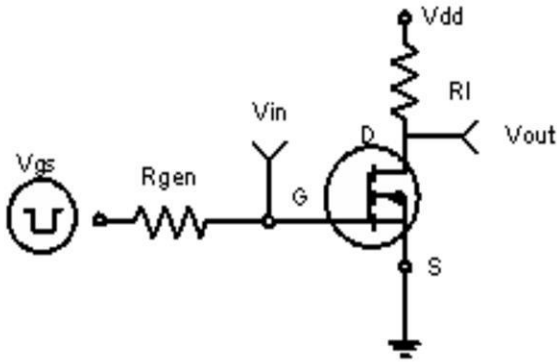

Figure 1: Switching Test Circuit

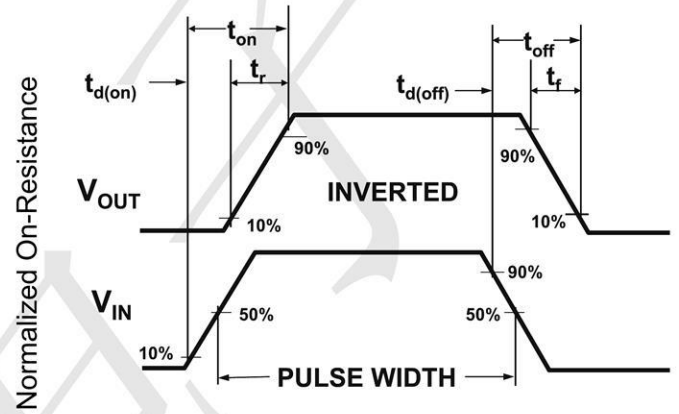

Figure 2: Switching Waveforms

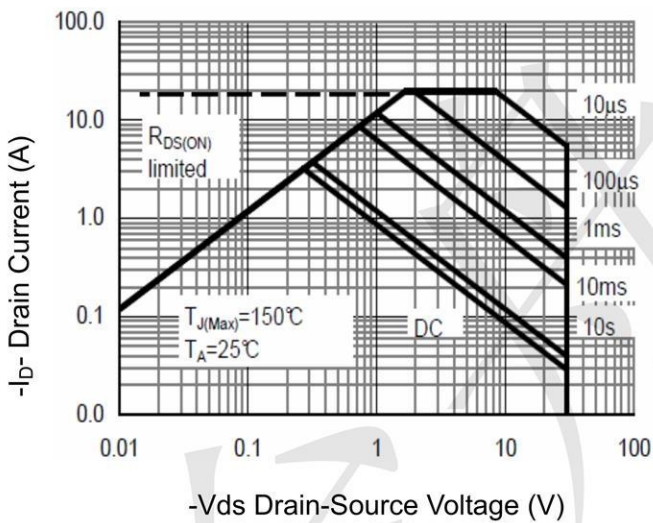

Figure 3 Safe Operation Area

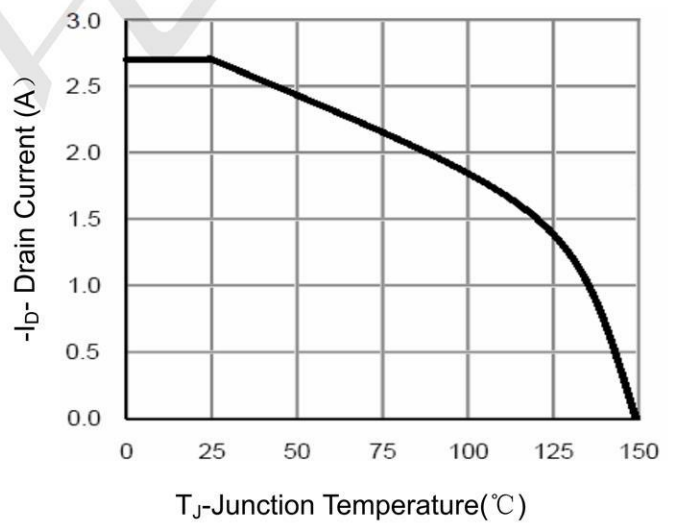

Figure 4 Drain Current

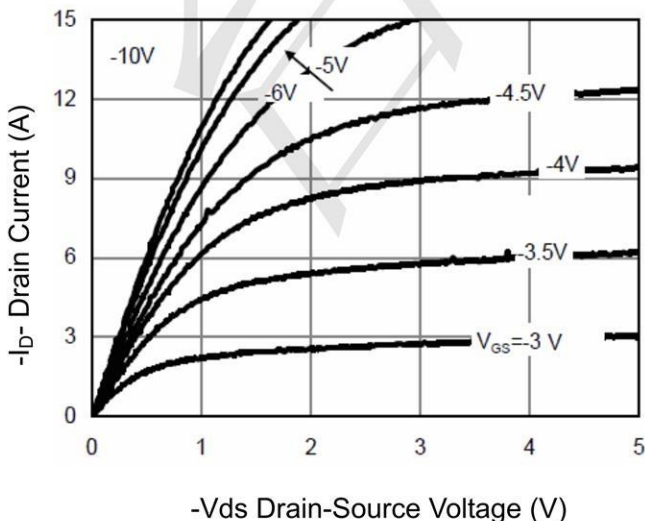

Figure 5 Output Characteristics

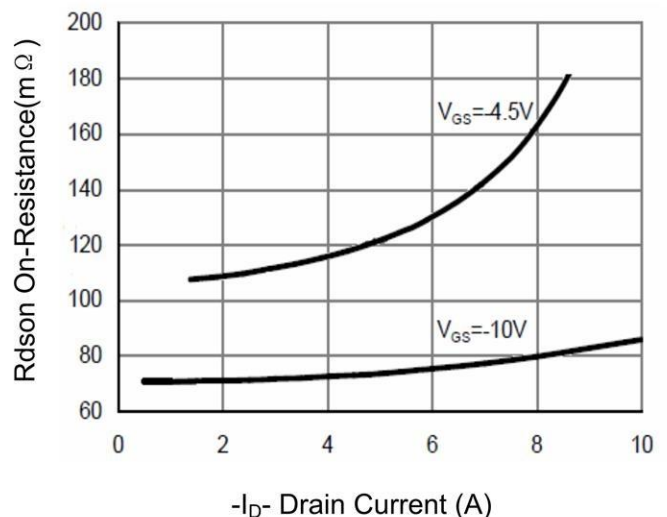

Figure 6 Drain-Source On-Resistance

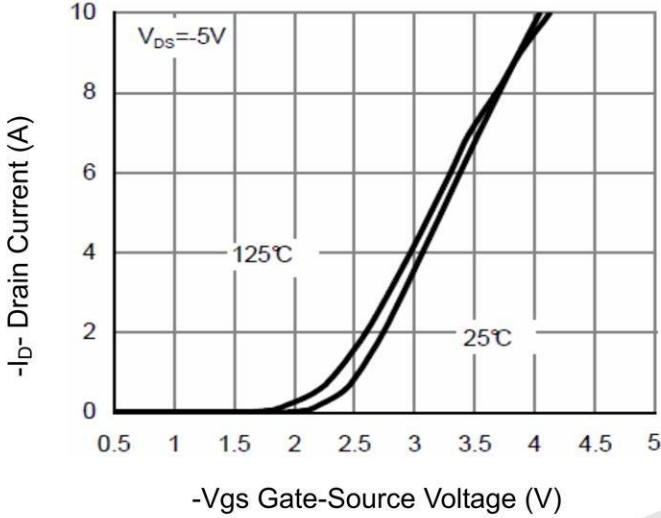

Figure 7 Transfer Characteristics

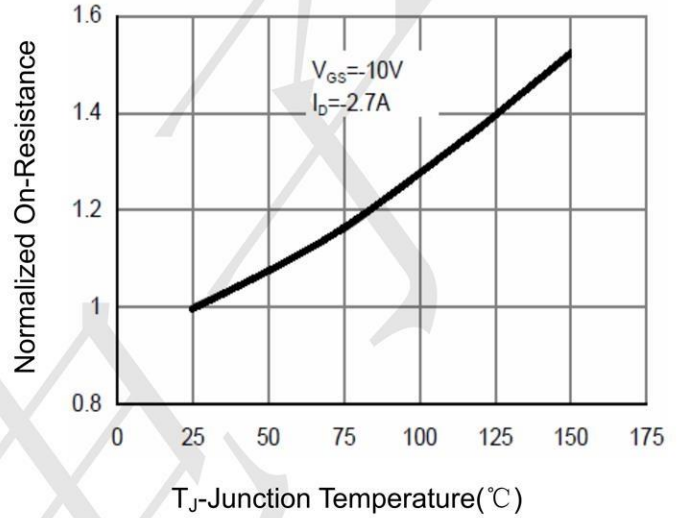

Figure 8 Drain-Source On-Resistance

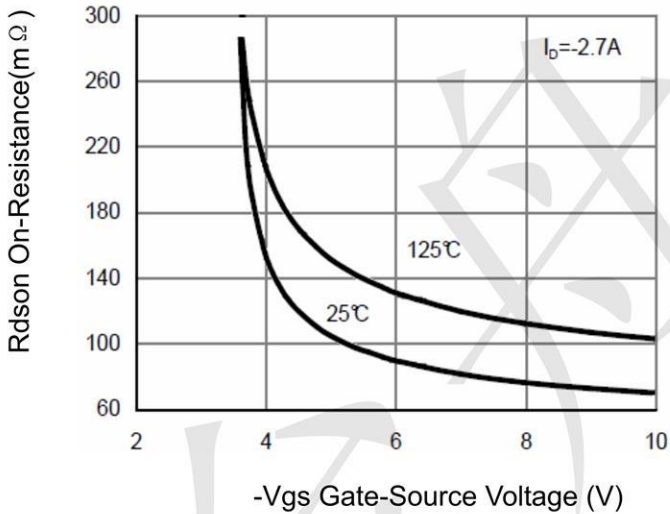

Figure 9 R_{dson} vs V_{GS}

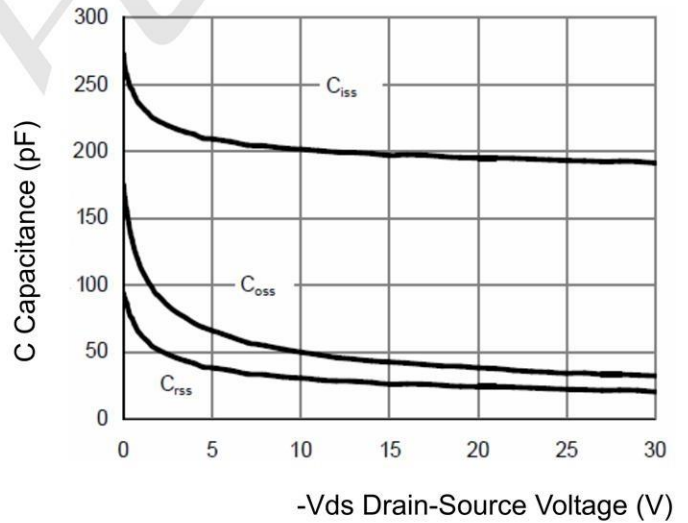

Figure 10 Capacitance vs V_{DS}

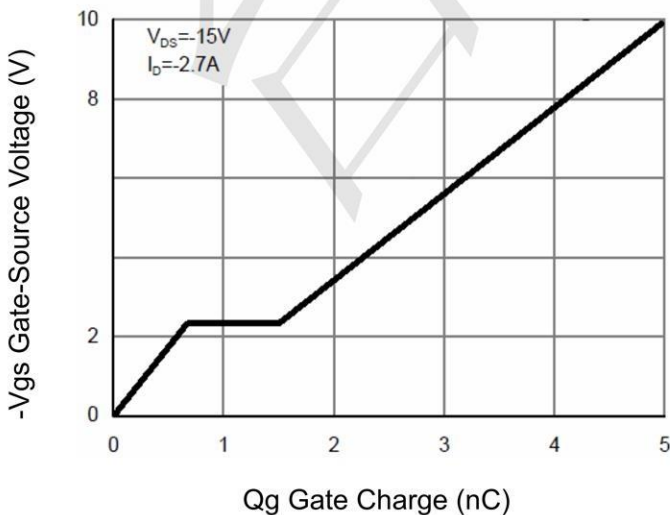

Figure 11 Gate Charge

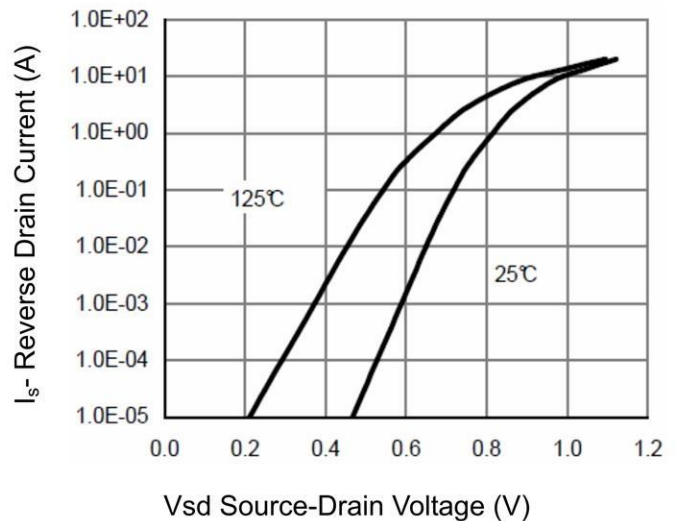

Figure 12 Source- Drain Diode Forward

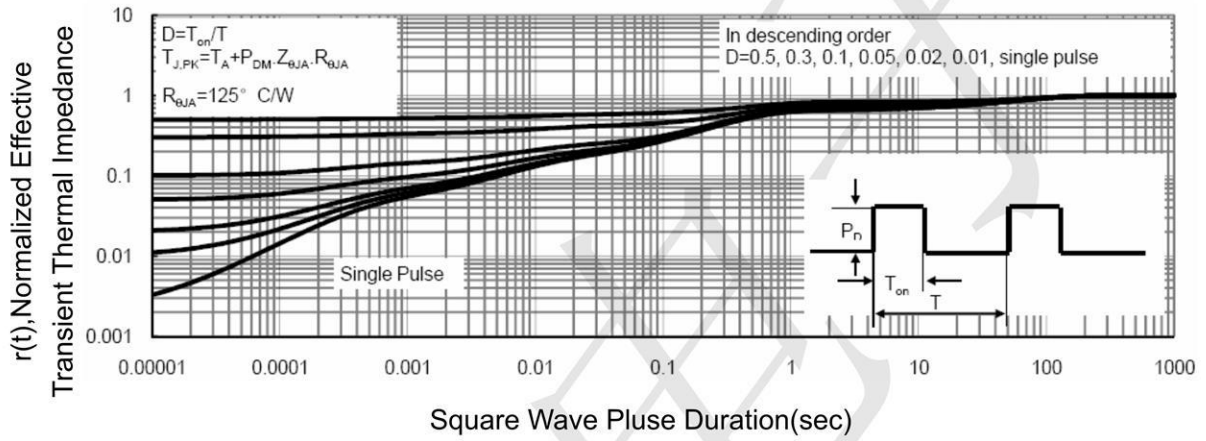
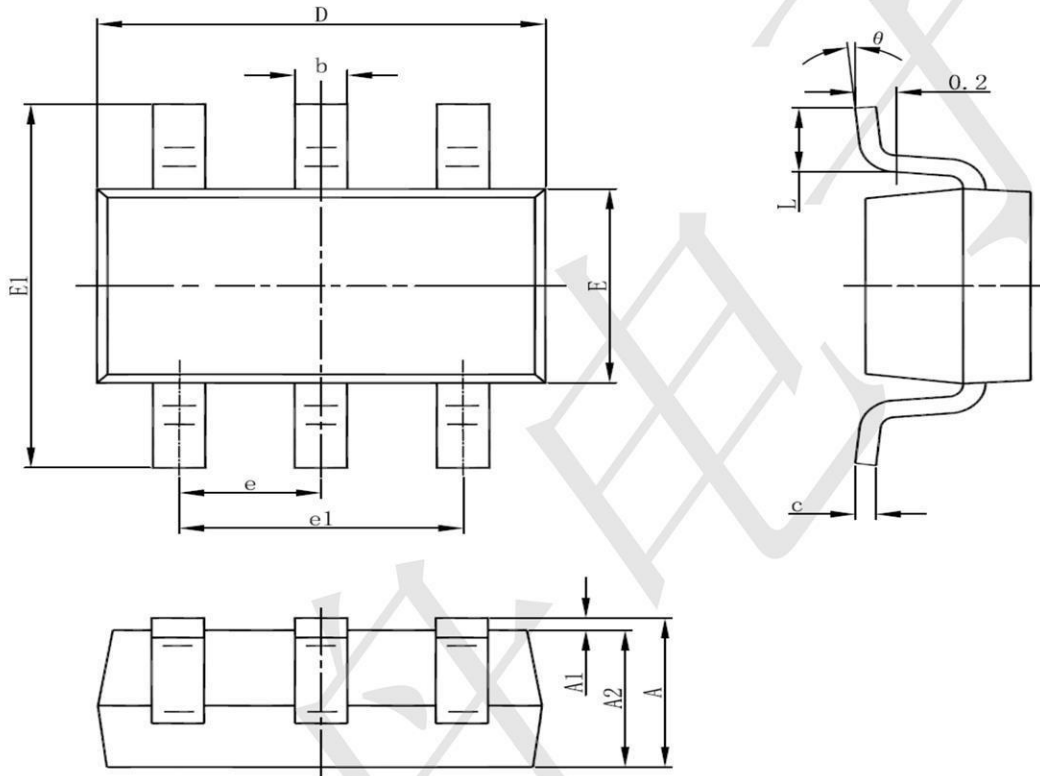

Figure 13 Normalized Maximum Transient Thermal Impedance



SOT23-6 Package Information



Symbol	Dimensions In Millimeters		Dimensions In Inches	
	Min	Max	Min	Max
A	1.050	1.250	0.041	0.049
A1	0.000	0.100	0.000	0.004
A2	1.050	1.150	0.041	0.045
b	0.300	0.500	0.012	0.020
c	0.100	0.200	0.004	0.008
D	2.820	3.020	0.111	0.119
E	1.500	1.700	0.059	0.067
E1	2.650	2.950	0.104	0.116
e	0.950(BSC)		0.037(BSC)	
e1	1.800	2.000	0.071	0.079
L	0.300	0.600	0.012	0.024
θ	0°	8°	0°	8°