

250 mA ultra low noise LDO

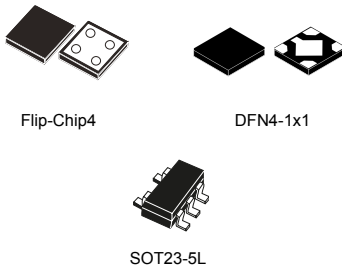

Features

- Ultra low output noise: 6.5 μV_{RMS}
- Operating input voltage range: 1.5 V to 5.5 V
- Output current up to 250 mA
- Very low quiescent current: 12 μA at no-load
- Controlled I_q in dropout condition
- Very low-dropout voltage: 250 mV at 250 mA
- Very high PSRR: 80 dB@100 Hz, 60 dB @ 100 kHz
- Output voltage accuracy: 2% across line, load and temperature
- Output voltage versions: from 1 V to 5 V, with 50 mV step
- Logic-controlled electronic shutdown
- Output discharge feature
- Internal soft-start
- Overcurrent and thermal protections
- Temperature range: from -40 °C to +125 °C
- Packages: Flip-Chip4, DFN4-1x1, SOT23-5L

Applications

- Smartphones/tablets
- Image sensors
- Instrumentation
- VCO and RF modules

Maturity status link

[LDLN025](#)

Description

The **LDLN025** is a 250 mA low-dropout voltage regulator, able to work with an input voltage range from 1.5 V to 5.5 V.

The typical dropout voltage at 250 mA load is 120 mV.

The very low quiescent current, which is just 12 μA at no-load, extends battery-life of applications requiring very long standby time.

Thanks to its ultra low noise value and high PSRR, the **LDLN025** provides a very clean output, suitable for ultra-sensitive loads. It is stable with ceramic capacitors.

The enable logic control function puts the device into shutdown mode allowing a total current consumption lower than 1 μA .

The device also includes short-circuit and thermal protection.

Typical applications are noise sensitive loads such as ADC, VCO in mobile phones and tablets, wireless LAN devices. The **LDLN025** is designed to keep the quiescent current under control and at a low value also during dropout operation, extending the operating time of battery-powered devices.

Several small package options are available.

1 Block diagram

Figure 1. Block diagram

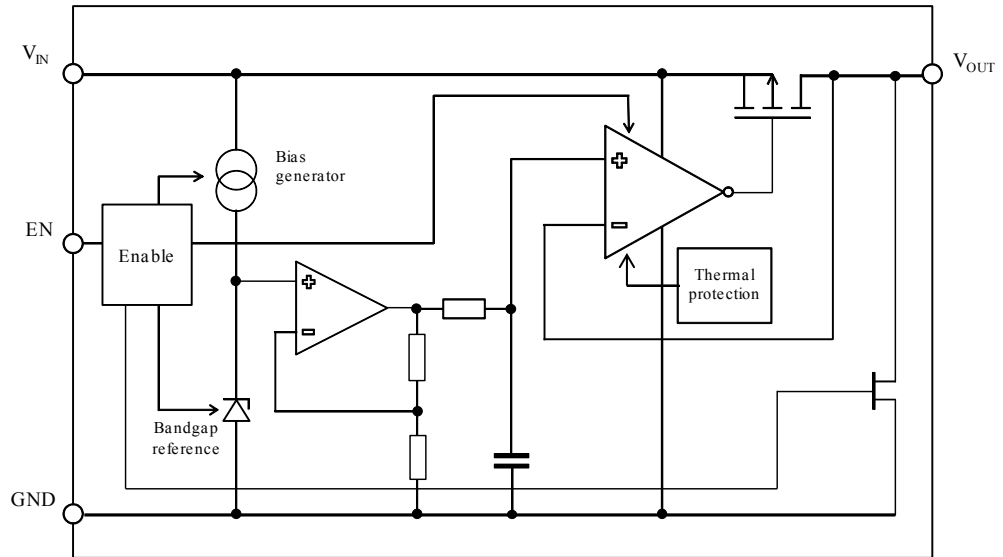

AMG280620171000MT

2 Pin configuration

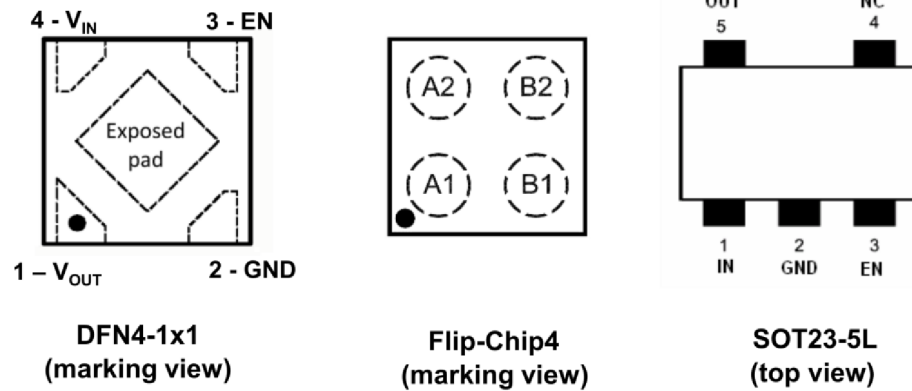
Figure 2. Pin configuration

Table 1. Pin description

| Symbol | DFN4-1x1 | Flip-Chip4 | SOT23-5L | Description |
|-------------|-------------|------------|----------|---|
| V_{IN} | 4 | A1 | 1 | LDO Supply voltage |
| V_{OUT} | 1 | A2 | 5 | LDO Output voltage |
| GND | 2 | B2 | 2 | Ground |
| EN | 3 | B1 | 3 | Enable input: set V_{EN} = high to turn on the device; V_{EN} = low to turn off the device This pin is internally pulled down via 1 M Ω resistor |
| NC | - | - | 4 | Not internally connected: can be connected to GND |
| Exposed pad | Exposed pad | - | - | Must be connected to GND |

3 Typical application diagram

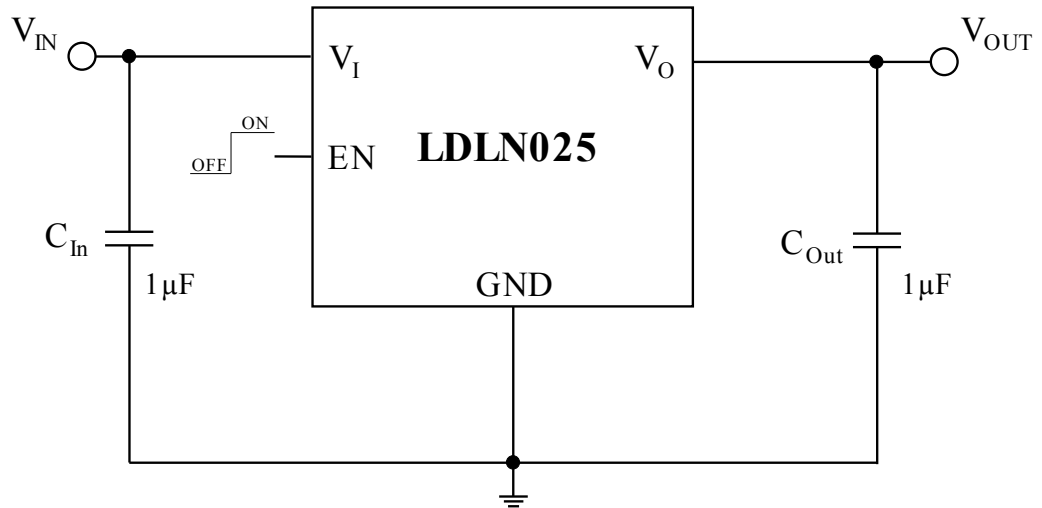
Figure 3. Typical application diagram



AMG010720161412MT

4 Maximum ratings

Table 2. Absolute maximum ratings

| Symbol | Parameter | Value | Unit |
|-------------|--------------------------------|------------------------|-------------|
| V_{IN} | Input supply voltage | -0.3 to 7 | V |
| V_{OUT} | Output voltage | -0.3 to $V_{IN} + 0.3$ | V |
| I_{OUT} | Output current | Internally limited | A |
| EN | Enable pin voltage | -0.3 to $V_{IN} + 0.3$ | V |
| P_D | Power dissipation | Internally limited | W |
| ESD | Charge device model | ± 1000 | V |
| | Human body model | ± 2000 | |
| T_{J-OP} | Operating junction temperature | -40 to 125 | $^{\circ}C$ |
| T_{J-MAX} | Maximum junction temperature | 150 | $^{\circ}C$ |
| T_{STG} | Storage temperature | -55 to 150 | $^{\circ}C$ |

Table 3. Thermal data

| Symbol | Parameter | DFN4-1x1 | Flip-Chip4 | SOT23-5L | Unit |
|------------|---|----------|------------|----------|---------------|
| R_{thja} | Thermal resistance, junction-to-ambient | 220 | 210 | 200 | $^{\circ}C/W$ |

5 Electrical characteristics

($T_J = 25\text{ °C}$, $V_{IN} = V_{OUT(nom)} + 1\text{ V}$ or 1.5 V , whichever is greater; $V_{EN} = 1.2\text{ V}$; $C_{IN} = 1\text{ }\mu\text{F}$; $C_{OUT} = 1\text{ }\mu\text{F}$; $I_{OUT} = 1\text{ mA}$)

Table 4. Electrical characteristics

| Symbol | Parameter | Test conditions | Min. | Typ. | Max. | Unit |
|---|--|---|--|-------|-------|---------------------|
| V_{IN} | Operating input voltage range | | 1.5 | | 5.5 | V |
| V_{OUT} | Output voltage accuracy (Flip-Chip package) | $V_{OUT} + 1\text{ V} < V_{IN} < 5.5\text{ V}$, ⁽¹⁾ $1\text{ mA} < I_{OUT} < 0.25\text{ A}$, $V_{OUT} \geq 1.8\text{ V}$, $-40\text{ °C} < T_J < 125\text{ °C}$ | -2.0 | | +2.0 | % |
| | | $V_{OUT} + 1\text{ V} < V_{IN} < 5.5\text{ V}$, ⁽¹⁾ $1\text{ mA} < I_{OUT} < 0.25\text{ A}$, $V_{OUT} < 1.8\text{ V}$, $-40\text{ °C} < T_J < 125\text{ °C}$ | -3.0 | | +3.0 | |
| V_{OUT} | Output voltage accuracy (DFN and SOT23 packages) | $V_{OUT} + 1\text{ V} < V_{IN} < 5.5\text{ V}$, ⁽¹⁾ $1\text{ mA} < I_{OUT} < 0.25\text{ A}$, $V_{OUT} \geq 1.8\text{ V}$, $-40\text{ °C} < T_J < 125\text{ °C}$ | -2.0 | | +2.0 | % |
| | | $V_{OUT} + 1\text{ V} < V_{IN} < 5.5\text{ V}$, ⁽¹⁾ $1\text{ mA} < I_{OUT} < 0.25\text{ A}$, $V_{OUT} < 1.8\text{ V}$, $-40\text{ °C} < T_J < 125\text{ °C}$ | -4.0 | | +4.0 | |
| $\frac{\Delta V_{OUT}}{\Delta V_{IN}}$ | Static line regulation | $V_{OUT} + 1\text{ V} < V_{IN} < 5.5\text{ V}$ ⁽¹⁾ $-40\text{ °C} < T_J < 125\text{ °C}$ | | 0.02 | | % / V |
| | | Line transient ⁽²⁾ | $\Delta V_{IN} = \pm 0.6\text{ V}$, $t_{rise} = t_{fall} = 30\text{ }\mu\text{s}$ | -1 | +1 | |
| $\frac{\Delta V_{OUT}}{\Delta I_{OUT}}$ | Static load regulation | $1\text{ mA} < I_{OUT} < 0.25\text{ A}$, $V_{OUT} \geq 1.8\text{ V}$ $-40\text{ °C} < T_J < 125\text{ °C}$, $V_{OUT} \geq 1.8\text{ V}$ | | 0.002 | | % / mA |
| | | $1\text{ mA} < I_{OUT} < 0.25\text{ A}$, $V_{OUT} < 1.8\text{ V}$ | | | 0.007 | |
| | | Load transient ⁽²⁾ | $\Delta I_{OUT} = 1\text{ mA}$ to 250 mA and back, $t_{rise} = t_{fall} = 10\text{ }\mu\text{s}$ | -40 | | +40 |
| ΔV_{OUT} | Overshoot on startup ⁽²⁾ | Percentage of $V_{OUT(nom)}$ | | | 5 | % |
| V_{DROP} | Dropout voltage ⁽³⁾ | $I_{OUT} = 0.1\text{ A}$ | | 50 | | mV |
| | | $I_{OUT} = 0.25\text{ A}$ | | 120 | | |
| | | $I_{OUT} = 0.25\text{ A}$, $-40\text{ °C} < T_J < 125\text{ °C}$ (Flip-Chip ⁴) | | | 200 | |
| | | $I_{OUT} = 0.25\text{ A}$, $-40\text{ °C} < T_J < 125\text{ °C}$ (DFN4-1x1) | | | 250 | |
| eN | Output noise voltage ⁽²⁾ | $f = 10\text{ Hz}$ to 100 kHz ; $I_{OUT} = 1\text{ mA}$ | | 10 | | μV_{RMS} |
| | | $f = 10\text{ Hz}$ to 100 kHz ; $I_{OUT} = 250\text{ mA}$ | | 6.5 | | |
| SVR | Supply voltage rejection ⁽²⁾ | $f = 100\text{ Hz}$; $I_{OUT} = 20\text{ mA}$ | | 80 | | dB |
| | | $f = 1\text{ kHz}$; $I_{OUT} = 20\text{ mA}$ | | 80 | | |
| | | $f = 10\text{ kHz}$; $I_{OUT} = 20\text{ mA}$ | | 75 | | |

| Symbol | Parameter | Test conditions | Min. | Typ. | Max. | Unit |
|------------|---|---|------|-------|------|------------------|
| SVR | Supply voltage rejection ⁽²⁾ | $f = 100 \text{ kHz}; I_{OUT} = 20 \text{ mA}$ | | 60 | | dB |
| I_Q | Quiescent current ⁽⁴⁾ | $I_{OUT} = 0 \text{ A}$ | | 12 | | μA |
| | | $I_{OUT} = 0 \text{ A}; -40 \text{ }^\circ\text{C} < T_J < 125 \text{ }^\circ\text{C}$ | | | 25 | |
| | | $I_{OUT} = 0.25 \text{ A}$ | | 250 | | μA |
| | $I_{OUT} = 0.25 \text{ A}; -40 \text{ }^\circ\text{C} < T_J < 125 \text{ }^\circ\text{C}$ | | | 425 | | |
| | Shutdown current | $V_{EN} = 0 \text{ V}$ | | 0.2 | 1 | μA |
| I_{SC} | Short-circuit current | $V_{OUT} = 0 \text{ V}$ | 250 | 500 | | mA |
| R_{LOW} | Output discharge resistance | $V_{EN} = 0 \text{ V}$ | | 230 | | Ω |
| V_{EN} | V_{IL} , enable input logic low | $V_{OUT} + 1 \text{ V} < V_{IN} < 5.5 \text{ V}; -40 \text{ }^\circ\text{C} < T_J < 125 \text{ }^\circ\text{C}^{(1)}$ | | | 0.4 | V |
| | V_{IH} , enable input logic high | | 1.2 | | | |
| I_{EN} | Enable pin input current | $V_{IN} = V_{EN} = 5.5 \text{ V}$ | | 5.5 | | μA |
| | | $V_{IN} = 5.5 \text{ V}; V_{EN} = 0 \text{ V}$ | | 0.001 | | |
| t_{ON} | Turn-on time ⁽²⁾ | From $V_{EN} > V_{IH}$ to $V_{OUT} = 95 \%$ of $V_{OUT(nom)}$ | | 80 | 150 | μs |
| T_{SHDN} | Thermal shutdown ⁽²⁾ | $I_{OUT} > 1 \text{ mA}$ | | 160 | | $^\circ\text{C}$ |
| | Hysteresis | | | 20 | | |

- $V_{IN} = V_{OUT} + 1 \text{ V}$ or 1.5 V , whichever is greater. Not applicable for 5 V output voltage versions.
- Guaranteed by design.
- Dropout voltage is the input-to-output voltage difference at which the output voltage is 100 mV below its nominal value.
- The quiescent current is defined as $I_{IN} - I_{OUT}$ and does not include the EN pin current.

Table 5. Recommended input and output capacitors

| Symbol | Parameter | Test conditions | Min. | Typ. | Max. | Unit |
|-----------|--------------------------|-----------------|------|------|------|---------------|
| C_{IN} | Input capacitance | Stability | 0.7 | 1 | | μF |
| C_{OUT} | Output capacitance | | 0.7 | 1 | 10 | |
| ESR | Output/input capacitance | | 5 | | 500 | m Ω |

6 Typical characteristics

(The following plots are referred to LDLN025J2925R in the typical application circuit and, unless otherwise noted, at $T_A = 25\text{ }^\circ\text{C}$).

Figure 4. Output voltage vs. temperature ($V_{IN} = 3.925\text{ V}$)

$V_{IN} = V_{OUT} + 1\text{ V}$, $EN = 2\text{ V}$, $I_{OUT} = \text{from } 0\text{ to } 250\text{ mA}$, $C_{IN} = 1\text{ }\mu\text{F}$, $C_{OUT} = 1\text{ }\mu\text{F}$

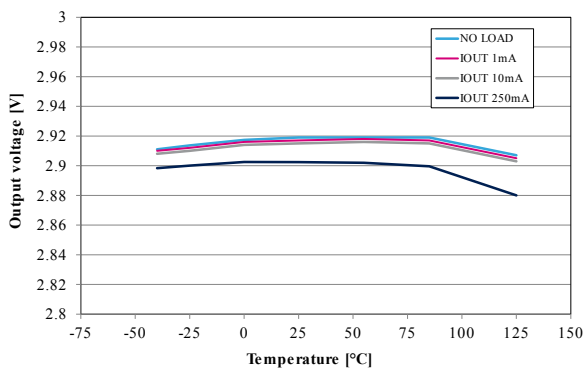

AMG010720161030MT

Figure 5. Output voltage vs. temperature ($V_{IN} = 5.5\text{ V}$)

$V_{IN} = 5.5\text{ V}$; $I_{OUT} = \text{from } 0\text{ to } 250\text{ mA}$, $C_{IN} = 1\text{ }\mu\text{F}$, $C_{OUT} = 1\text{ }\mu\text{F}$

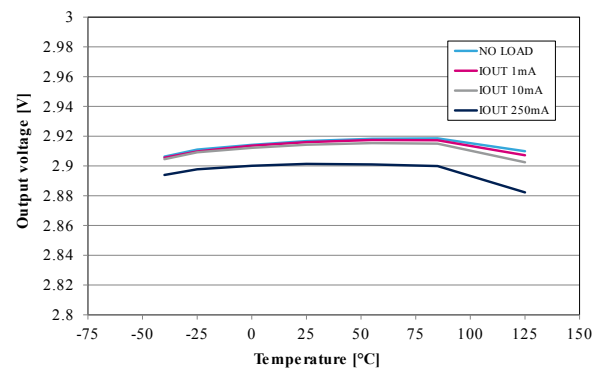

AMG010720161031MT

Figure 6. Load regulation vs. temperature

$V_{IN} = V_{OUT} + 1\text{ V}$; $I_{OUT} = \text{from } 1\text{ mA to } 0.25\text{ A}$, $C_{IN} = 1\text{ }\mu\text{F}$, $C_{OUT} = 1\text{ }\mu\text{F}$

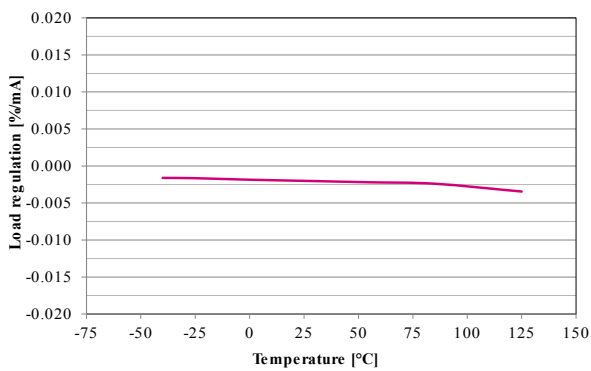

AMG010720161032MT

Figure 7. Line regulation vs. temperature

$V_{IN} = \text{from } 3.925\text{ to } 5.5\text{ V}$, $I_{OUT} = 1\text{ mA}$, $C_{IN} = 1\text{ }\mu\text{F}$, $C_{OUT} = 1\text{ }\mu\text{F}$

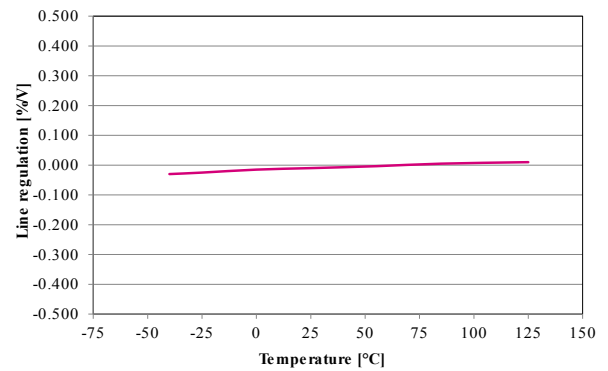

AMG010720161033MT

Figure 8. Quiescent current vs. temperature ($I_{OUT} = 0$ mA)

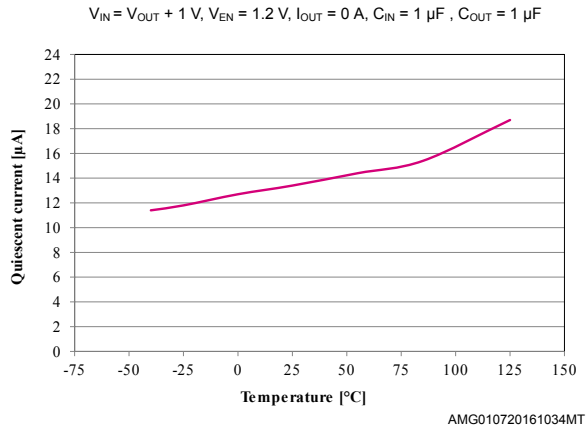

Figure 9. Quiescent current vs. temperature ($I_{OUT} = 250$ mA)

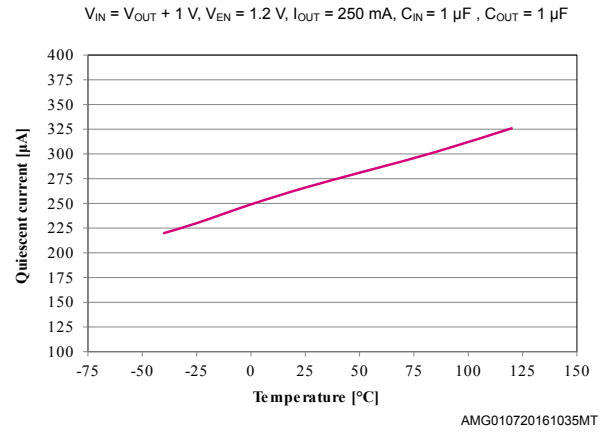

Figure 10. GND current vs. input voltage

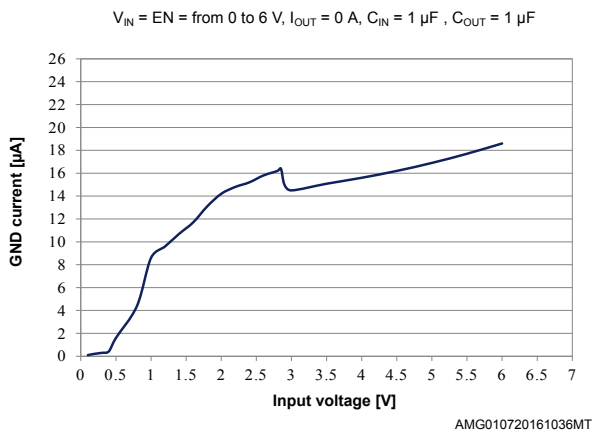

Figure 11. Off-state current vs. temperature

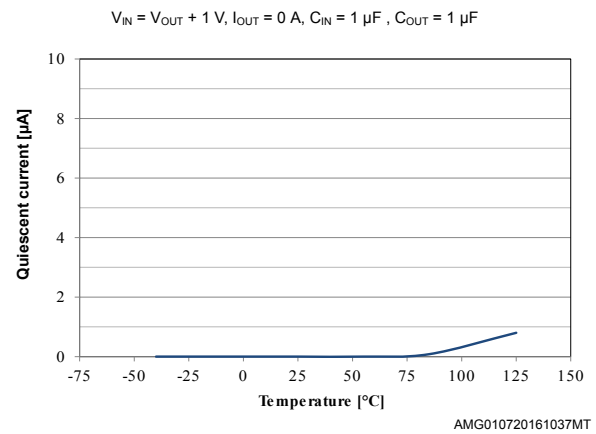

Figure 12. Quiescent current vs. output current

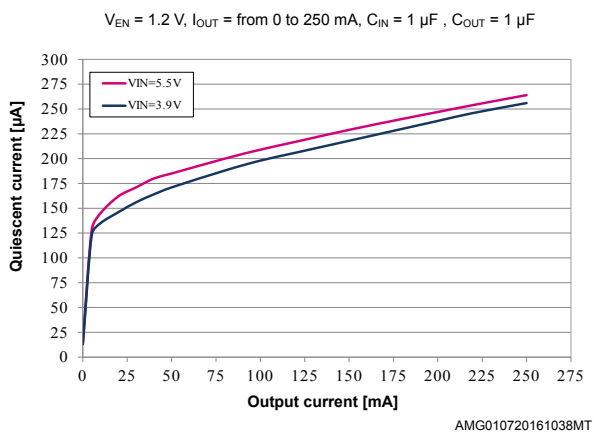

Figure 13. Quiescent current vs. output current (zoom)

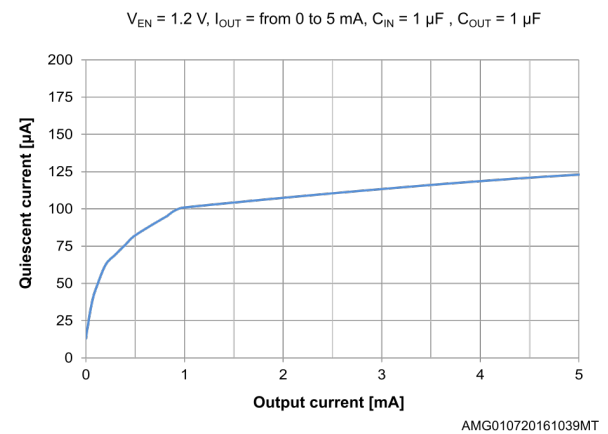

Figure 14. Dropout voltage vs. temperature

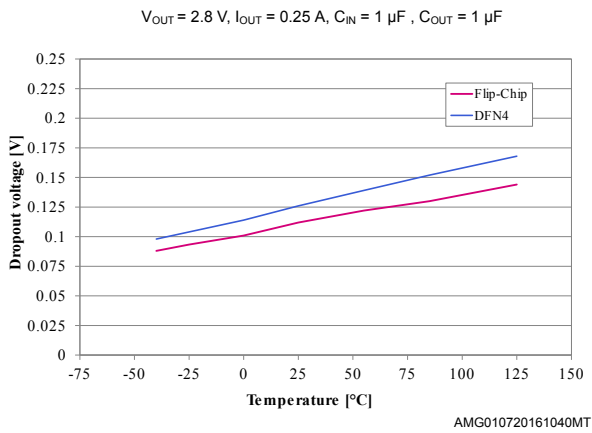

Figure 15. Dropout voltage vs. load current

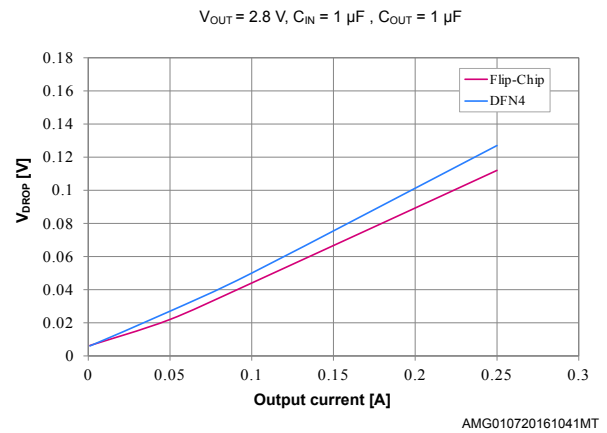

Figure 16. Output voltage vs. input voltage

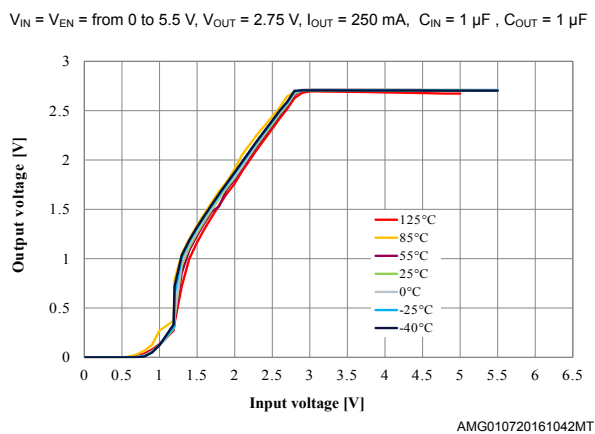

Figure 17. Short circuit current vs. dropout voltage

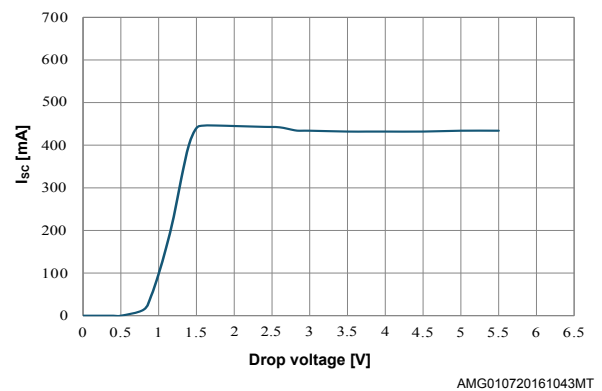

Figure 18. Enable threshold vs. temperature

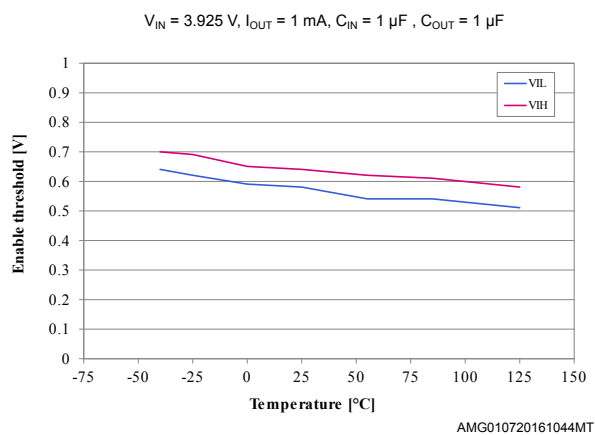

Figure 19. Stability region vs. C_{OUT} and ESR

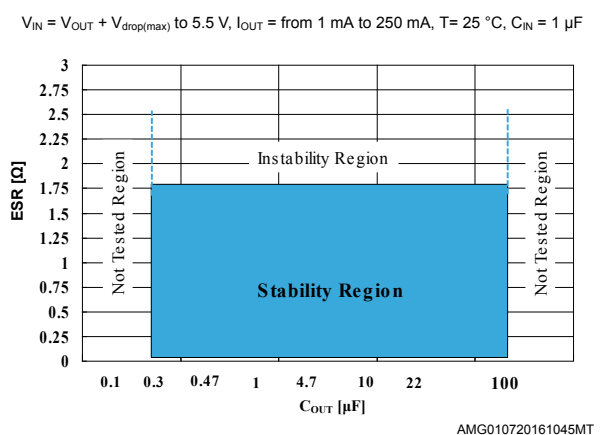

Figure 20. PSRR vs. frequency ($V_{OUT} = 2.75\text{ V}$)

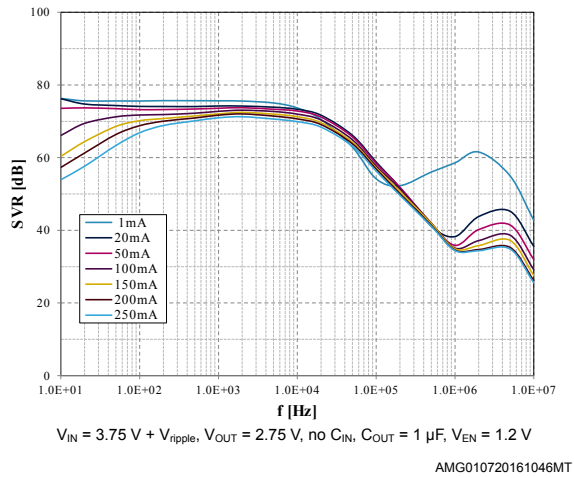

Figure 21. PSRR vs. frequency ($V_{OUT} = 1.8\text{ V}$)

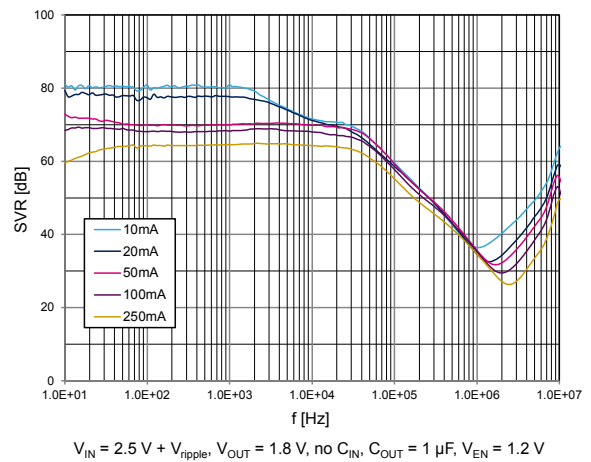

Figure 22. PSRR vs. frequency ($V_{OUT} = 5\text{ V}$)

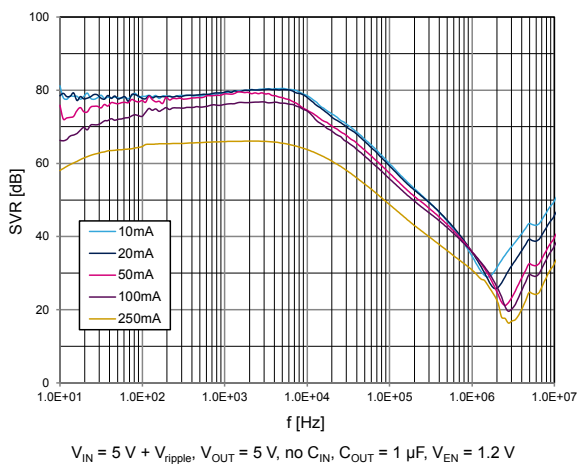

Figure 23. Noise density

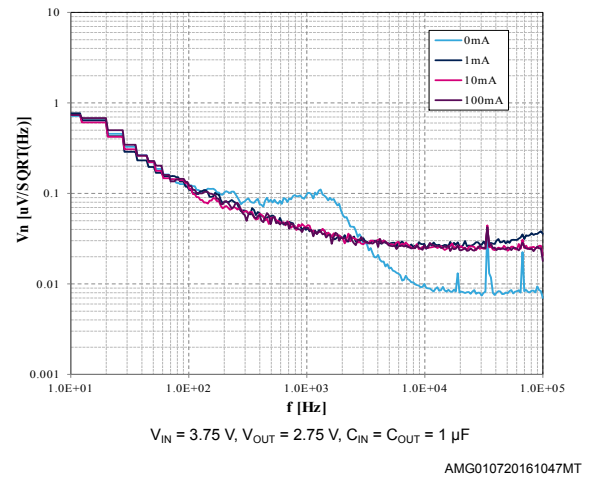

Figure 24. Line transient ($I_{OUT} = 1\text{ mA}$)

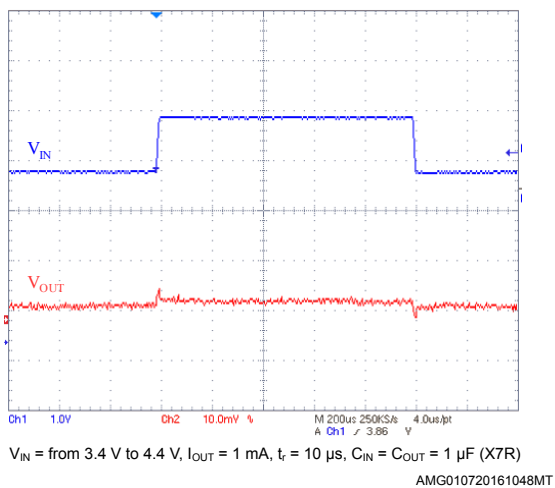

Figure 25. Line transient ($I_{OUT} = 250\text{ mA}$)

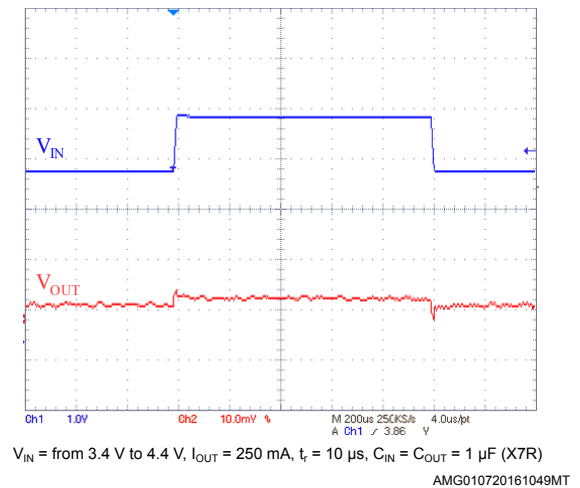
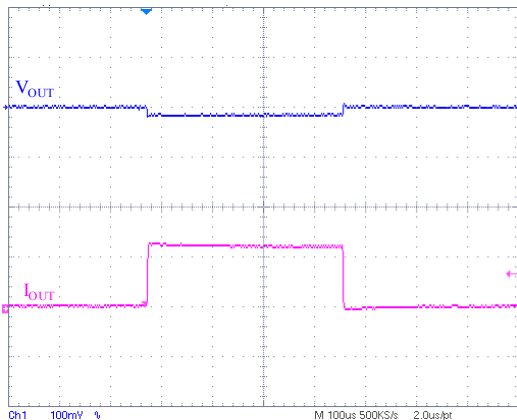

Figure 26. Load transient



I_{OUT} = from 0 mA to 250 mA, t_t = 10 μ s, C_{IN} = C_{OUT} = 1 μ F (X7R)

AMG010720161050MT

Figure 27. Inrush current

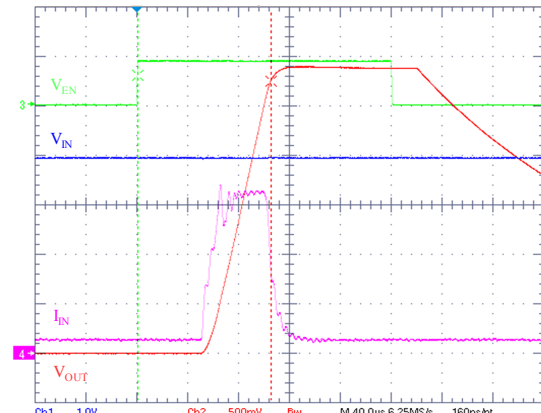

V_{IN} = 4 V, I_{OUT} = 0 mA, C_{IN} = C_{OUT} = 1 μ F (X7R)

AMG180720161000MT

Figure 28. Enable transient (I_{OUT} = 0 mA)

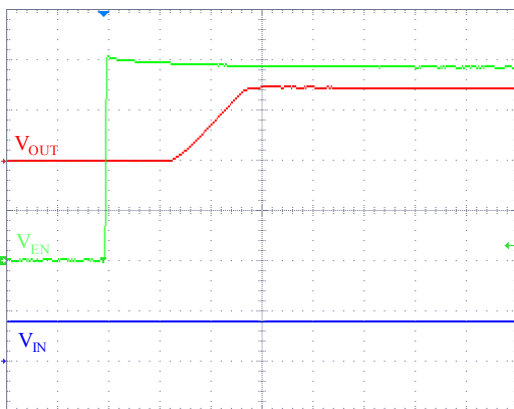

V_{IN} = 3.925 V, V_{EN} = from 0 V to 3.925 V, I_{OUT} = 0 mA, t_t = 1 μ s, C_{IN} = C_{OUT} = 1 μ F (X7R)

AMG010720161052MT

Figure 29. Enable transient (I_{OUT} = 250 mA)

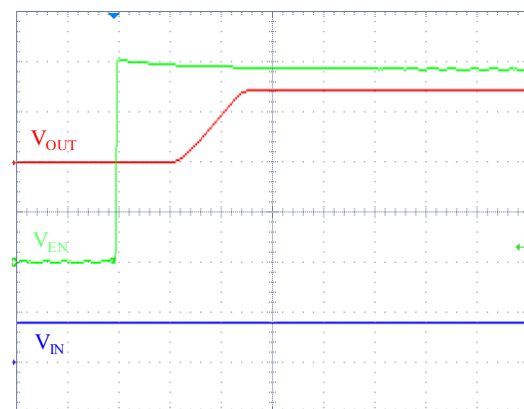

V_{IN} = 3.925 V, V_{EN} = from 0 V to 3.925 V, I_O = 250 mA, t_t = 1 μ s, C_{IN} = C_{OUT} = 1 μ F (X7R)

AMG010720161053MT

7 Package information

In order to meet environmental requirements, ST offers these devices in different grades of **ECOPACK** packages, depending on their level of environmental compliance. ECOPACK specifications, grade definitions and product status are available at: www.st.com. ECOPACK is an ST trademark.

7.1 Flip-Chip4 package information

Figure 30. Flip-Chip4 package outline

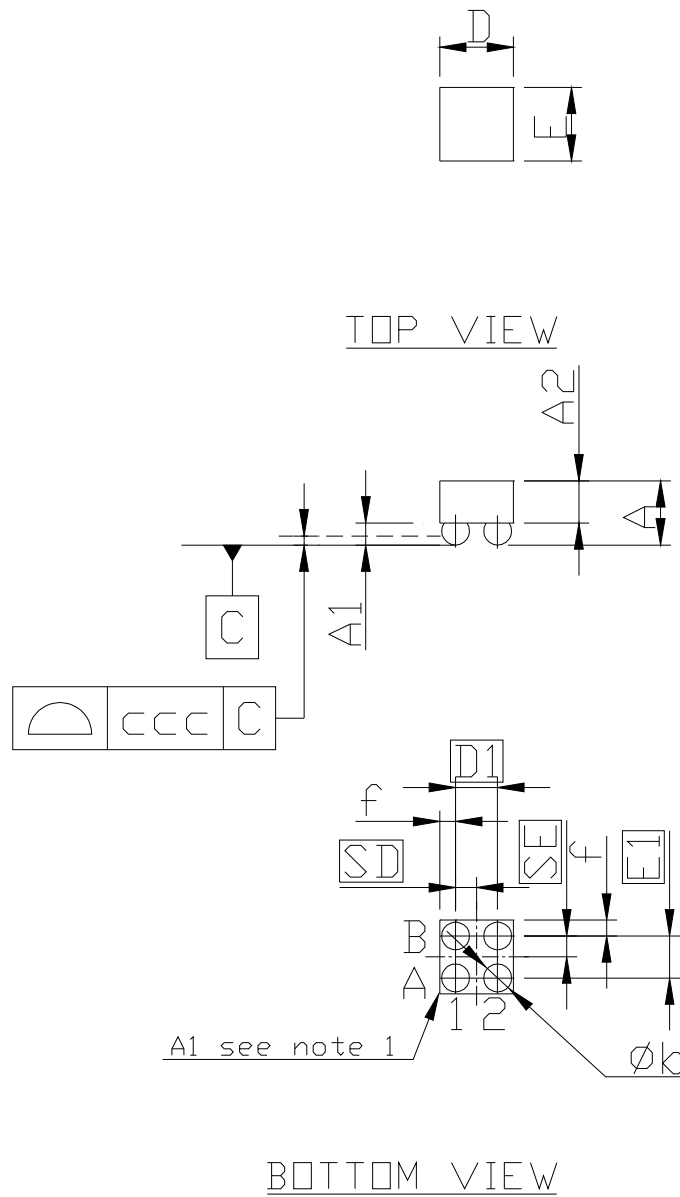

8387748 option F

Table 6. Flip-Chip4 mechanical data

| Dim. | mm | | |
|-------------------|-------|-------|-------|
| | Min. | Typ. | Max. |
| A | 0.375 | 0.410 | 0.445 |
| A1 | 0.145 | 0.160 | 0.175 |
| A2 ⁽¹⁾ | 0.230 | 0.250 | 0.270 |
| b | 0.189 | 0.210 | 0.231 |
| D | 0.598 | 0.628 | 0.658 |
| D1 | | 0.350 | |
| E | 0.598 | 0.628 | 0.658 |
| E1 | | 0.350 | |
| SD | | 0.175 | |
| SE | | 0.175 | |
| f | | 0.139 | |
| ccc | | 0.075 | |

1. Including back coating.

Figure 31. Flip-Chip4 recommended footprint

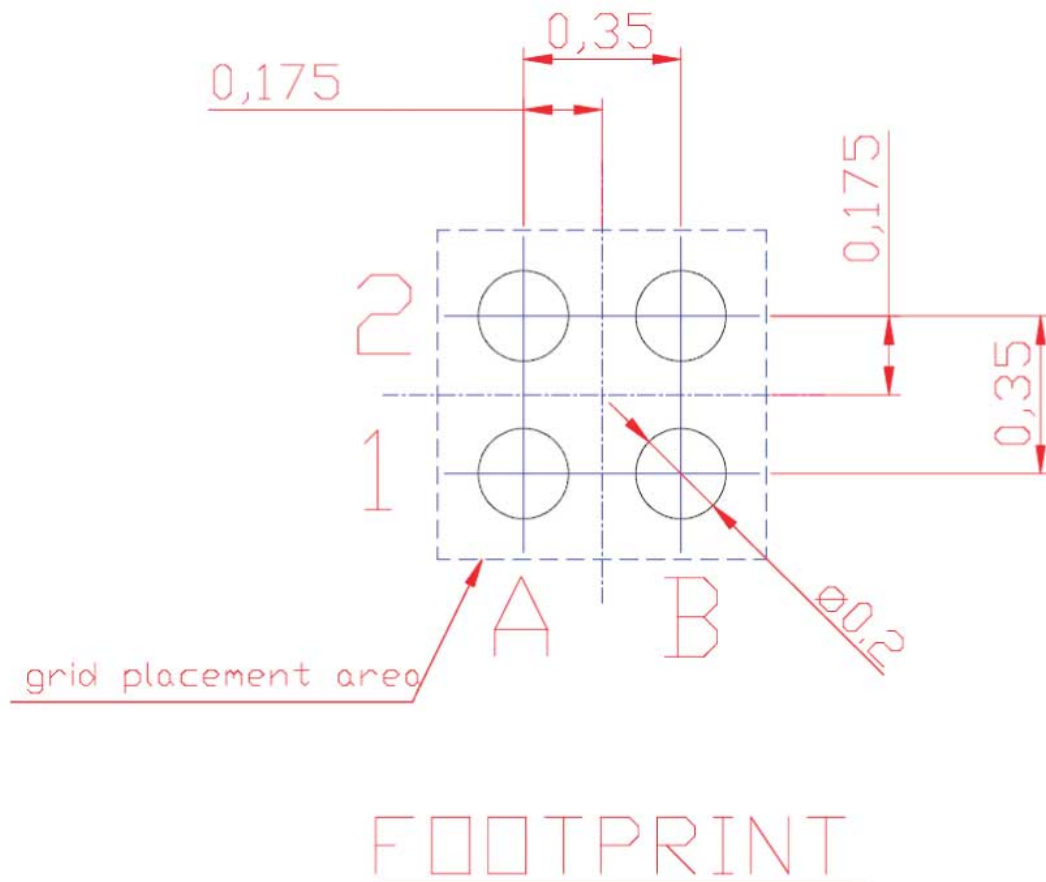

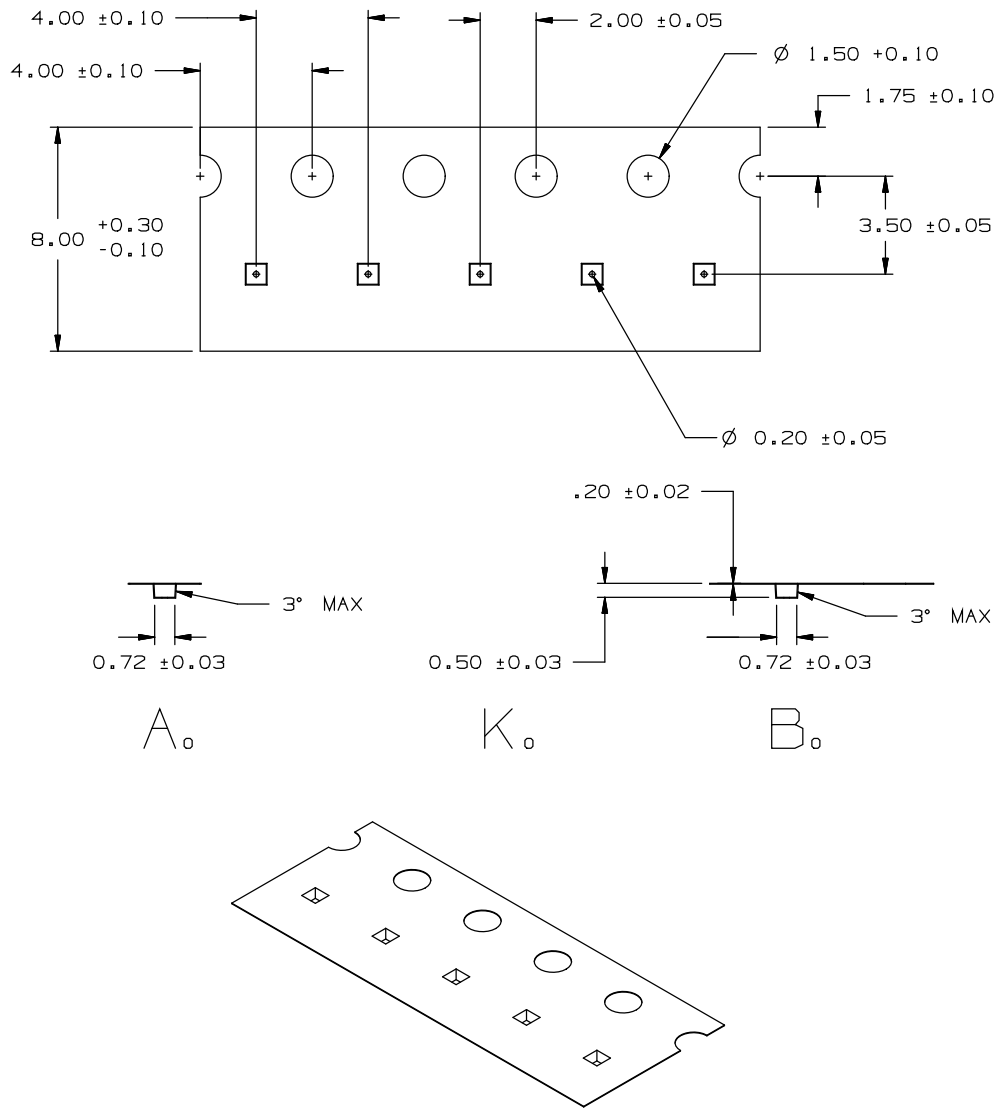
7.2 Flip-Chip4_160304-47_carrier_tape
Figure 32. Flip-Chip4 carrier tape

7.3 DFN4-1x1 package info

Figure 33. DFN4-1x1 package outline

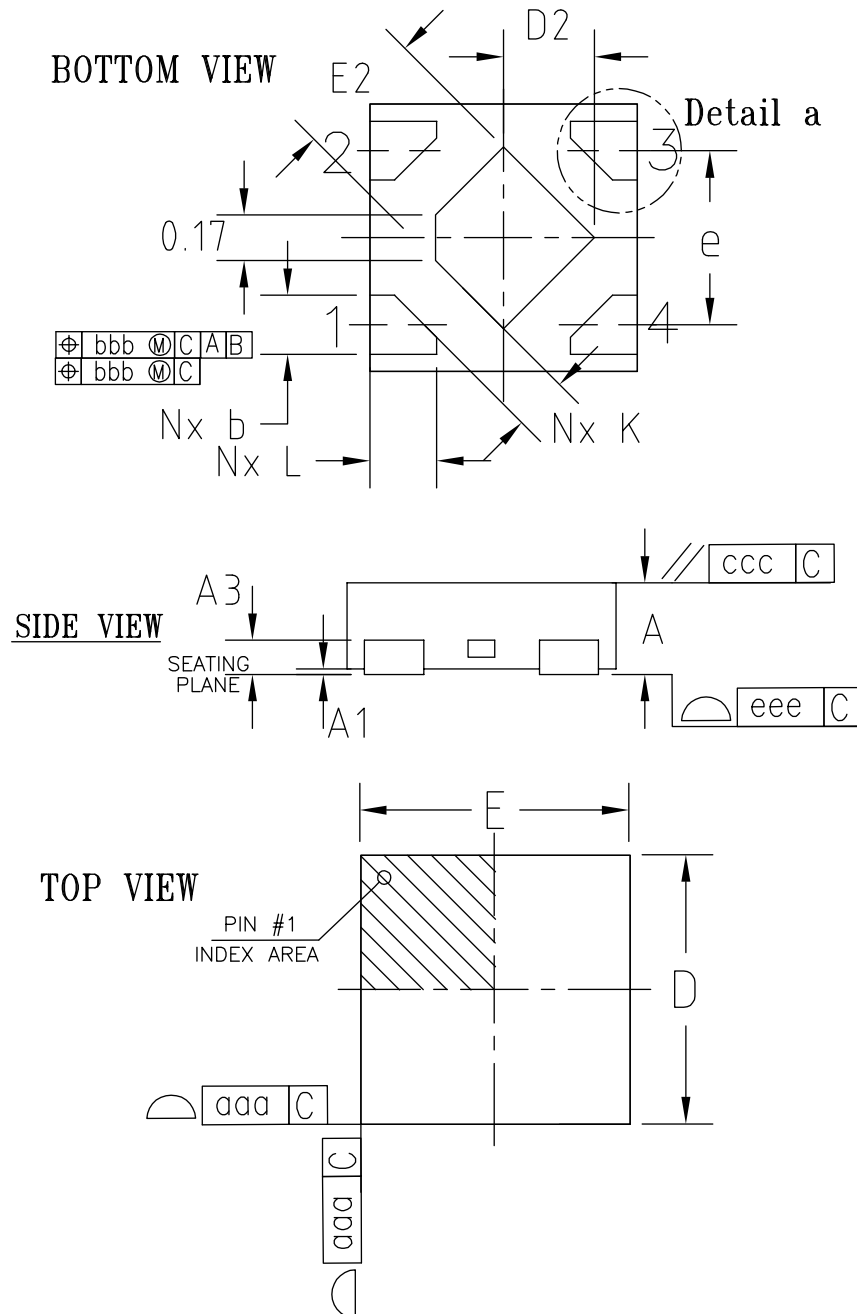

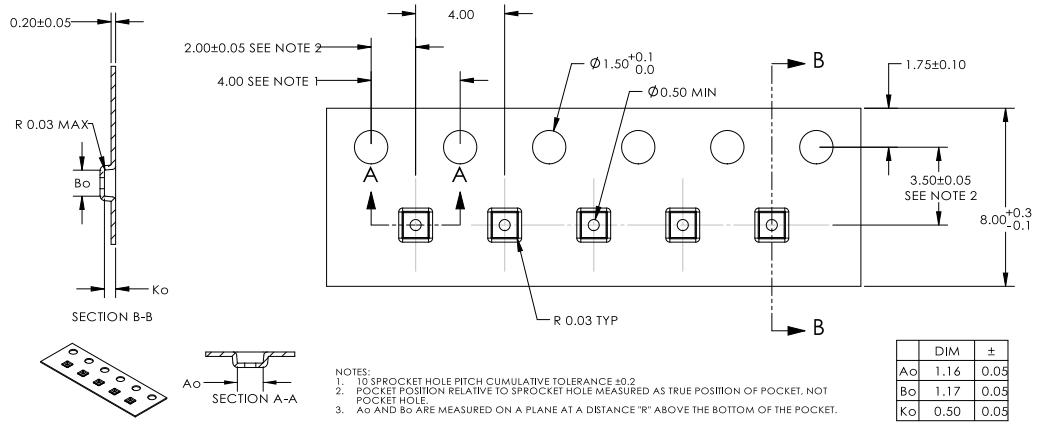
7.4 DFN4_1x1x0.38_pitch_4mm_carrier_tape
Figure 35. DFN4 (1x1x0.38 pitch 4 mm) carrier tape

7.5 SOT23-5L mechanical data

Figure 36. SOT23-5L package outline

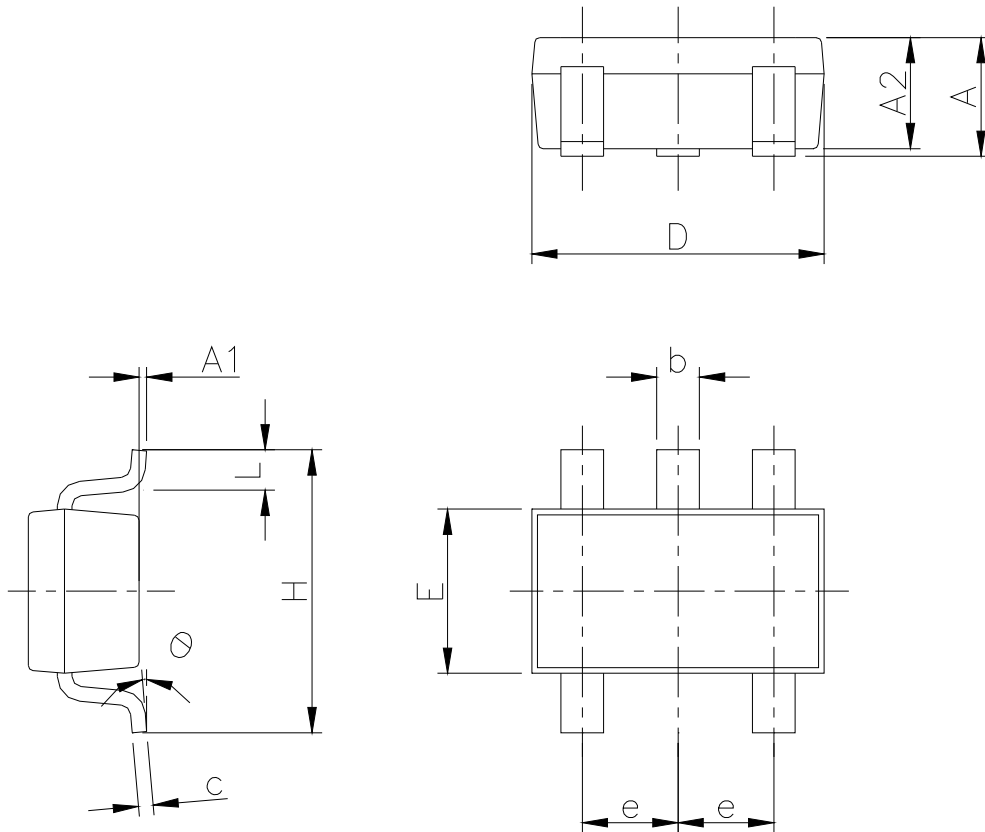

7049676_k

Table 8. SOT23-5L package mechanical data

| Dim. | mm | | |
|----------|------|------|------|
| | Min. | Typ. | Max. |
| A | 0.90 | | 1.45 |
| A1 | 0 | | 0.15 |
| A2 | 0.90 | | 1.30 |
| b | 0.30 | | 0.50 |
| c | 0.09 | | 0.20 |
| D | | 2.95 | |
| E | | 1.60 | |
| e | | 0.95 | |
| H | | 2.80 | |
| L | 0.30 | | 0.60 |
| θ | 0° | | 8° |

Figure 37. SOT23-5L recommended footprint

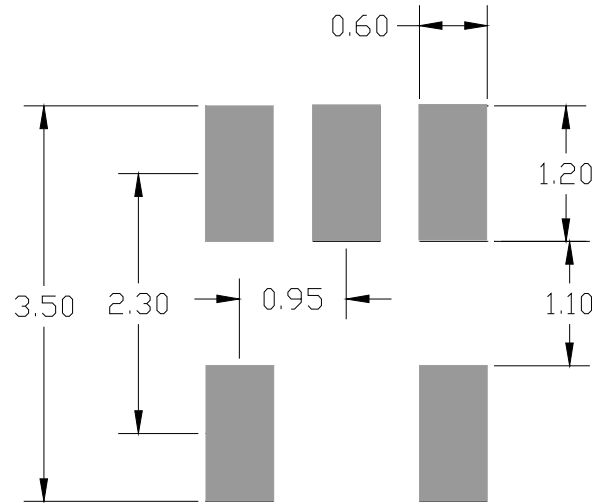

Note: Dimensions are in mm

8 Ordering information

Table 9. Order code

| Order code | Package | Output voltage (V) | Marking | Packing |
|----------------------------|----------|--------------------|---------|---------------|
| LDLN025PU12R | DFN4-1x1 | 1.2 | 12 | Tape and reel |
| LDLN025PU18R | | 1.8 | 18 | |
| LDLN025PU25R | | 2.5 | 25 | |
| LDLN025PU275R | | 2.75 | 2Z | |
| LDLN025PU28R | | 2.8 | 28 | |
| LDLN025PU29R | | 2.9 | 29 | |
| LDLN025PU30R | | 3.0 | 30 | |
| LDLN025PU32R | | 3.2 | 32 | |
| LDLN025PU33R | | 3.3 | 33 | |
| LDLN025PU50R | | 5.0 | 50 | |
| LDLN025J12R | | Flip-Chip4 | 1.2 | |
| LDLN025J18R | 1.8 | | E | |
| LDLN025J25R | 2.5 | | H | |
| LDLN025J28R | 2.8 | | I | |
| LDLN025J29R | 2.9 | | S | |
| LDLN025J2925R | 2.925 | | K | |
| LDLN025J30R ⁽¹⁾ | 3.0 | | G | |
| LDLN025J32R | 3.2 | | N | |
| LDLN025J33R | 3.3 | | F | |
| LDLN025J50R | 5.0 | | P | |
| LDLN025M12R | SOT23-5L | 1.2 | LN12 | |
| LDLN025M15R | | 1.5 | LN15 | |
| LDLN025M18R | | 1.8 | LN18 | |
| LDLN025M25R | | 2.5 | LN25 | |
| LDLN025M28R | | 2.8 | LN28 | |
| LDLN025M30R | | 3.0 | LN30 | |
| LDLN025M33R | | 3.3 | LN33 | |
| LDLN025M45R | | 4.5 | LN45 | |

1. Part number in development. Contact our sales office.

8.1 Marking information

Figure 38. Flip-Chip marking composition (marking view)

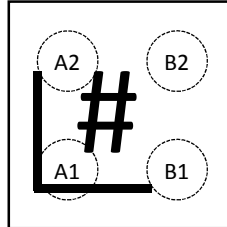

AMG260720161100MT

Note: the symbol # indicates the marking digit, as per [Table 9. Order code](#).

Revision history

Table 10. Document revision history

| Date | Revision | Changes |
|-------------|----------|---|
| 03-Aug-2016 | 1 | First release. |
| 01-Sep-2016 | 2 | Updated Table 8: "Order code". Minor text changes. |
| 24-Oct-2016 | 3 | Updated Table 2: "Absolute maximum ratings". Minor text changes. |
| 17-Nov-2016 | 4 | Updated Section 9: "Ordering information". Minor text changes. |
| 12-Jul-2017 | 5 | Added SOT23-5L package. Modified silhouette, features, Figure 1: "Block diagram", Section 2: "Pin configuration" and Table 4: "Electrical characteristics". Added Section 7.5: "SOT23-5L package information". Updated Table 9: "Order code". Minor text changes. |
| 09-Oct-2018 | 6 | Added Figure 21. PSRR vs. frequency (VOUT = 1.8 V), Figure 22. PSRR vs. frequency (VOUT = 5 V), new order codes LDLN025PU12R and LDLN025J29R in Table 9. Order code. |
| 08-May-2019 | 7 | Added footnote on A2 parameter in Table 6. Flip-Chip4 mechanical data.. |
| 16-Jul-2021 | 8 | Update Figure 33. DFN4-1x1 package outline and Table 7. DFN4-1x1 package mechanical data |

Contents

| | | |
|----------|--|-----------|
| 1 | Block diagram | 2 |
| 2 | Pin configuration | 3 |
| 3 | Typical application diagram | 4 |
| 4 | Maximum ratings | 5 |
| 5 | Electrical characteristics | 6 |
| 6 | Typical characteristics | 8 |
| 7 | Package information | 13 |
| 7.1 | Flip-Chip4 package information | 13 |
| 7.2 | Flip-Chip4 packing information | 15 |
| 7.3 | DFN4-1x1 package information | 16 |
| 7.4 | DFN4-1x1 packing information | 18 |
| 7.5 | SOT23-5L package information | 19 |
| 8 | Ordering information | 21 |
| 8.1 | Marking information | 22 |
| | Revision history | 23 |
| | Contents | 24 |
| | List of tables | 25 |
| | List of figures | 26 |

List of tables

| | | |
|------------------|---|----|
| Table 1. | Pin description | 3 |
| Table 2. | Absolute maximum ratings | 5 |
| Table 3. | Thermal data | 5 |
| Table 4. | Electrical characteristics | 6 |
| Table 5. | Recommended input and output capacitors | 7 |
| Table 6. | Flip-Chip4 mechanical data | 14 |
| Table 7. | DFN4-1x1 package mechanical data | 17 |
| Table 8. | SOT23-5L package mechanical data | 19 |
| Table 9. | Order code | 21 |
| Table 10. | Document revision history | 23 |

List of figures

| | | |
|-------------------|---|----|
| Figure 1. | Block diagram | 2 |
| Figure 2. | Pin configuration | 3 |
| Figure 3. | Typical application diagram | 4 |
| Figure 4. | Output voltage vs. temperature ($V_{IN} = 3.925\text{ V}$) | 8 |
| Figure 5. | Output voltage vs. temperature ($V_{IN} = 5.5\text{ V}$) | 8 |
| Figure 6. | Load regulation vs. temperature | 8 |
| Figure 7. | Line regulation vs. temperature | 8 |
| Figure 8. | Quiescent current vs. temperature ($I_{OUT} = 0\text{ mA}$) | 9 |
| Figure 9. | Quiescent current vs. temperature ($I_{OUT} = 250\text{ mA}$) | 9 |
| Figure 10. | GND current vs. input voltage | 9 |
| Figure 11. | Off-state current vs. temperature | 9 |
| Figure 12. | Quiescent current vs. output current | 9 |
| Figure 13. | Quiescent current vs. output current (zoom) | 9 |
| Figure 14. | Dropout voltage vs. temperature | 10 |
| Figure 15. | Dropout voltage vs. load current | 10 |
| Figure 16. | Output voltage vs. input voltage | 10 |
| Figure 17. | Short circuit current vs. dropout voltage | 10 |
| Figure 18. | Enable threshold vs. temperature | 10 |
| Figure 19. | Stability region vs. C_{OUT} and ESR | 10 |
| Figure 20. | PSRR vs. frequency ($V_{OUT} = 2.75\text{ V}$) | 11 |
| Figure 21. | PSRR vs. frequency ($V_{OUT} = 1.8\text{ V}$) | 11 |
| Figure 22. | PSRR vs. frequency ($V_{OUT} = 5\text{ V}$) | 11 |
| Figure 23. | Noise density | 11 |
| Figure 24. | Line transient ($I_{OUT} = 1\text{ mA}$) | 11 |
| Figure 25. | Line transient ($I_{OUT} = 250\text{ mA}$) | 11 |
| Figure 26. | Load transient | 12 |
| Figure 27. | Inrush current | 12 |
| Figure 28. | Enable transient ($I_{OUT} = 0\text{ mA}$) | 12 |
| Figure 29. | Enable transient ($I_{OUT} = 250\text{ mA}$) | 12 |
| Figure 30. | Flip-Chip4 package outline | 13 |
| Figure 31. | Flip-Chip4 recommended footprint | 14 |
| Figure 32. | Flip-Chip4 carrier tape | 15 |
| Figure 33. | DFN4-1x1 package outline | 16 |
| Figure 34. | DFN4-1x1 recommended footprint | 17 |
| Figure 35. | DFN4 (1x1x0.38 pitch 4 mm) carrier tape | 18 |
| Figure 36. | SOT23-5L package outline | 19 |
| Figure 37. | SOT23-5L recommended footprint | 20 |
| Figure 38. | Flip-Chip marking composition (marking view) | 22 |

IMPORTANT NOTICE – PLEASE READ CAREFULLY

STMicroelectronics NV and its subsidiaries (“ST”) reserve the right to make changes, corrections, enhancements, modifications, and improvements to ST products and/or to this document at any time without notice. Purchasers should obtain the latest relevant information on ST products before placing orders. ST products are sold pursuant to ST’s terms and conditions of sale in place at the time of order acknowledgement.

Purchasers are solely responsible for the choice, selection, and use of ST products and ST assumes no liability for application assistance or the design of Purchasers’ products.

No license, express or implied, to any intellectual property right is granted by ST herein.

Resale of ST products with provisions different from the information set forth herein shall void any warranty granted by ST for such product.

ST and the ST logo are trademarks of ST. For additional information about ST trademarks, please refer to www.st.com/trademarks. All other product or service names are the property of their respective owners.

Information in this document supersedes and replaces information previously supplied in any prior versions of this document.

© 2021 STMicroelectronics – All rights reserved