

Features

- Ultra low leakage: nA level
- Operating voltage: 5V
- Low clamping voltage
- Complies with following standards:
 - IEC 61000-4-2 (ESD) immunity test
 - Air discharge: $\pm 18\text{kV}$
 - Contact discharge: $\pm 15\text{kV}$
 - IEC61000-4-4 (EFT) 40A (5/50ns)
 - IEC61000-4-5 (Lightning) 5A (8/20ns)
- RoHS Compliant

Applications

- USB 2.0/3.1 power and data line
- Set-top box and digital TV
- Digital video interface (DVI)
- Notebook Computers
- SIM Ports
- 10/100/1000 Ethernet
- HDMI 1.3/1.4/2.0 interface

Mechanical Characteristics

- Package: DFN1616-6
- Lead Finish: Lead Free
- UL Flammability Classification Rating 94V-0
- Quantity Per Reel: 3,000pcs
- Reel Size: 7 inch

Absolute Maximum Ratings (Tamb=25°C unless otherwise specified)

Parameter	Symbol	Value	Unit
Peak Pulse Power (8/20 μs)	Ppp	100	W
ESD per IEC 61000-4-2 (Air)	V _{ESD}	± 18	Kv
ESD per IEC 61000-4-2 (Contact)		± 15	
Operating Temperature Range	T _J	-55 to +125	°C
Storage Temperature Range	T _{STJ}	-55 to +150	°C

Dimensions DFN1616-6

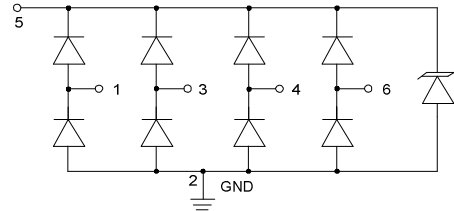

Pin Configuration

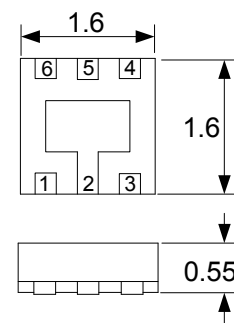

Electrical Characteristics (TA=25°C unless otherwise specified)

Part Number	Device Marking	V _{RWM} (V)	V _{BR} (V)	I _T (mA)	V _C @1A	V _C		I _R μA (Max)	C (Pf) (Typ.)
						(Max)	(@A)		
SP3012-03UTG	53P	5	6	1	10	20	5	0.5	0.4

Typical Performance Characteristics (TA=25°C unless otherwise Specified)

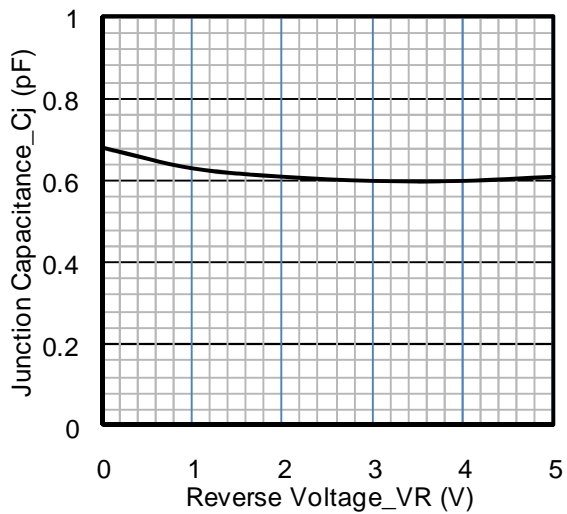

Junction Capacitance vs. Reverse Voltage

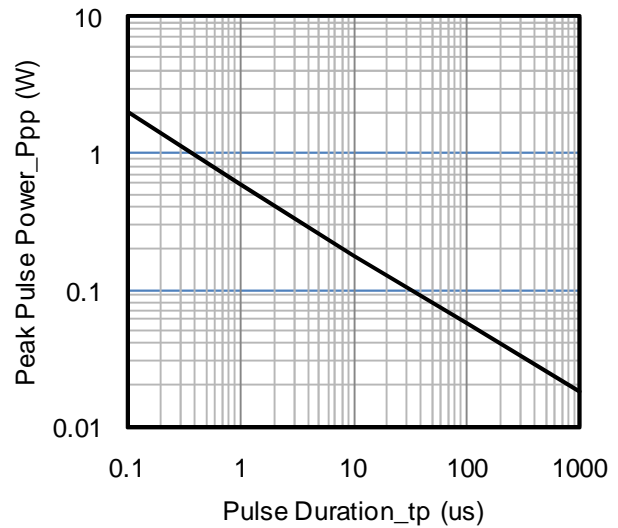

Peak Pulse Power vs. Pulse Time

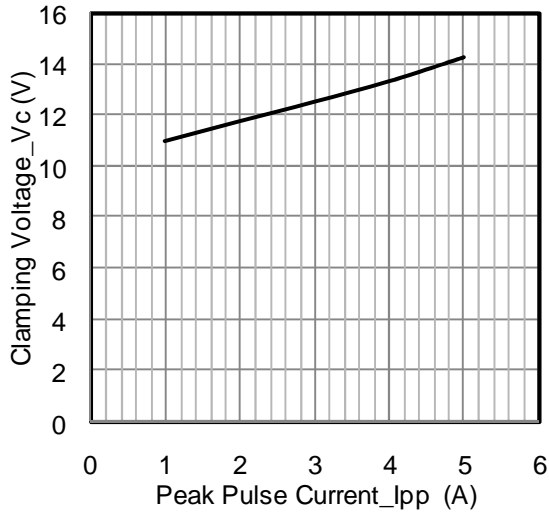

Clamping Voltage vs. Peak Pulse Current

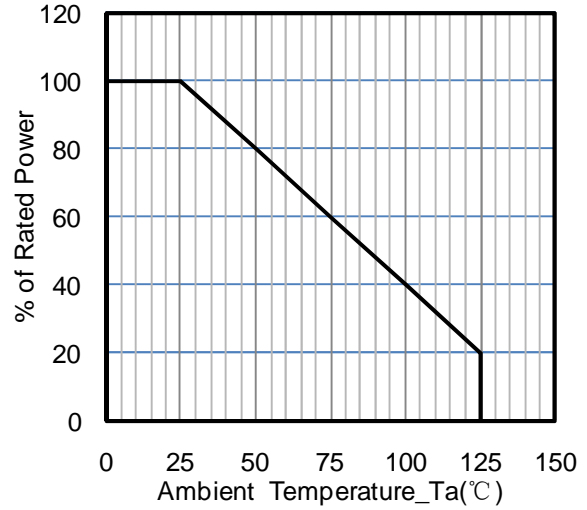

Power Derating Curve

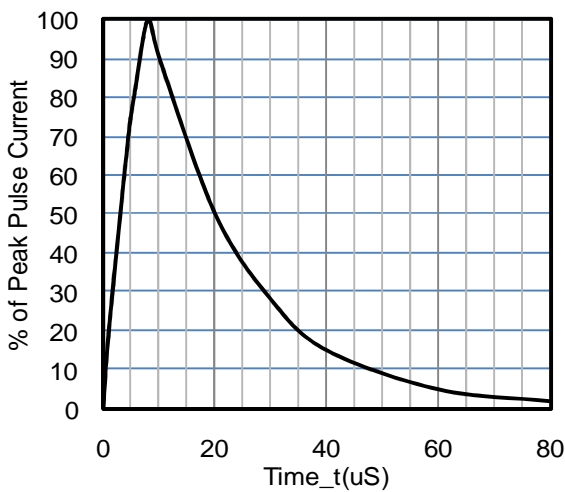

8 X 20us Pulse Waveform

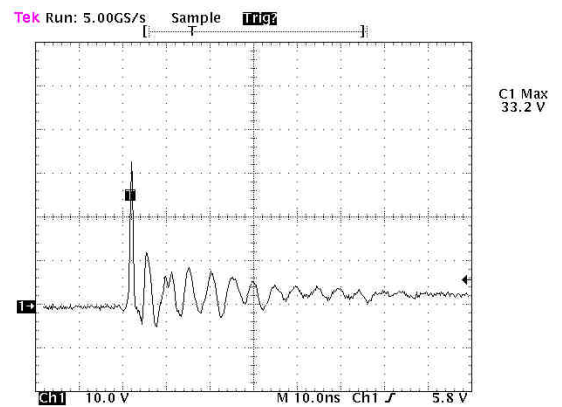

ESD Clamping Voltage

8 kV Contact per IEC61000-4-2

SP3012-03UTG on SIM Port Application

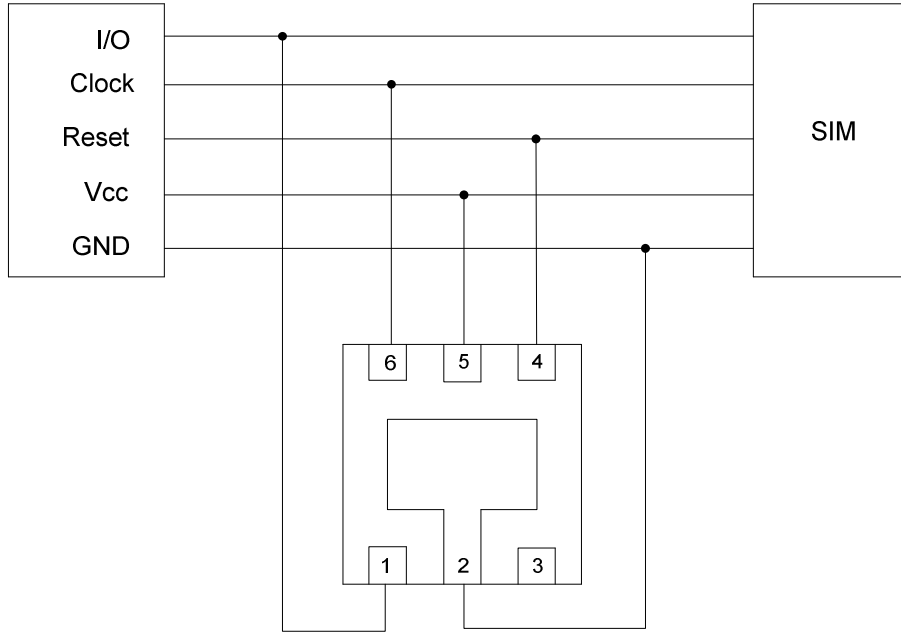

SP3012-03UTG on USB OTG Application

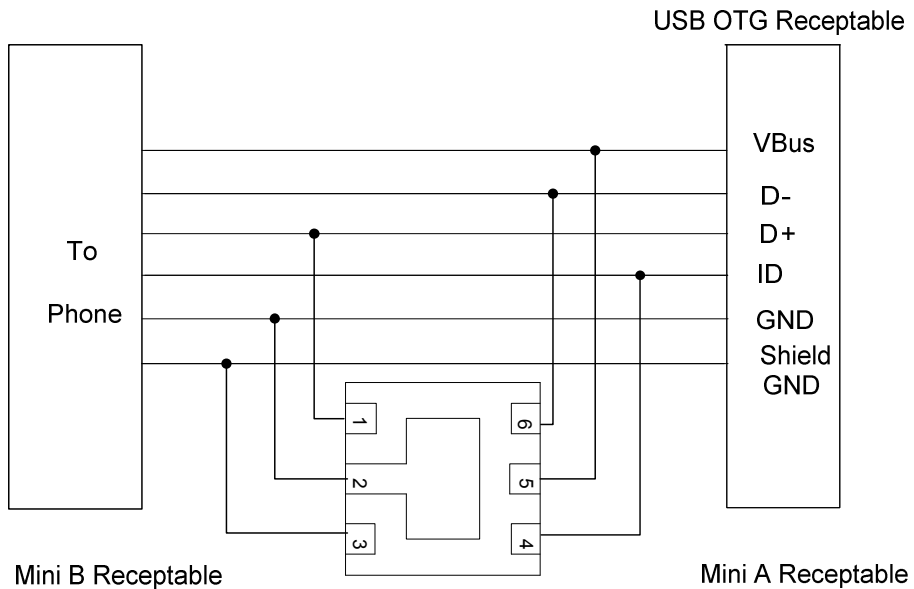

DFN1616-6 Package Outline Drawing

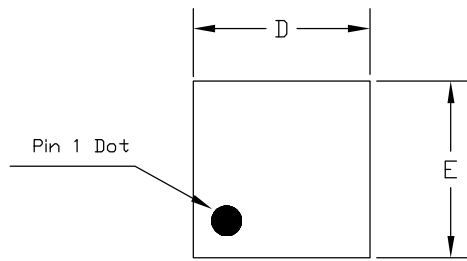

TOP VIEW

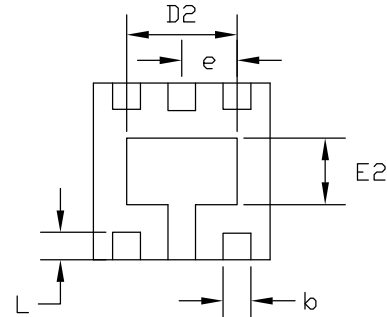

BOTTOM VIEW

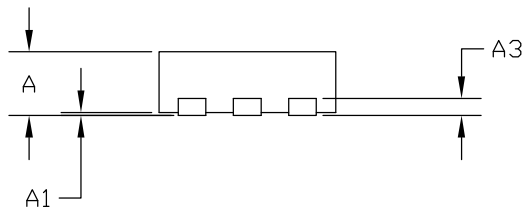

SIDE VIEW

PKG. REF.	COMMON DIMENSIONS(MM)		
	UT: ULTRA THIN		
	MIN.	NOM.	MAX
A	0.50	0.55	0.60
A1	0.00	-	0.05
A3	0.15 REF.		
D	1.55	1.60	1.65
E	1.55	1.60	1.65
D2	0.85	1.00	1.10
E2	0.45	0.60	0.70
L	0.20	0.25	0.30
b	0.20	0.25	0.30
e	0.50 BSC		

Suggested Land Pattern

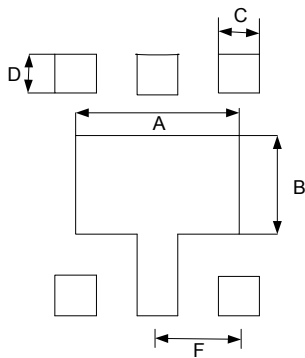

SYM	DIMENSIONS	
	MILLIMETERS	INCHES
A	1.20	0.04
B	0.72	0.020
C	0.30	0.012
D	0.30	0.032
F	0.60	0.052