

REVISION RECORD				
REV	ECN	DESCRIPTION	DRFT	DATE

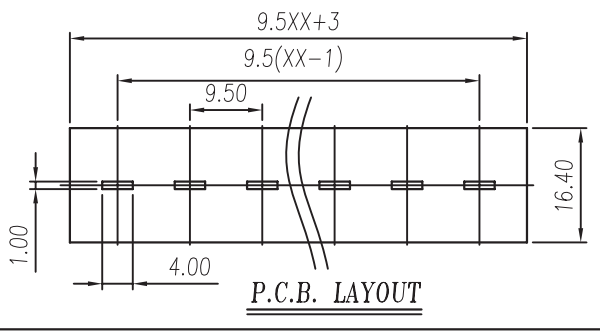

NOTES1:

- UL Standard
- 1.Rated voltage/current : 300V / 25A
- 2.Torque value : M4 , 10.53Lb.in
- 3.Wire range : 22~12AWG

NOTES2:

- 1.Dimension shall be interpreted per ASME Y14.5-2009
- 2.Pitch : 9.5mm, Poles : N=02~24P
- 3.Withstanding voltage : AC1600V/1Min
- 4.Operating temperature: -40°C~+105°C
- 5.Undimensioned tolerances:

Pitch range in mm		Nominal dimension range in mm				0.1/10
To	Over	To	Over	To	Over	
6	10	6	10	100	150	±2*
±0.15	±0.20	±0.30	±0.30	±0.50	±0.70	
±1.00	±1.30	±1.00	±1.00	±1.00	±1.30	

6.RoHS Compliance

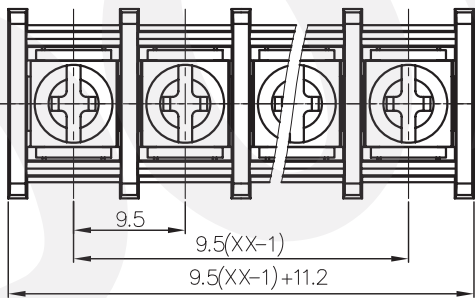
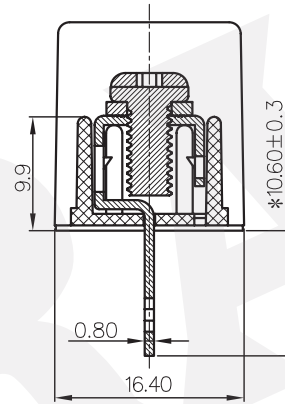
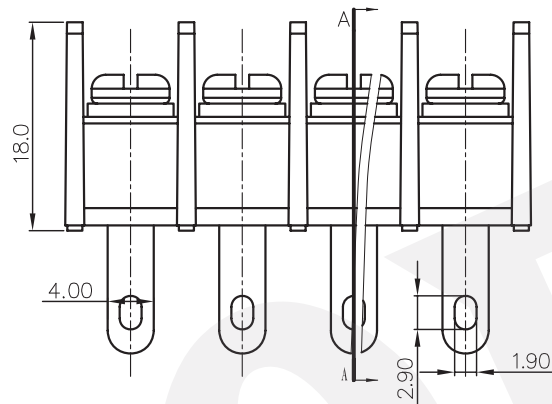

DBT30H-9.5 - XXP - 1Y - 00A (H)

(Series No.) (Poles) (Single Pitch) (Color): 1.(Grey)
 2.(Blue)
 3.(Black)
 4.(Green)
 5.(Orange)
 6.(Red)
 7.(Transparent)
 8.(Yellow)
 9.(White)

(RoHS)
 00A-(Standard)

DETACHED LISTS	PART NO.: /	DORABO 慈溪市地博电子有限公司 CIXI DORABO ELECTRONICS CO.,LTD		
	APPD: /	NAME: DBT30H-9.5-XXP-1Y-00A(H)		
	CHKD: /	TITLE: CUSTOMER DRAWING		REV: /
	DRFT: /	DRAWING NO.: /		DO: /
THIRD ANGLE PROJECTION		MM (INCH)	DO NOT SCALE DRAWING	SHEET: 1/1
			SCALE: 1:1	