

◆ **Scope**

This specification applies to the CMLO252010T Series of SMD power inductors.

◆ **Lead Free PartNumbering**

CMLO	252010	T	1R0	M	T	T
(1)	(2)	(3)	(4)	(5)	(6)	(7)

- (1) Series Type
- (2) Dimension: LxWxH
- (3) Material Code
- (4) Inductance:R68=0.68uH;1R0=1.0μH
- (5) Inductance Tolerance:M=± 20%,N=± 30%
- (6) Company Code
- (7) Packaging: packed in embossed carrier tape

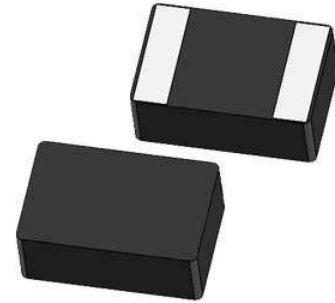

◆ **Dimensions**

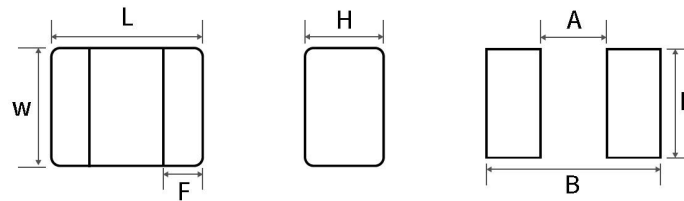

Series	L(mm)	W(mm)	H(mm)	F(mm)	Recommended Land Patterns		
					A(mm)	B(mm)	E(mm)
CMLO252010T	2.5±0.2	2.0±0.2	1.0Max.	0.9Typ.	1.0Typ.	2.8Typ.	2.1Typ.

◆ **Structural drawing**

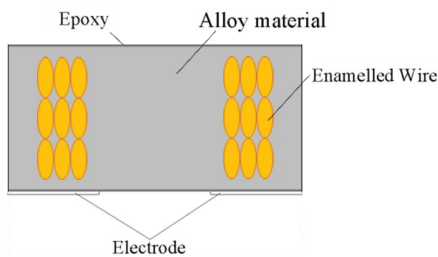

No.	Component	Material
①	Body	Alloy material
②	Winding	Enamelled Wire
③	Shield	Epoxy
④	Electric	Base plating-Cu
		Base plating-Ni
		Base plating-Sn

◆ **Specification**

Part No.	Inductance Ls(uH)	Direct Current Resistance DCR(mΩ)		Saturation Current Isat(A)	Temperature Rise Current Irms(A)
CMLO252010TR33MTT	0.33±20%	19.0 Max	13.0 Typ	7.20 Max	6.20 Max
CMLO252010TR47MTT	0.47±20%	22.0 Max	15.0 Typ	6.50 Max	5.60 Max
CMLO252010TR68MTT	0.68±20%	27.0 Max	23.0 Typ	5.50 Max	5.00 Max
CMLO252010T1R0MTT	1.0±20%	30.0 Max	25.0 Typ	4.80 Max	4.10 Max
CMLO252010T1R5MTT	1.5±20%	55.0 Max	45.0 Typ	3.90 Max	3.00 Max
CMLO252010T2R2MTT	2.2±20%	70.0 Max	62.0 Typ	3.00 Max	2.10 Max
CMLO252010T3R3MTT	3.3±20%	100.0 Max	86.0 Typ	2.50 Max	2.10 Max
CMLO252010T4R7MTT	4.7±20%	180.0 Max	160.0Typ	2.00 Max	1.60 Max

Test condition & equipment :

Item	Test condition	Test equipment
Ls	1MHz/1V	HP4263BIM3532-50 or equivalent
DCR	direct-current	HP4263BRM3545 or equivalent
Isat	1MH/1V	Microtest 6379 &6220 or equivalent
Irms	ambient temperature 20°C	Microtest 6379 &6220 or equivalent

Isat: The DC current at which the inductance drops approximate 30%from its value without current, Load current time withinLs.

Irms: The DC current is inductor surface temperature to rise by 40°C.

◆ **Operating Temperature Range**

-40°C ~+125°C ,Including self-heating

◆ **Storage Conditions**

Store products in a warehouse in compliance with the following condition:

Temperature: Inductors (product with taping) -10 to +40°C;

Inductors body -40 to +85°C.

Humidity: 30~70%RH

◆ **RECOMMENDED REFLOW PROFILE**

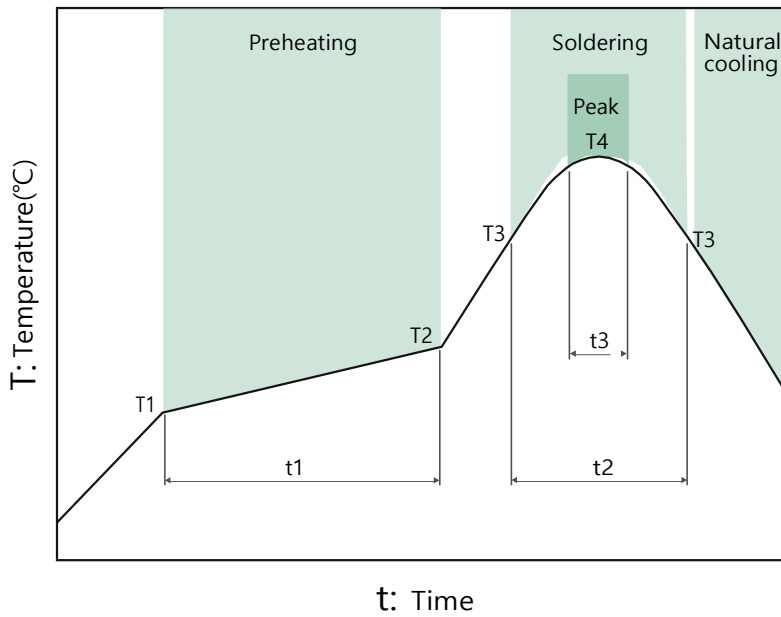

Preheating			Soldering		Peak	
Temp.		Time	Temp.	Time	Temp.	Time
T1	T2	t1	T3	t2	T4	t3
150°C	180°C	60 to 120s	230°C	30 to 50s	250 to 260°C	10s max

◆ **Reliability Mechanical**

序号 No.	项目 Items	要求 Requirements	试验方法及备注 Test Methods and Remarks
1	绝缘电阻 Insulation Resistance	$\geq 100M\Omega$	在电感器线圈和本体顶面中间施加 100 V 直流电压保持60 s。 100 V DC between inductor coil and The middle of the top surface of the body for 60 seconds.
2	可焊性 Solderability	电极面90%以上覆盖新的焊料。 90% or more of electrode area shall be coated by new solder.	在(245±5) °C 熔融的焊锡 (96.5Sn/3.0Ag/0.5Cu) 中浸(5±1)s。 Dip pads in flux and dip in solder pot (96.5Sn/3.0Ag/0.5Cu) at (245±5) °C for (5±1) seconds.
3	耐焊接热 Resistance to Soldering Heat	外观无可见机械损伤； 电感量变化率：±10%以内。 No visible mechanical damage. Inductance change: Within ±10%	在(260±5) °C 熔融的焊锡 (96.5Sn/3.0Ag/0.5Cu) 中浸(10±1) s。 Dip pads in flux and dip in solder pot (96.5Sn/3.0Ag/0.5Cu) at (260±5) °C for (10±1) seconds.
4	端子强度 Adhesion of terminal electrode	元件的端子与本体结合无松动、无脱落。 Strong bond between the pad and the core, without come off PC board.	将电感器用(260±5)°C，(20±5)s 焊在带有 0.3 mm 厚锡膏的基板上，然后用治具垂直电极面方向加压 10 N，(10±1) s。 Inductors shall be subjected to (260±5)°C for (20±5) s Soldering in the base whit 0.3mm solder. And then aplomb electrode way plus tax 10 N for (10±1) seconds.
5	耐高温 High temperature	外观无可见机械损伤； 电感量变化率：±10%以内。 No visible mechanical damage. Inductance change: Within ±10%	温度(+85 ± 2)°C, 时间(96±2) h; Temperature is (+85±2)°C and keep (96±2) hours.
6	耐低温 Low temperature	外观无可见机械损伤； 电感量变化率：±10%以内。 No visible mechanical damage. Inductance change: Within ±10%	温度(-40°C ±2)°C， 时间(96±2)h; Temperature is (-40±2)°C and keep (96±2) hours.

序号 No.	项目 Items	要求 Requirements	试验方法及备注 Test Methods and Remarks
7	温度变化 Thermal shock	外观无可见机械损伤；电感量变化率：±10%以内。 No visible mechanical damage. Inductance change: Within ±10%	(-40±3) °C,时间(30±3) min ↔ (125°C±2) °C/(30±3) min, 转换时间(2~3) min,循环32次；在室温下放置 2 小时后、48 小时内测试。 The test sample shall be placed at (-40±3)°C and (125±2)°C for (30±3)min, different temperature conversion time is 2~3 minutes. The temperature cycle shall be repeated 32 cycles. Placed at room temperature for 2 hours, within 48 hours of testing.
8	温度特性 Temperature characteristic	电感量变化率 P_{c-b}, P_{c-d} 不超过±20%。 Inductance change P_{c-b}, P_{c-d} : Within ±20%	a: +20 °C (30~45) min → b: -40 °C (30~45) min → c: +20 °C (30~45) min → d: +125 °C (30~45) min → e: +20 °C (30~45) min $P_{c-b} = \frac{L_b - L_c}{L_c} \times 100\%$; $P_{c-d} = \frac{L_d - L_c}{L_c} \times 100\%$
9	恒定湿热 Static Humidity	外观无可见机械损伤； 电感量变化率：±10%以内。 No visible mechanical damage. Inductance change: Within ±10%	将电感器放置于湿度(93±3)%RH,温度(40±2) °C的环境中存放(1000±2)h, 在室温下放置2 小时后、48 小时内测试。 Inductors shall be subjected to (93±3)%RH . at (60±2)°C for (96±2) h . Placed at room temperature for 2 hours, within 48 hours of testing.
10	耐久性 (寿命) Life	外观无可见机械损伤； 电感量变化率：±10%以内。 No visible mechanical damage. Inductance change: Within ±10%	温度(85±2)°C, 时间(1000±24)h,施加Irms, 在室温下放置2 小时后、48 小时内测试。 Inductors shall be store at (85±2)°C for (1000±24) hours with Irms applied. Placed at room temperature for 2 hours, within 48 hours of testing.

◆ **Taping reel dimensions**

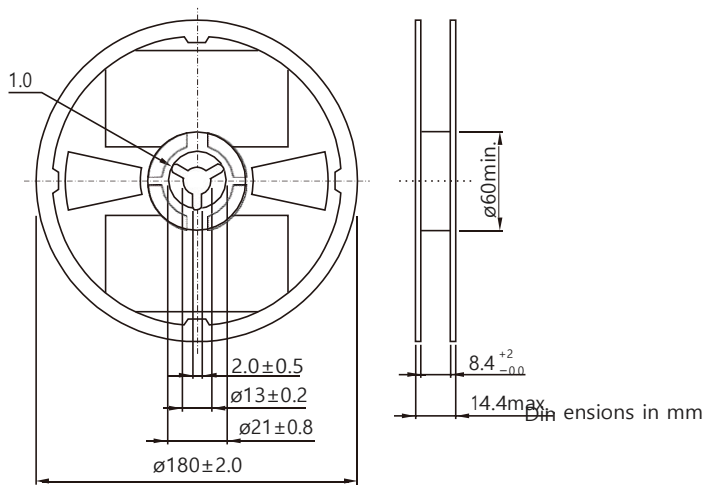

◆ **Carrier tape dimensions**

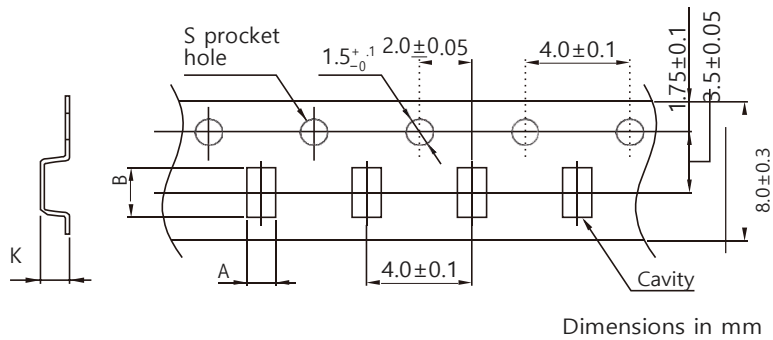

Series Type	A	B	K
CMLO252010T	2.2	2.7	1.3

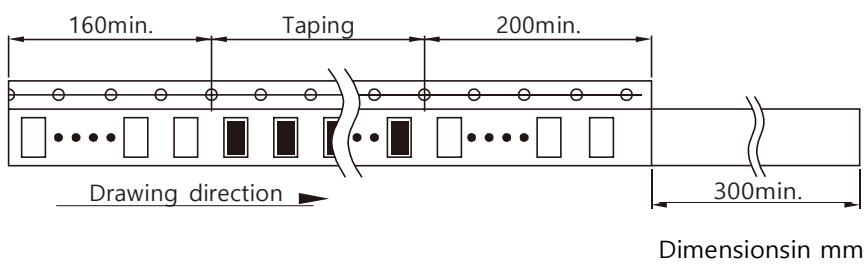

◆ **Package quantity**

Package quantity	3000 pcs/reel
------------------	---------------