



B5817WS THRU B5819WS

Schottky Barrier Rectifiers

FEATURES

- Metal silicon junction, majority carrier conduction
- Guarding for overvoltage protection
- Low power loss, high efficiency
- High current capability
- low forward voltage drop
- High surge capability
- For use in low voltage, high frequency inverters, free wheeling, and polarity protection applications

PIN	DESCRIPTION
1	Cathode
2	Anode

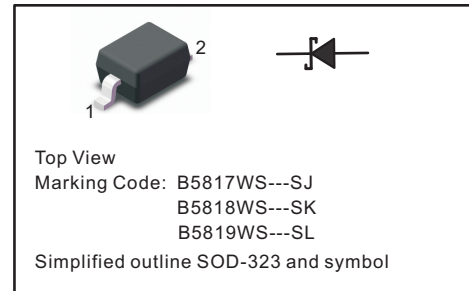

MECHANICAL DATA

- Case: SOD-323
- Terminals: Solderable per MIL-STD-750, Method 2026
- Approx. Weight: 5.48mg / 0.00019oz

MAXIMUM RATINGS AND ELECTRICAL CHARACTERISTICS

Ratings at 25 °C ambient temperature unless otherwise specified.

Parameter	Symbols	B5817WS	B5818WS	B5819WS	Units
Maximum Repetitive Peak Reverse Voltage	V_{RRM}	20	30	40	V
Maximum RMS voltage	V_{RMS}	14	21	28	V
Maximum DC Blocking Voltage	V_{DC}	20	30	40	V
Maximum Average Forward Rectified Current	$I_{F(AV)}$	1			A
Peak Forward Surge Current, 8.3ms Single Half Sine-wave Superimposed On Rated Load (JEDEC method)	I_{FSM}	9			A
Maximum Instantaneous Forward Voltage at 1 A at 3 A	V_F	0.45 0.75	0.55 0.875	0.6 0.9	V
Maximum Instantaneous Reverse Current at $T_A = 25^\circ\text{C}$ Rated DC Reverse Voltage $T_A = 100^\circ\text{C}$	I_R	1 10			mA
Typical Junction Capacitance	C_j	110			pF
Storage and Operating Junction Temperature Range	T_j, T_{stg}	-55 ~ +150			°C



B5817WS THRU B5819WS Schottky Barrier Rectifiers

Characteristic Curves ($T_A=25\text{ }^\circ\text{C}$ unless otherwise noted)

Fig.1 Forward Current Derating Curve

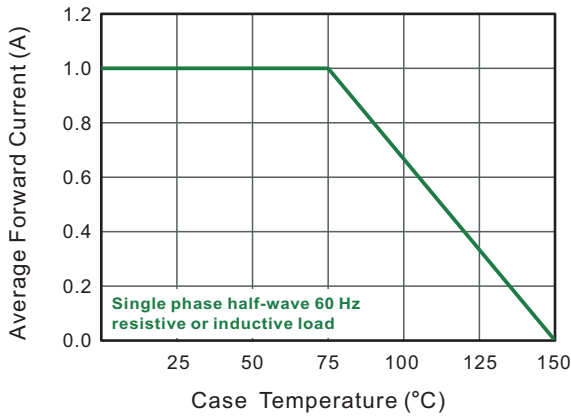

Fig.2 Typical Reverse Characteristics

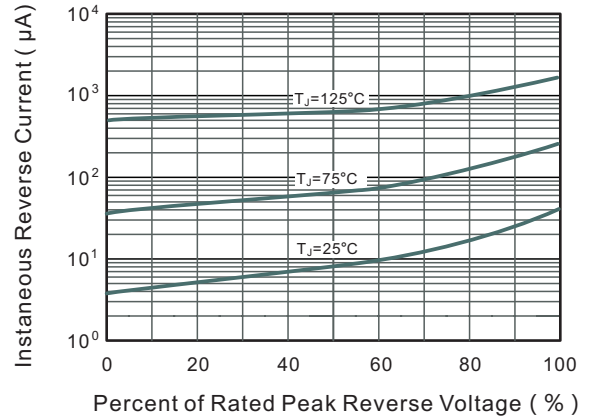

Fig.3 Typical Forward Characteristic

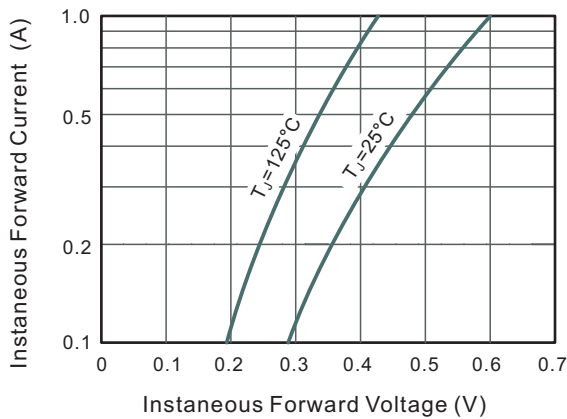

Fig.4 Typical Junction Capacitance

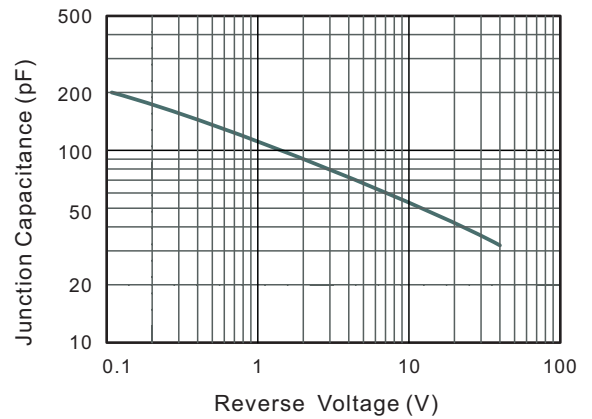
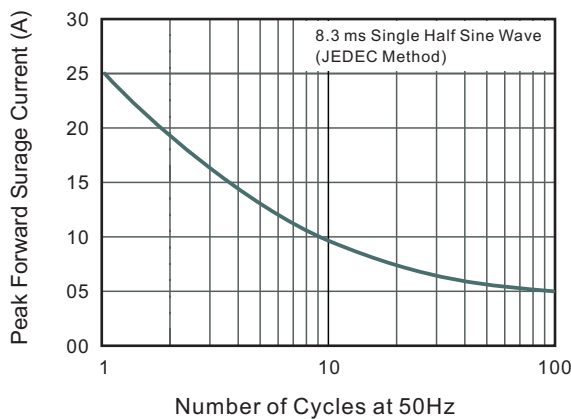

Fig.5 Maximum Non-Repetitive Peak Forward Surge Current





B5817WS THRU B5819WS Schottky Barrier Rectifiers

PACKAGE OUTLINE

Plastic surface mounted package; 2 leads

SOD-323

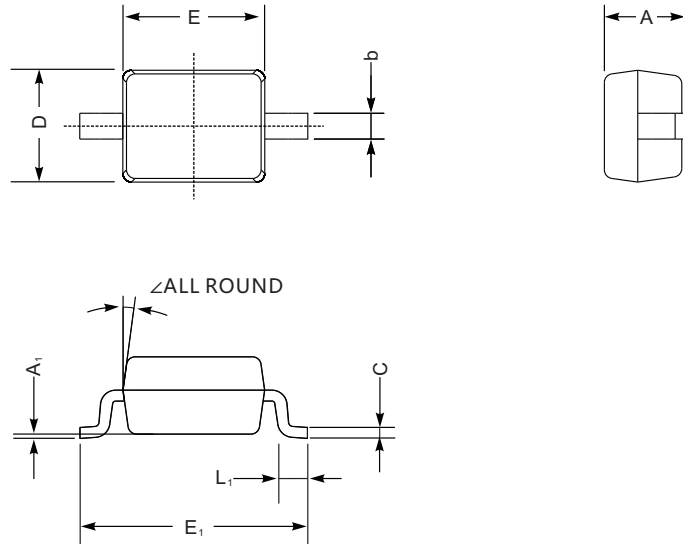

SOD-323 mechanical data

UNIT		A	C	D	E	E ₁	b	L ₁	A ₁	∠
mm	max	1.1	0.15	1.4	1.8	2.75	0.4	0.45	0.2	9°
	min	0.8	0.08	1.2	1.4	2.55	0.25	0.2	—	
mil	max	43	5.9	55	70	108	16	16	8	
	min	32	3.1	47	63	100	9.8	7.9	—	

The recommended mounting pad size

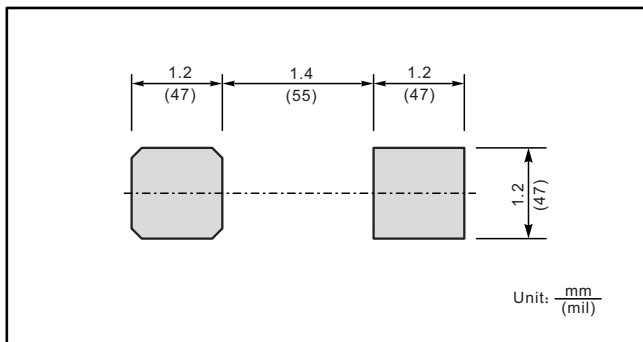

Marking

Type number	Marking code
B5817WS	SJ
B5818WS	SK
B5819WS	SL