

FWP252010P L Series Engineering Specification



1. Scope

Feature

- High saturation current realized by material properties and structure design
- Low DC resistance to achieve high conversion efficiency and lower temperature rising
- Low Profile: 2.5 mm × 2.0 mm × 1.0 mm.
- Magnetically shielded structure to accomplish high resolution in EMC protection.
- Halogen free, Lead Free, RoHS Compliance.

Applications

FWP252010P L series is generic applied in portable DC to DC converter line.

- Smart phone, PAD
- DC/DC converter
- Thin-type power supply module,

2. Explanation of Part Number

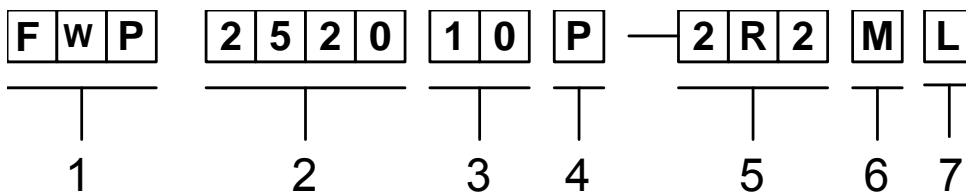

- ◆ 1 : Series Name: Wire-wound type power inductor
- ◆ 2 : Size Code: The first two digitals: length(mm), The last two digitals: width(mm)
- ◆ 3 : Thickness in mm
- ◆ 4 : Material code: Iron powder
- ◆ 5 : Initial inductance value: 2R2 = 2.2 μH
- ◆ 6 : Model code, Tolerance of Inductance ±20%.
- ◆ 7 : Electrode type.

3. Construction & Dimensions

3.1. End termination: Ni/Sn

3.2. Construction & Dimension :

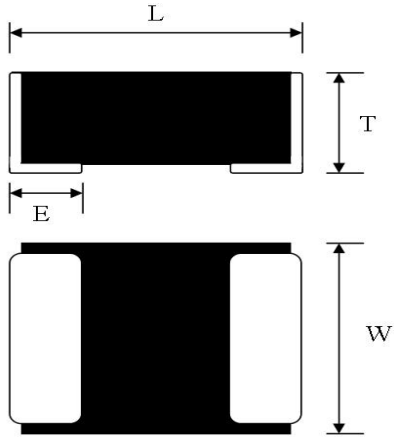

L [mm]	W [mm]	T [mm]	E [mm]
2.5±0.2	2.0±0.2	1.0 max.	0.6±0.2

3.3. Recommend Land Pattern Dimensions :

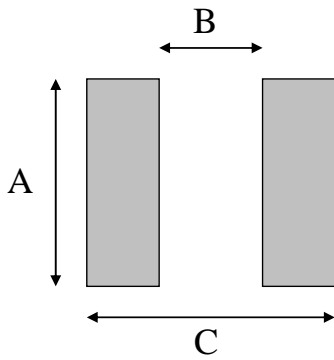

A [mm]	B [mm]	C [mm]
2.0	1.2	2.8.

4. General specifications

4.1. Temperature Specifications

Operating Temperature range : -40°C to +125°C
 Storage Temperature range : -50°C to +125°C

* The detail operating temperature describing can refer to 5.1 (7).

5. Performance Characteristics

5.1. Specifications

Part Number	Li [μ H] Initial inductance @1mA	RDC [$m\Omega$] DC Resistance		Isat [A] Saturation Current		Irms [A] Heat Rating Current	
		Typical	Maximum	Typical	Maximum	Typical	Maximum
FWP252010P-R33ML	0.33	21	26	6.6	6	4.4	4.0
FWP252010P-R47ML	0.47	27	32	5	4.50	3.9	3.51
FWP252010P-R68ML	0.68	37	44	4.3	3.87	3.3	2.97
FWP252010P-1R0ML	1.0	45	54	3.5	3.15	2.8	2.52
FWP252010P-1R5ML	1.5	76	91	2.6	2.34	2.5	2.25
FWP252010P-2R2ML	2.2	99	119	2.4	2.16	2.3	2.07
FWP252010P-4R7ML	4.7	220	262	1.8	1.62	1.36	1.22

Note 1: Customized design is available, please contact us.

Note 2: All test referenced to 26°C ambient

Note 3: Inductance tolerance +/- 20%

Note 4: Inductance is measured with Agilent® LCR meter 4285A. Test frequency at 1MHz.

Note 5: DC resistance is measured with HIOKI® micro-ohm meter RM3542-01.

Note 6: Isat means that DC current will cause a 30% inductance reduction form initial value.

Note 7: Irms means that DC current will cause coil temp. rising to 40°C whichever is smaller.

5.2. Current Characteristic

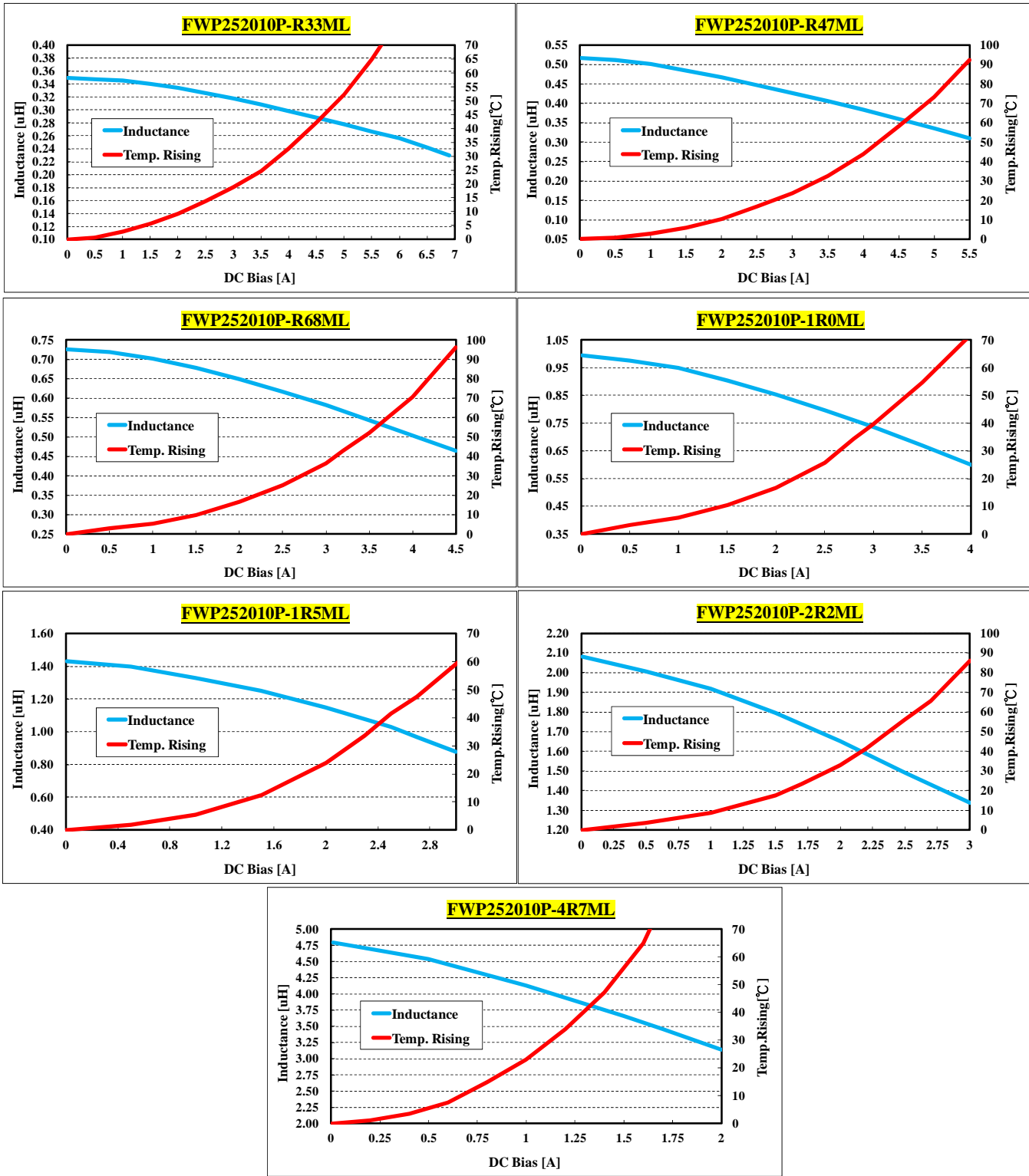

6. Reliability and Test Condition

Test item	Test condition	Criteria
Resistance to Solder Heat	<ol style="list-style-type: none"> Solder temperature : $260 \pm 5^{\circ}\text{C}$ Flux : Rosin DIP time : 10 ± 1 sec 	<ol style="list-style-type: none"> More than 95 % of terminal electrode should be covered with new solder No mechanical damage Inductance value should be within ± 20 % of the initial value
Adhesive Test	<ol style="list-style-type: none"> Reflow temperature : 245°C It shall be Soldered on the substrate applying direction parallel to the substrate Apply force(F) : 5 N Test time : 10 sec 	<ol style="list-style-type: none"> No mechanical damage Soldering the products on PCB after the pulling test force > 5 N
Temperature Cycle	<ol style="list-style-type: none"> Temperature: $-50 \sim 125^{\circ}\text{C}$ For 30 minutes each Cycle: 500 cycles Measurement: At ambient temperature 24 hours after test completion 	<ol style="list-style-type: none"> No mechanical damage Inductance should be within $\pm 20\%$ of the initial value
Dry Heat Test	<ol style="list-style-type: none"> Temperature: $85 \pm 2^{\circ}\text{C}$ Testing time: 500 hrs Applied current: Full rated current Measurement: At ambient temperature 24 hours after test completion 	<ol style="list-style-type: none"> No mechanical damage Inductance should be within $\pm 20\%$ of the initial value
Humidity Test	<ol style="list-style-type: none"> Temperature: $60 \pm 2^{\circ}\text{C}$ Humidity: 90-95 % RH Applied current: Full rated current Testing time: 500 hrs Measurement: At ambient temperature 24 hours after test completion 	<ol style="list-style-type: none"> No mechanical damage Inductance should be within $\pm 20\%$ of the initial value

7. Taping Package and Label Marking

7.1. Carrier tape dimensions

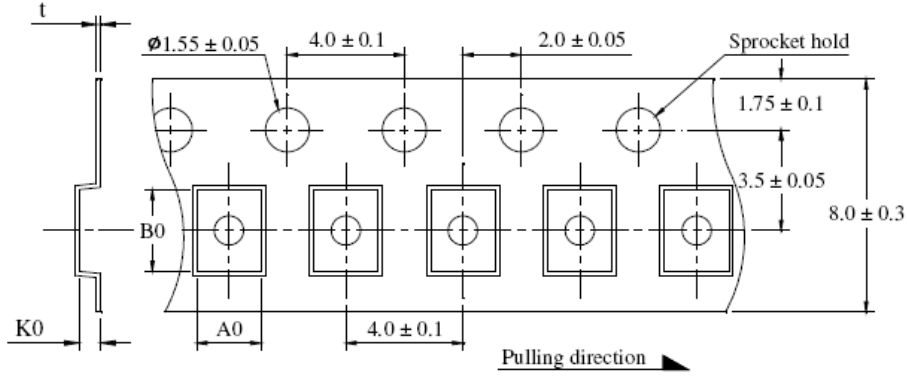

	A0	B0	K0	t
mm	2.5 ± 0.1	3.0 ± 0.1	1.6 ± 0.10	0.25 ± 0.05

7.2. Taping reel dimensions

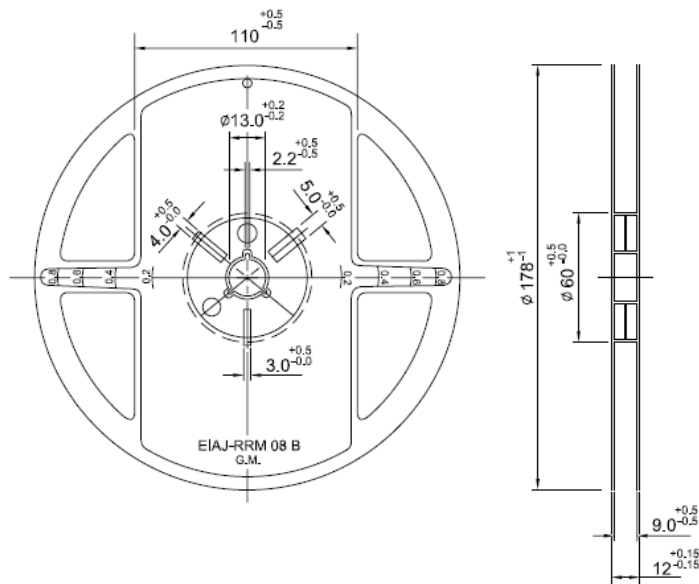

PART SIZE (EIA SIZE)	2520 (1008)
Qty.(pcs)	3,000
BOX	5 reels / inner box

7.3. Taping specifications

There shall be the portion having no product in both the head and the end of taping, and there shall be the cover tape in the head of taping.

7.4. Label Marking

The label specified as follows shall be put on the side of reel.

(1) Part No.

(2) Quantity

(3) Lot No.

* Part No. And Quantity shall be marked on outer packaging.

7.5. Quantity of products in the taping package

(1) Standard quantity : 3000pcs/Reel

(2) Shipping quantity is a multiple of standard quantity.

8. Precautions for Handling

8.1. Precaution for handling of substrate

Do not exceed to bend the board after soldering this product extremely.
(reference examples)

- Mounting place must be as far as possible from the position, which is close to the break line of board, or on the line of large holes of board.
- Do not bend extremely the board, in mounting another components.
If necessary, use back-up pin (support pin) to prevent from bending extremely.
- Do not break the board by hand. We recommend to use the machine or the jig to break it.

8.2. Precaution for soldering

Note that this product will be easily damaged by rapid heating, rapid cooling or local heating.

Do not give heat shock over 100°C in the process of soldering. We recommend to take preheating and gradual cooling.

8.3. Recommendable reflow soldering

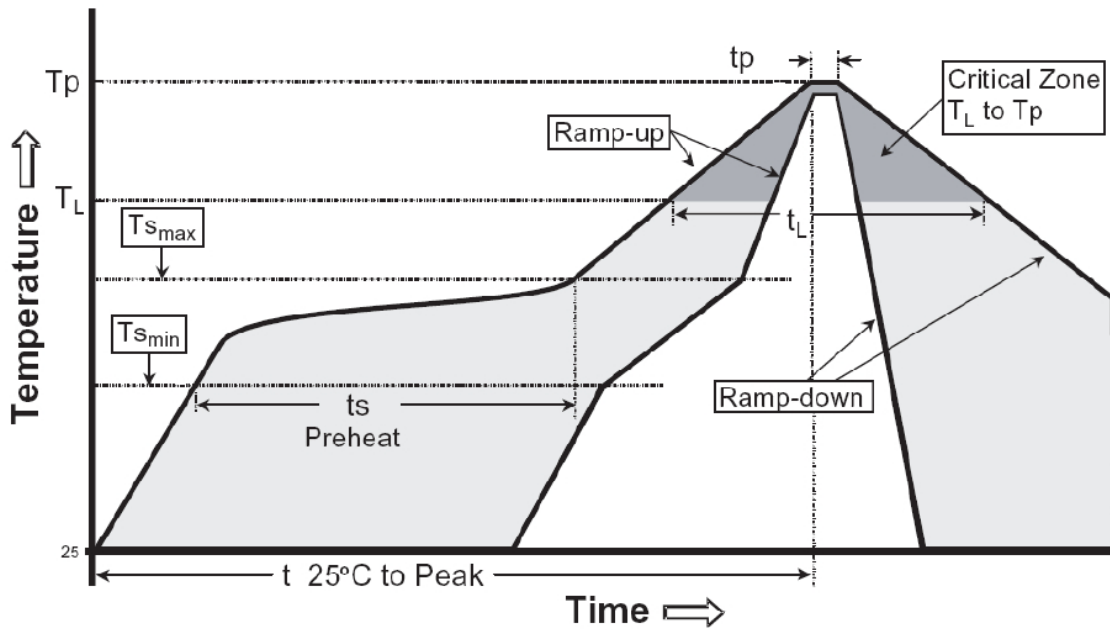

Reference IPC-020c-5-1

Profile Feature	Pb free Assembly
Average Ramp Rate (Ts max to Tp)	3 °C/second max
Preheat	
- Temperature Min (T _{smin})	150°C
- Temperature Min (T _{smax})	200°C
- Time(t _{smin} to t _{smin})	60-180 seconds
Time maintained above:	
- Temperature (T _L)	217°C
- Time (t _L)	60-150 seconds
Peak Temperature (T _p)	260°C +0/-5 °C
Time within 5 °C of actual Peak Temperature (T _p)	20-40 seconds
Ramp-Down Rate	6 °C/second max.
Time 25°C to Peak Temperature	8 minutes max

8.4. Soldering gun procedure

Note the follows, in case of using solder gun for replacement.

- (1) The tip temperature must be less than 280°C for the period within 3 seconds by using soldering gun under 30 W.
- (2) The soldering gun tip shall not touch this product directly.

8.5. Soldering volume

Note that excess of soldering volume will easily get crack the body of this product.

8.6. Taping Package Storage Condition

Storage Temperature : 5 to 40 °C

Relative Humidity: < 65%RH

Storage Time : 12 months max