

## SuperESD - AZ5013-01F

### 1. Description

The AZ5013-01F is designed to protect voltage sensitive components from damage or latch-up due to ESD. Excellent clamping capability, low leakage, and fast response time provide best in class protection on designs that are exposed ESD for board level. Because of its small size and bi-directional design, it is ideal for use in cellular phones, MP3 players, and portable applications that require audio line protection.

### 2. Features

- IEC 61000-4-2 Level 4 ESD Protection
  - ±25kV Contact Discharge
  - ±25kV Air Discharge
- 80W Peak pulse Power (8/20us)
- Low clamping voltage
- Working voltage: 3.3V
- Low leakage current
- RoHS compliant
- Protecting one bi-directional lines
- Junction capacitance: 15pF Typ.

### 3. Applications

- Cellular handsets and accessories
- Portable Digital Assistants
- Notebooks & Handhelds
- Digital Cameras
- MP3 Players
- Peripherals

### 4. Ordering Information

Part Number	Package	Marking	Material	Packing	Quantity per reel	Flammability Rating	Reel Size
AZ5013-01F	DFN1006-2L	T	Halogen free	Tape & Reel	10,000 PCS	UL 94V-0	7 inches

Table-1 Ordering information

## 5. Pin Configuration and Functions

Pin	Name	Description	Outline	Circuit Diagram
1	IO1	Connect to IO		
2	IO2	Connect to IO		

Table-2 Pin configuration

## 6. Specification

### 6.1. Absolute Maximum rating

Over operating free-air temperature range (unless otherwise noted)

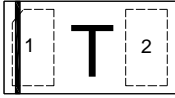
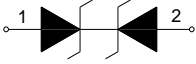
Parameters	Symbol	Min.	Max.	Unit
Peak pulse power (tp=8/20us)@25°C	P <sub>pk</sub>	-	80	W
Peak pulse current (tp=8/20us)@25°C	I <sub>PP</sub>		6	A
ESD (IEC61000-4-2 air discharge) @25°C	V <sub>ESD</sub>	-	±25	kV
ESD (IEC61000-4-2 contact discharge) @25°C	V <sub>ESD</sub>	-	±25	kV
Junction temperature	T <sub>J</sub>	-	150	°C
Operating temperature	T <sub>OP</sub>	-40	125	°C
Storage temperature	T <sub>STG</sub>	-55	150	°C
Lead temperature	T <sub>L</sub>	-	260	°C

Table-3 Absolute Maximum rating

## 6.2. Electrical Characteristics

At TA = 25°C unless otherwise noted

Parameter	Symbol	Conditions	Min.	Typ.	Max.	Units
Reverse Stand-off Voltage	$V_{RWM}$				3.3	V
Reverse Breakdown Voltage	$V_{BR}$	$I_T=1mA$	3.7			V
Reverse Leakage Current	$I_R$	$V_{RWM}=3.3V$			1	$\mu A$
Clamping Voltage	$V_C$	$I_{PP}=1A; t_p=8/20\mu s$		7		V
Clamping Voltage	$V_C$	$I_{PP}=6A; t_p=8/20\mu s$		10		V
Junction Capacitance	$C_J$	I/O to GND; $V_R=0V; f=1MHz$		15		pF

Table-4 Electrical Characteristics

Symbol	Parameters
$V_{RWM}$	Peak Reverse Working Voltage
$I_R$	Reverse Leakage Current @ $V_{RWM}$
$V_{BR}$	Breakdown Voltage @ $I_T$
$I_T$	Test Current
$I_{PP}$	Maximum Reverse Peak Pulse Current
$V_C$	Clamping Voltage @ $I_{PP}$

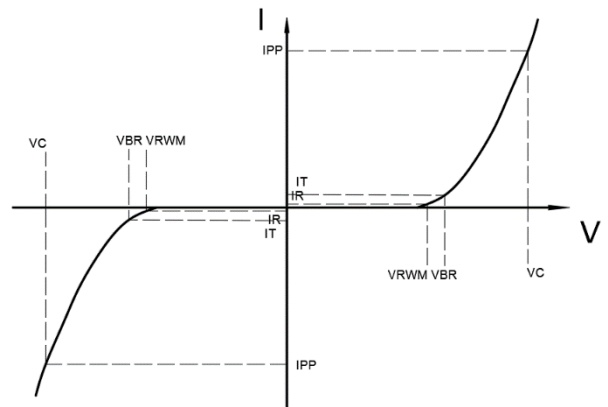

**7. Typical Characteristic**

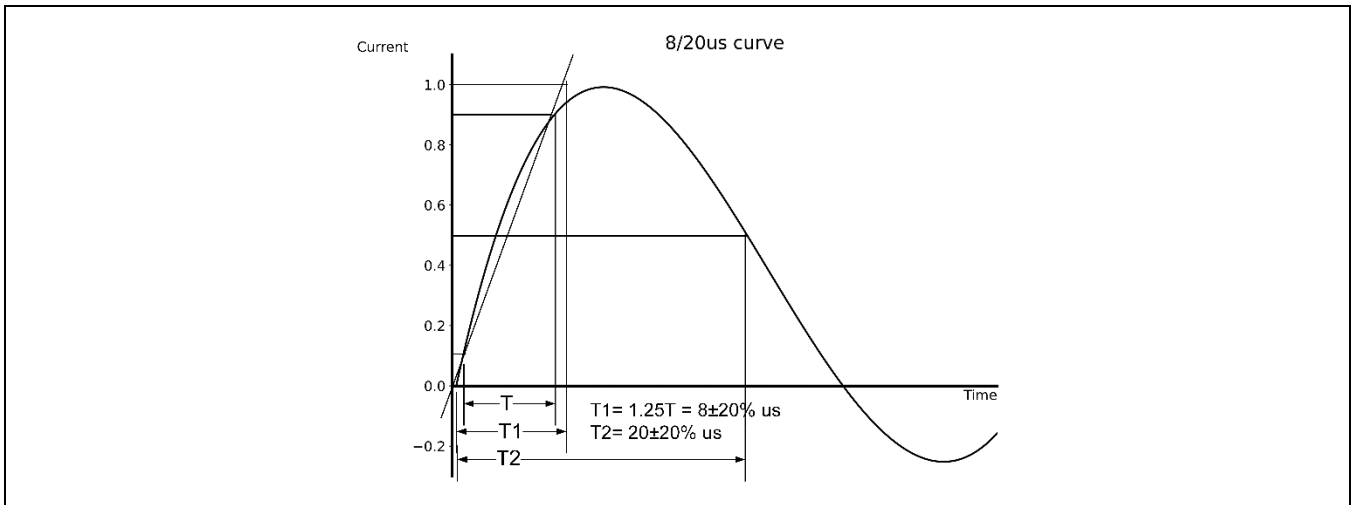

**8. Typical Application**

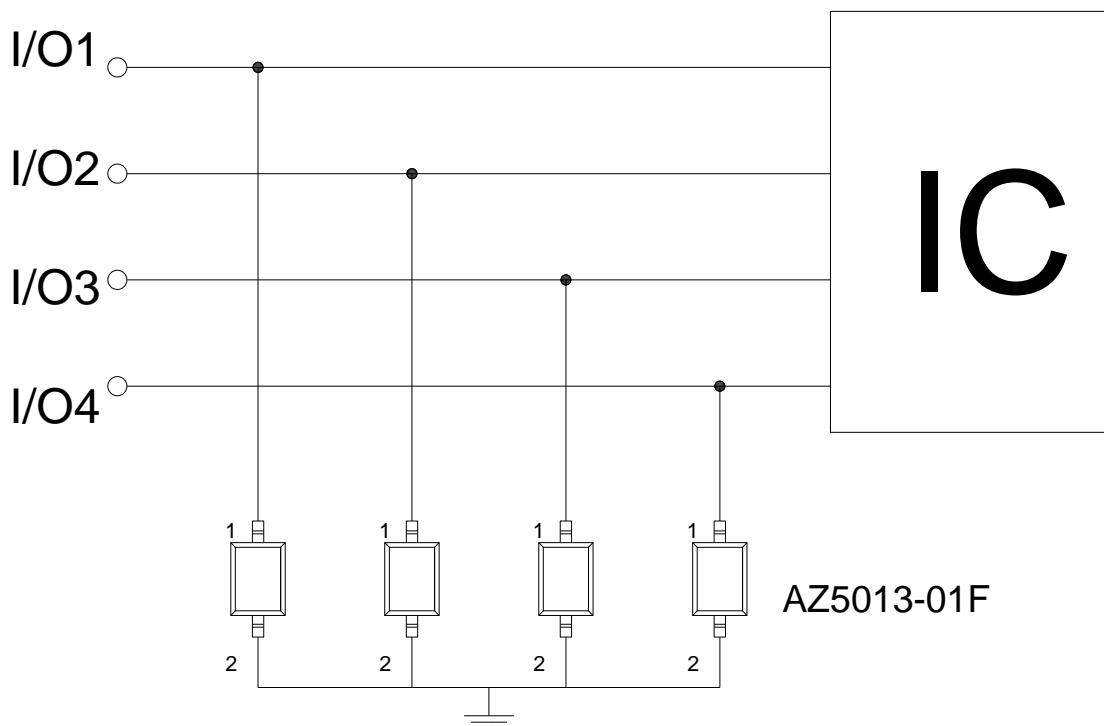

Typical Interface Application

**9. Dimension**

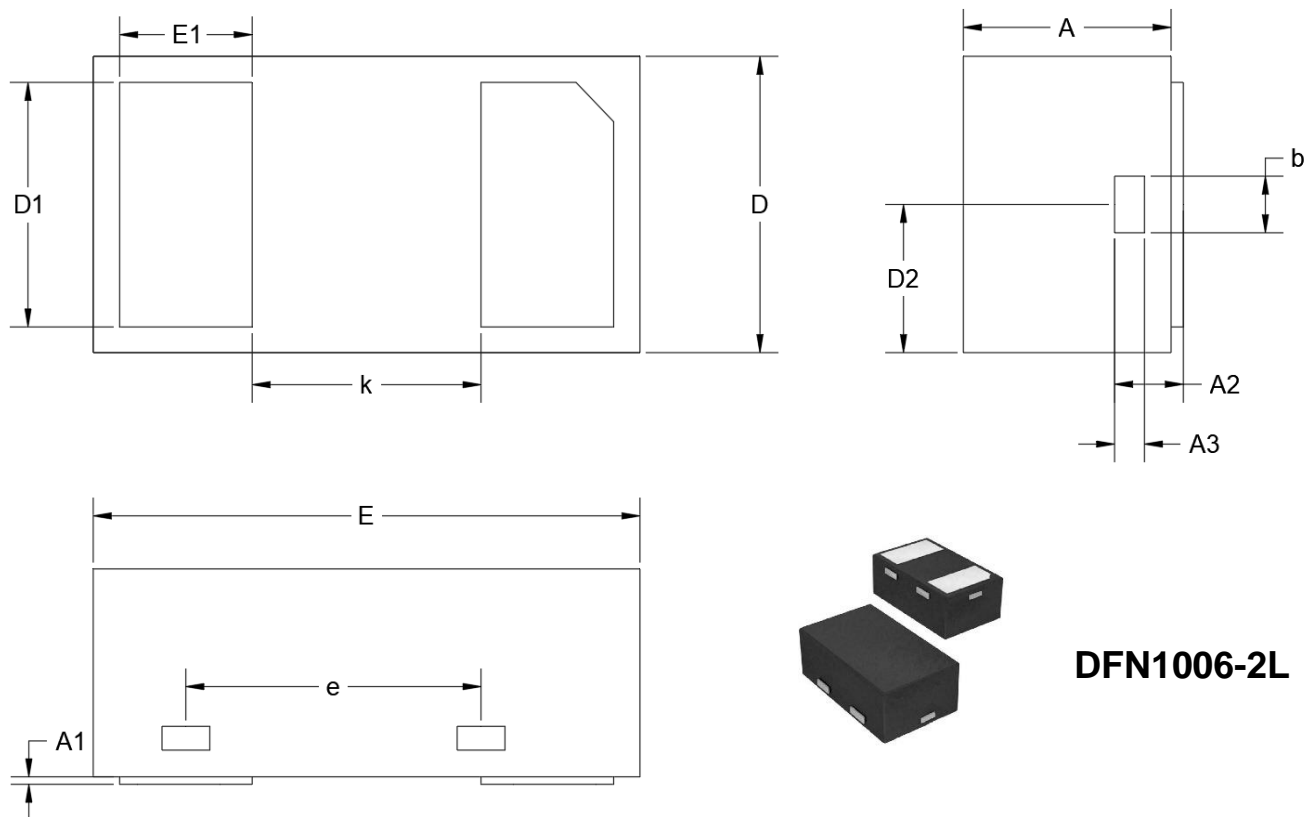

**DFN1006-2L**

Units in millimeters

Symbol	Min.	Nom.	Max.
A	0.350	0.450	0.550
A1	0.000	0.020	0.050
A2	0.077	0.127	0.207
A3	0.013	0.063	0.113
b	0.070	0.120	0.200
D	0.500	0.600	0.700
D1	0.400	0.500	0.600
D2	0.200	0.300	0.400
E	0.900	1.000	1.100
E1	0.150	0.250	0.350
e	0.460	0.510	0.560
k	0.300	0.400	0.500

Table-6 product dimensions

## 10. Recommended Land Pattern

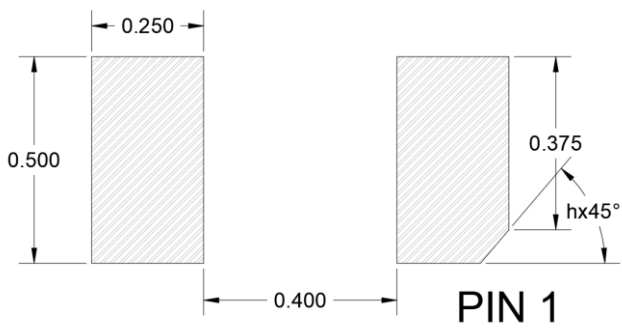
**Note:**

1. Controlling dimension: in millimeters
2. General tolerance:  $\pm 0.05\text{mm}$
3. The pad layout is for reference only

**DISCLAIMER**

ELECSUPER PROVIDES TECHNICAL AND RELIABILITY DATA (INCLUDING DATASHEETS), DESIGN RESOURCES (INCLUDING REFERENCE DESIGNS), APPLICATION OR OTHER DESIGN ADVICE, SAFETY INFORMATION, AND OTHER RESOURCES “AS IS” AND WITH ALL FAULTS, AND DISCLAIMS ALL WARRANTIES, EXPRESS AND IMPLIED, INCLUDING WITHOUT LIMITATION ANY IMPLIED WARRANTIES OF MERCHANTABILITY, FITNESS FOR A PARTICULAR PURPOSE OR NON-INFRINGEMENT OF THIRD PARTY INTELLECTUAL PROPERTY RIGHTS.

These resources are intended for skilled developers designing with ElecSuper products. You are solely responsible for

- (1) selecting the appropriate ElecSuper products for your application;
- (2) designing, validating and testing your application;
- (3) ensuring your application meets applicable standards, and any other safety, security, or other requirements.

These resources are subject to change without notice. ElecSuper grants you permission to use these resources only for development of an application that uses the ElecSuper products described in the resource. Other reproduction and display of these resources are prohibited. No license is granted to any other ElecSuper intellectual property right or to any third party intellectual property right. ElecSuper disclaims responsibility for, and you will fully indemnify ElecSuper and its representatives against, any claims, damages, costs, losses, and liabilities arising out of your use of these resources. ElecSuper’s products are provided subject to ElecSuper’s Terms of Sale or other applicable terms available either on [www.elecsuper.com](http://www.elecsuper.com) or provided in conjunction with such ElecSuper products. ElecSuper’s provision of these resources does not expand or otherwise alter ElecSuper’s applicable warranties or warranty disclaimers for ElecSuper products.