



CONQUER
功得電子

規格書

Specification For Approval

Spec NO. SFA029-014

型 號： SEF(G)系列

快速型瓷管保險絲

Model： SEF(G) Series

Fast Acting Ceramic Surface Mount Fuse

Conquer Electronics Co., Ltd.

五股廠

24888 台灣新北市五股區五權五路26 號(新北產業園區)
No.26, Wucyuan 5th Rd., Wugu Dist.,
New Taipei City 24888, Taiwan

T +886-2-8990-2189(代表號)

F +886-2-8990-2577

E cqservice@conquer.com.tw

W www.conquer.com.tw

北投廠

11259 台灣台北市北投區立德路120巷15 號
No. 15, Lane 120, Lite Road, Peitou,
11259, Taipei, Taiwan

T +886-2-2895-8895(代表號)

F +886-2-2895-8880

E cqservice@conquer.com.tw

W www.conquer.com.tw



REV.	Description	Date	Drawn	Designed	Checked	Approved
1	(1) Issue	2017.12.05	熊宏偉	邱俊傑	蔡進義	葉煥益
2	(1) 更新封面格式 (2) 更換LOGO (3) 修改項目順序 (4) 修改項目10重整安培數、安規、修改阻值中心變範圍及新增I ² t值	2019.5.22	林威廷	彭彥鳴	蔡進義	葉煥益

Conquer Electronics Co., LTD.

No.26, Wucyuan 5th Rd., Wugu Dist.,(New Taipei Industrial Park) New Taipei City 24888, Taiwan TEL:+886-2-8990-2189 (代表號) FAX:+886-2-8990-2577

Peitou Factory : No. 15, Lane 120, Lite Road, Peitou, 11248, Taipei, Taiwan. TEL: +886-2-2895-8895 (代表號) FAX:+886-2-2895-8880

E-mail: conqfuse@ms62.hinet.net Official Website: <http://www.conquer.com.tw>

~ 筒管狀保險絲 ~

Fuses for Instrument, Power and Telephone (Non-indicating)

1 適用範圍 Applications:

本標準適用於保護儀器、電源供應器和電話機用之筒管式熔斷保險絲。
For protecting instruments, power supplies and telephone sets.

2 形狀及尺寸 Shape & Dimensions:

Recommended pad layout(mm)

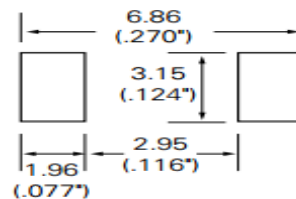
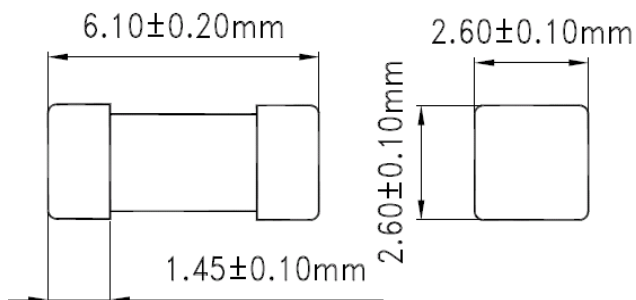

- 2.1 構造形狀 Structure & Shape : 如上圖 As shown in figure above
- 2.2 額定電壓 Voltage Rating : 125V/86V/65V
- 2.3 額定電流 Ampere Rating: 0.062A~25A

3 材料 Material:

- 3.1 筒管本體: 不透明瓷管不可破裂或變形。
Tube (Body): Non-Transparent ceramic tube fuse. No breaking or deformation is allowed.
- 3.2 兩端銅帽: 需以導電率良好之黃銅為材料。
Two brass end caps: Made of brass of good conductivity.
- 3.3 銀合金線: 可熔體保險絲線。
Silver Alloy: Fuse element.

SEF Series

Part Name	部品名稱	Volume	數量
Square Cap	- Gold Plating	2	
方型銅帽	- 鍍金		
Square Ceramic Tube	- Non-Transparent Ceramic	1	
方型瓷管	- 不透明瓷管		
Fuse Element		1	
可熔體			

4 電氣特性 Electrical Characteristics:

4.1 負載容量:通過額定電流值100%(亦即 $1.0 \times I_n$ A),能繼續通電至少4小時無任何熔化現象。
Loading Capacity: Loading 100% Rated Current (i.e. $1.0 \times I_n$ A) for flowing, and it's available to let current keep on flowing at least 4 hour without any melting. (Can keep 4 Hour minimum)

4.2 溫度特性 Temperature:

通過額定電流值100%(亦即 $1.0 \times I_n$ A)1.5小時,繼續維持原加之電流,每隔十分鐘測試一次,連續測三次,溫度不得升高,若使用熱偶式測量方法,(Thermocouple method)則本體溫升在175K以下。

Loading the 100% ($1.0 \times I_n$ A) for 1.5 hours, keep testing it with the original current every 10 minutes. Continue to test it for 3 times. The temperature is not allowed to be higher. The main temperature rise is below 175K by way of thermocouple method.

4.3 過載熔斷 Melting due to Overloading:

請參照下表。Details as Follows Table.

※最大熔斷時限 Operating Characteristics

安培數 Ampere Rating	100% Rating		200% Rating	
	Min.	Max.	Min.	Max.
0.062A~10A	4 Hr			5 sec
12A~25A	4 Hr			60 sec

5 機械特性 Mechanical Properties:

拉力強度 Terminal Strength:

當施加軸拉力720g/cm或10牛頓於兩端附腳(或銅帽),無鬆動或損壞現象發生。

Leads and/or caps are soldered (adhered) to withstand axial pulling force of 720g/cm or 10N without loosening or any harmfulness to firmly attachment.

6 突波實驗 Pulse Test:

為適應電感或電容性電路所產之暫態電流,本品於10倍額定電流的熔斷時間最少為1ms。

In order to stand transient current caused by inductive or capacitive, the fuses are designed to have minimum clearing time of 1 millisecond at 1000% rated current.

7 耐久實驗 Endurance(On-Off Cycle Test):

本實驗乃保證產品之壽命與可靠度,施加60%額定電流之脈波,1分鐘ON,2分鐘OFF,1000次以後,本品不熔斷且內阻變化20%以下。

This test is designed to assure a reliable fuse, Controls are set giving 60% of rated ampere.

1 minute ON, 2 minutes OFF per time, the fuse will not open before 1000 times and the internal resistance change will be below 20%.

8 遮斷能力 Breaking Capacity(Interrupting rating):

0.062A~10A : 50 amperes at 125Vac/dc	12A~15A : 50 amperes at 65V ac/dc
300 amperes at 32Vdc	200 amperes at 86V ac/dc
	300 amperes at 24V dc
	20A~25A : 50 amperes at 65V ac/dc
	300 amperes at 24V dc



9 包裝 Packing:

1000 pcs (7'')/盒，20000 pcs /箱。

內盒印明下列標示:料號、額定(電壓、電流、遮斷能力)及安規名稱。

包裝材料均符合RoHS或者HF的環保要求,且包裝材料不會和零件發生化學反應，造成不良。

1000 pcs (7'') in an inner box. 20000 pcs in an outer box.

The following items indicated on the box.

Mark: Catalog number; ratings (voltage, current, interrupting capacity), and safety mark.

The packing material conforms to RoHS or the HF environmental protection request.

And the packing material can't have the chemical reaction with the components.

10 標記/安規認證 Mark/Agency Approvals:

SEF

印字方式--->

CQ F ** A

**安培數 Ampere Rating : 0.062A-25A

Mark Approvals				Nominal Cold Resistance (Ohms)	Nominal Melting I ² t (A ² sec.)
0.062 A		*		4.6571-8.6489	0.000961
0.08 A		*		3.4818-6.4662	0.001000
0.1 A		*		4.0716-7.5615	0.001500
0.125 A		*		3.5070-6.5130	0.003120
0.2 A		*		1.1874-2.2052	0.008000
0.25 A		*		0.7735-1.4365	0.009380
0.315 A		*		0.5988-1.1120	0.018000
0.375 A		*		0.5124-0.9516	0.021100
0.4 A		*		0.3496-0.6492	0.032000
0.5 A		*		0.3334-0.6192	0.037500
0.75 A		*		0.1698-0.3153	0.153100
1 A	*	*		0.0985-0.1829	0.385000
1.5 A	*	*		0.0791-0.1469	0.725000
2 A	*	*		0.0416-0.0772	0.894000
2.5 A	*	*		0.0269-0.0499	1.182000
3 A	*	*		0.0233-0.0433	1.475000
3.15 A	*	*		0.0207-0.0385	1.655000
3.5 A	*	*		0.0188-0.0348	2.055000
4 A	*	*		0.0146-0.0272	3.882000
5 A	*	*		0.0125-0.0233	5.480000
6 A	*		*	0.0082-0.0152	8.520000
7 A	*		*	0.0073-0.0135	9.931000
8 A	*		*	0.0067-0.0124	18.82000
10 A	*		*	0.0047-0.0087	22.50000
12 A	*		*	0.0029-0.0055	43.20000

Conquer Electronics Co., LTD.

No.26, Wucyuan 5th Rd., Wugu Dist.,(New Taipei Industrial Park) New Taipei City 24888, Taiwan TEL:+886-2-8990-2189 (代表號) FAX:+886-2-8990-2577

Peitou Factory : No. 15, Lane 120, Lite Road, Peitou, 11248, Taipei, Taiwan. TEL: +886-2-2895-8895 (代表號) FAX:+886-2-2895-8880

E-mail: conqfuse@ms62.hinet.net Official Website: http://www.conquer.com.tw

Mark Approvals	PS E JET	UL US	RU US	Nominal Cold Resistance (Ohms)	Nominal Melting I ² t (A ² sec.)
15 A	*		*	0.0020-0.0038	112.5000
20 A			*	0.0018-0.0033	141.5200
25 A			*	0.0013-0.0025	246.5536

*: 有安規認證 With agency approvals

I²t is measured at 10 times of rated current

11 產品描述 Description :

描述 Description	安培數 Ampere Rating
SEF ___A ___V(G)	0.062A~25A

例: SEF A V (G)
 1 2 3 4

- 1 系列品名 Series Model : SEF
- 2 安培數 Ampere Rating : 0.062A~25A
- 3 伏特數 Voltage Rating : 125V / 86V / 65V
- 4 鍍金銅帽 Gold Plated Cap : (G)

貼紙 LABEL

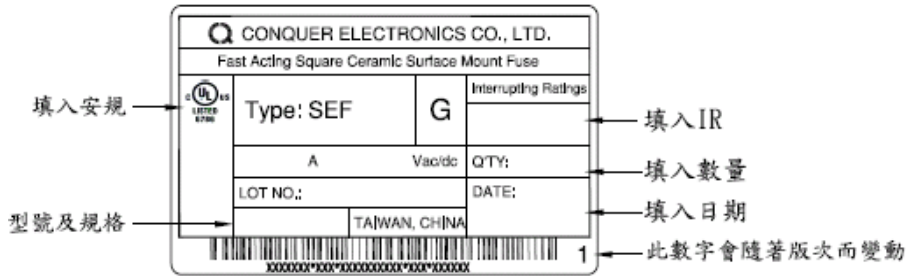

12 建議生產參數:

Recommended Applications Parameters(for lead-free solder alloy):

12.1 Hand Soldering : 350°C, 3sec. max. (Do not touch the terminal cap.)

12.2 Wave Soldering : 260°C, 3sec. max.

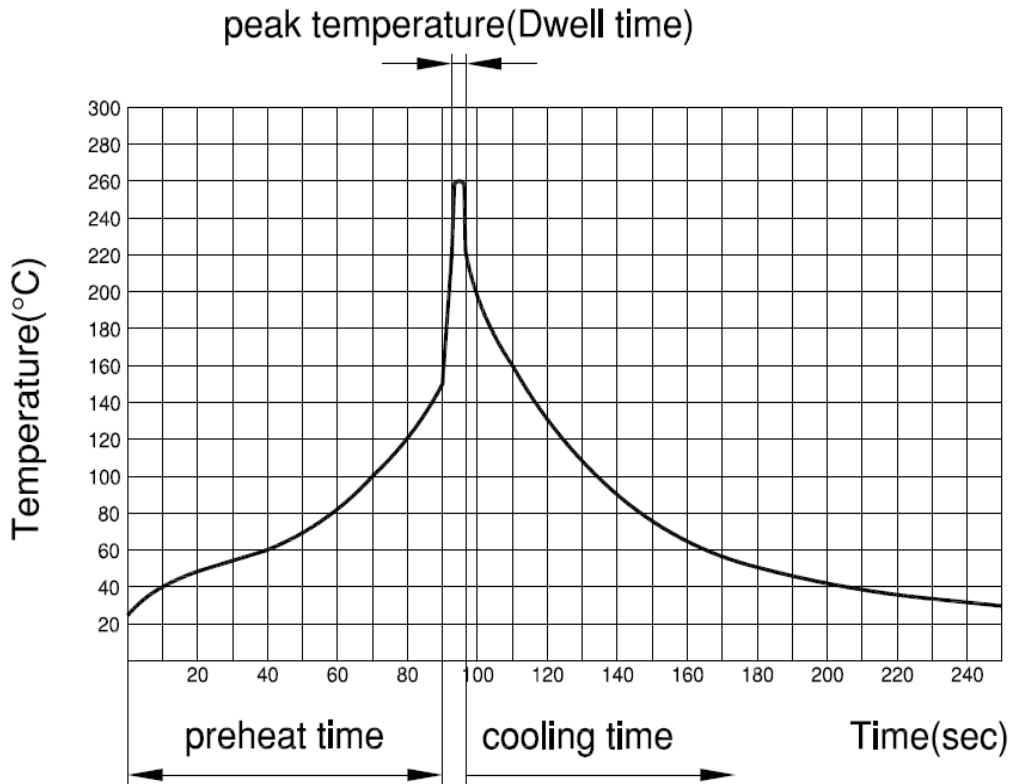

Wave soldering Condition		Lead-free Assembly
Pre-Heat	Temperature Max.	150°C
	Time (Min. to Max.)	60 - 90 sec
Solder Pot Temperature		260°C max.
Solder Dwell Time		2 - 3 sec

12.3 Reflow Soldering : 260°C, 30sec. max. See detail in the soldering profile.

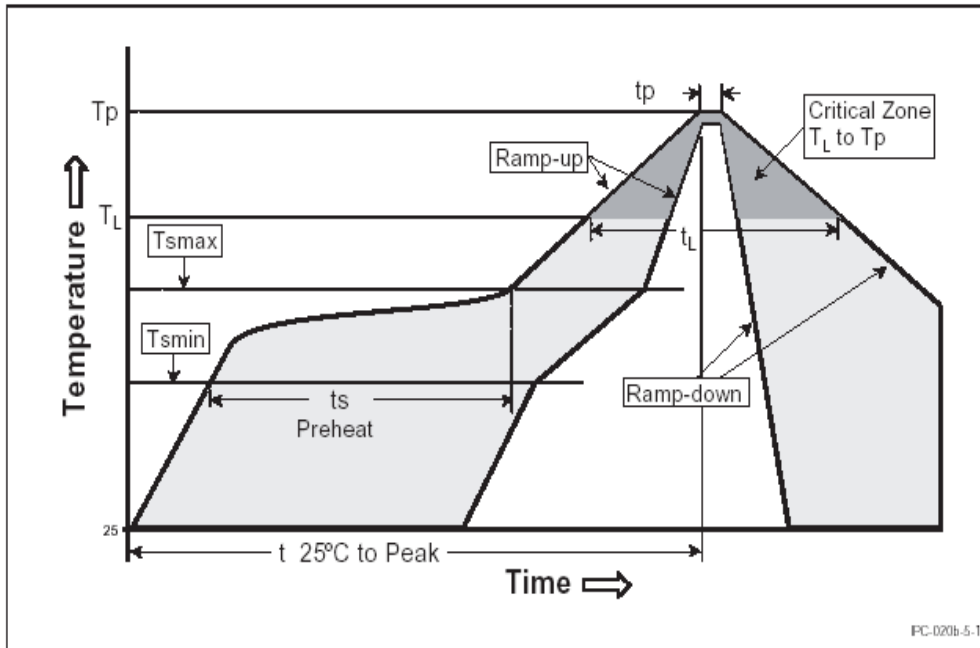

PC-020b-5-1

Reflow Condition		Lead-free Assembly
Pre-Heat	Temperature Min. ($T_{s(min)}$)	150°C
	Temperature Max. ($T_{s(max)}$)	200°C
	Time (Min to Max) (t_s)	60 - 180 sec.
Average Ramp-up Rate (Liquidus Temp (T_L) to peak)		3°C / sec max.
$T_{s(max)}$ to T_L -Ramp-up Rate		5°C / sec max.
Reflow	Temperature (T_L) (Liquidus)	217°C
	Time (t_L)	60 - 150 sec.
Peak Temperature (T_p)		260 +0/-5°C
Time within 5°C of actual peak Temperature (t_p)		10 - 30 sec.
Ramp-down Rate		6°C / sec max.
Time 25°C to peak Temperature ($t_{25°C to peak}$)		8 min max.
Do not exceed		260°C

13 It曲線圖 Time Current Characteristic Curve:

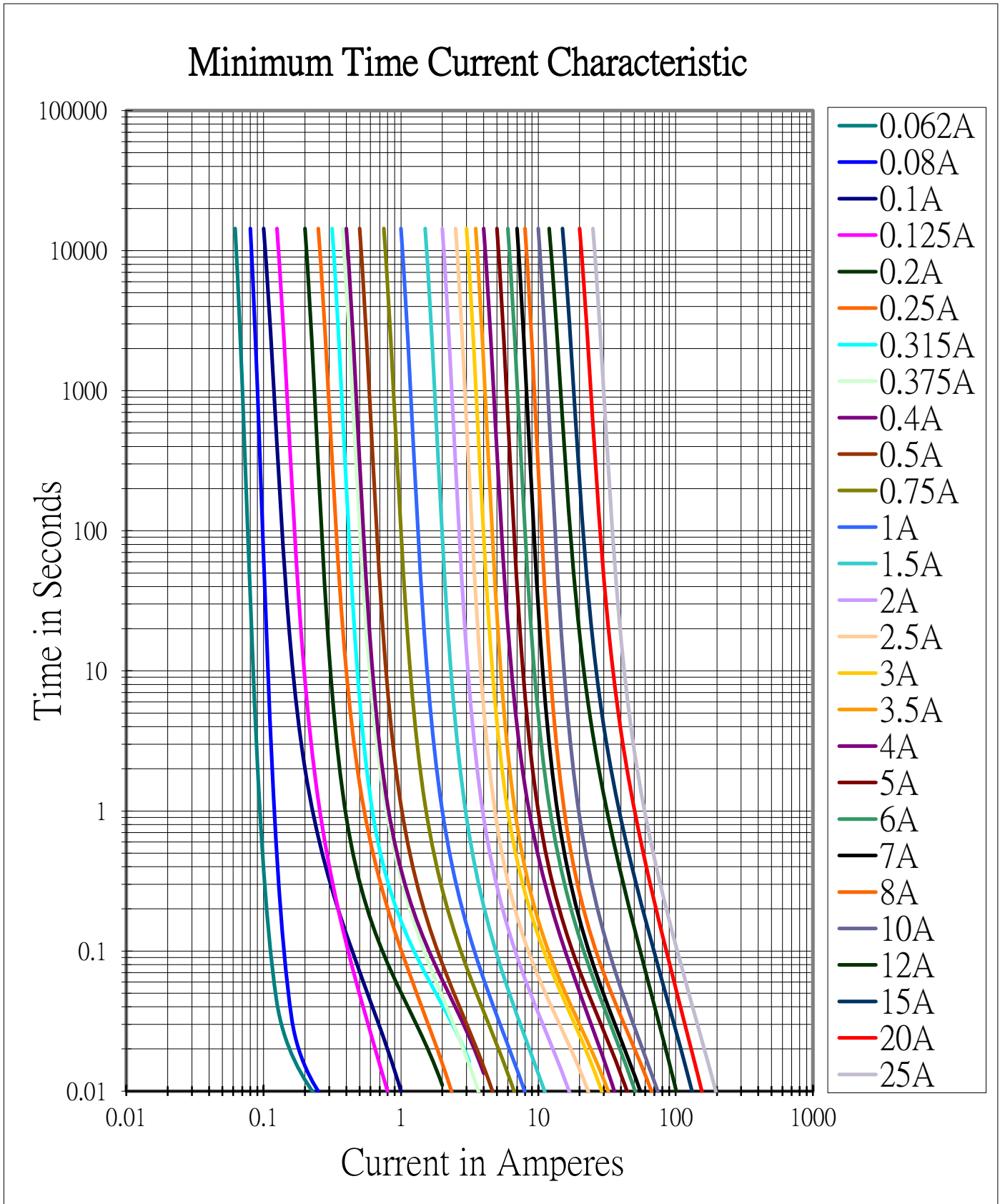

Conquer Electronics Co., LTD.

Wugu Factory : No. 26, Wucyuan 5th Road, Wugu Township, Taipei County 248, Taiwan. TEL:+886-2-8990-2189 (代表號) FAX:+886-2-8990-2577

Peitou Factory : No. 15, Lane 120, Lite Road, Peitou, 11248, Taipei, Taiwan. TEL: +886-2-2895-8895 (代表號) FAX:+886-2-2895-8880

E-mail: conqfuse@ms62.hinet.net Official Website: <http://www.conquer.com.tw>

Average Melting I^2t Curves

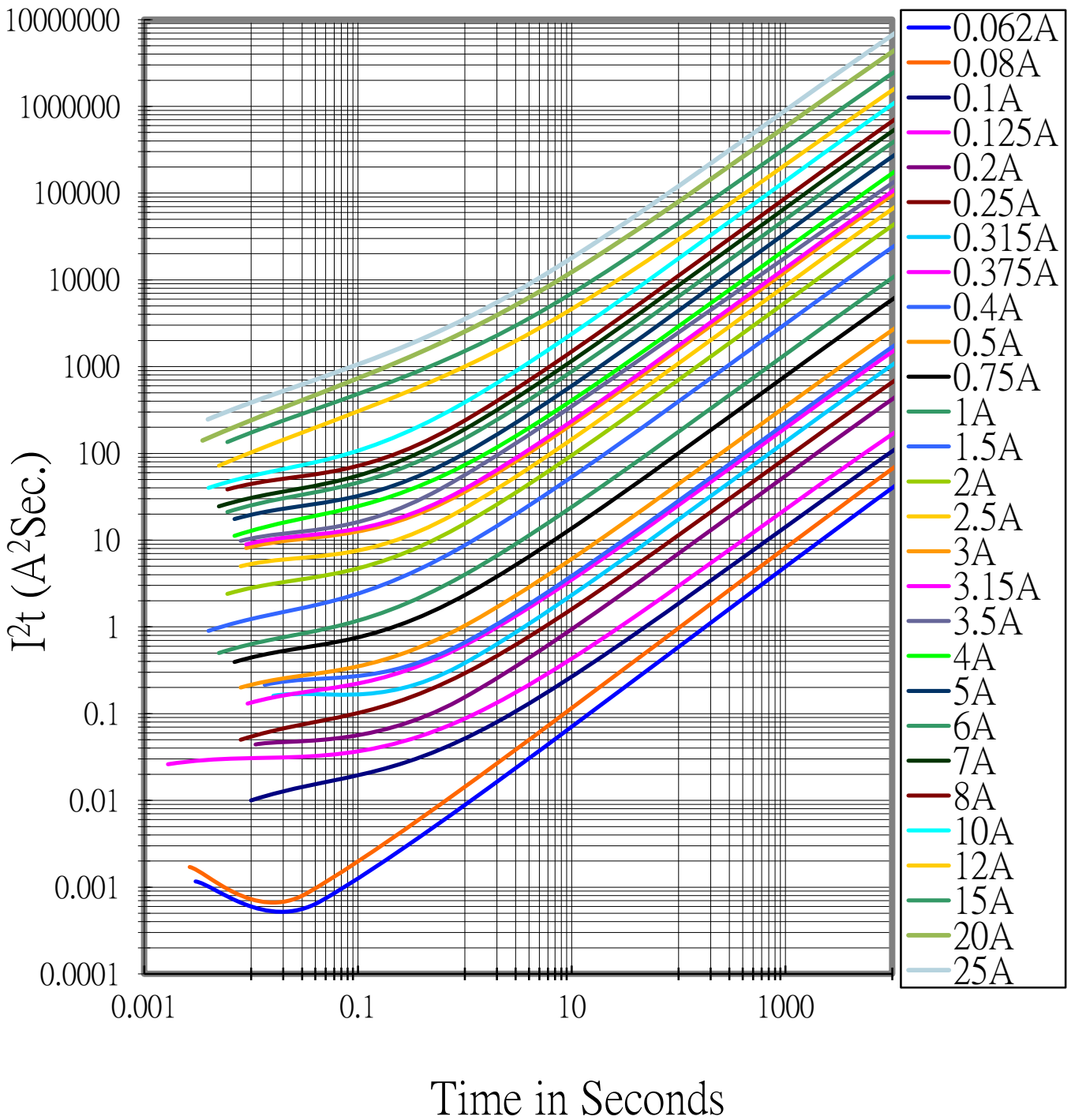

Conquer Electronics Co., LTD.

Wugu Factory : No. 26, Wucyuan 5th Road, Wugu Township, Taipei County 248, Taiwan. TEL:+886-2-8990-2189 (代表號) FAX:+886-2-8990-2577

Peitou Factory : No. 15, Lane 120, Lite Road, Peitou, 11248, Taipei, Taiwan. TEL: +886-2-2895-8895 (代表號) FAX:+886-2-2895-8880

E-mail: conqfuse@ms62.hinet.net Official Website: <http://www.conquer.com.tw>

15 信賴性作業規定 Product Characteristics:

Product Characteristics & Reliability Tests

Test item	Test Description & Reference
Humidity unload test	MIL-STD-202G • Method 103B • Test Condition A Heat (85±0.5°C) & High Humidity (85±1% RH), 240 hours, ΔR<15%
Thermal shock test	MIL-STD-202G, Method 107g • Test Condition B Temperature setup : 25°C ~ -65°C ~ 25°C ~ 125°C Time setup : -65°C(30min)~25°C(5min)~125°C(30min)~ 25°C(5min) 5 cycles, ΔR<15%
Vibration test	MIL-STD-202G • Method 201A Frequency setup : 10 ~ 55 ~ 10 Hz Time setup : 1 Minutes/cycle (X-Y-Z,120 Cycles) 6 hrs, ΔR<15%
Salt spray test	MIL-STD-202G • Method 101E • Test Condition A Salt spray concentration : 5 ± 1% Test liquid temperature : 35 ± 0.5°C 96 hrs, ΔR<15%
Solderability test (for reflow soldering condition)	Reference IEC 60068-2-58 Temperature setup : 235 ± 5°C, 10 ± 1 sec After test terminal electrode wetting area must be greater than 95%
Resistance to solder heat test (for reflow soldering condition)	Reference IEC 60068-2-58 Temperature setup : 235± 5°C, 30± 5 sec ΔR<15%
Bending test	Reference IEC 60127-4 The board shall be bent by 1mm at a rate of 1mm/sec ΔR<15%

Conquer Electronics Co., LTD.

No.26, Wucyuan 5th Rd., Wugu Dist.,(New Taipei Industrial Park) New Taipei City 24888, Taiwan TEL:+886-2-8990-2189 (代表號) FAX:+886-2-8990-2577

Peitou Factory : No. 15, Lane 120, Lite Road, Peitou, 11248, Taipei, Taiwan. TEL: +886-2-2895-8895 (代表號) FAX:+886-2-2895-8880

E-mail: conqfuse@ms62.hinet.net Offical Website: <http://www.conquer.com.tw>



16 其他 Other:

- 16.1 除非另有指定，上述機械、電器特性，係於常溫，標準狀況下測試之。
Unless otherwise specified, all tests to be performed at $25\pm 5^{\circ}\text{C}$ and 35-75% RH.
- 16.2 於標準狀況下儲放一年，本品乃確保上述機械與電氣之特性。
After one year's storage under normal condition, this item is guaranteed to meet the requirements mentioned above.
- 16.3 使用於此產品之材料中，使用高溫熔化型之焊錫，此焊錫成份中鉛含量大於85%，故此產品符合RoHS指令要求之焊錫含鉛量超過85%之排除條款規範。
Because the materials used in these fuses include high melting temperature type solder and this solder contains more than 85% lead (Pb), so these products can conform to the exemptions of the requirements of RoHS Directive .
- 16.4 工作溫度： -55°C to $+125^{\circ}\text{C}$
Operating Temperature : -55°C to $+125^{\circ}\text{C}$

Conquer Electronics Co., LTD.

Wugu Factory : No. 26, Wucyuan 5th Road, Wugu Township, Taipei County 248, Taiwan. TEL:+886-2-8990-2189 (代表號) FAX:+886-2-8990-2577

Peitou Factory : No. 15, Lane 120, Lite Road, Peitou, 11248, Taipei, Taiwan. TEL: +886-2-2895-8895 (代表號) FAX:+886-2-2895-8880

E-mail: conqfuse@ms62.hinet.net Official Website: <http://www.conquer.com.tw>