

Description

The AO4407 uses advanced trench technology to provide excellent $R_{DS(ON)}$, low gate charge and operation with gate voltages as low as 4.5V.

General Features

- $V_{DS} = -30V$
 $R_{DS(ON)} < 20m\Omega @ V_{GS} = -4.5V \quad I_D = -6.0A$
 $R_{DS(ON)} < 14m\Omega @ V_{GS} = -10V \quad I_D = -10.0A$
- High power and current handling capability
- Lead free product is acquired
- Surface mount package

Application

- Battery Switch
- Load switch
- Power management

SOP-8

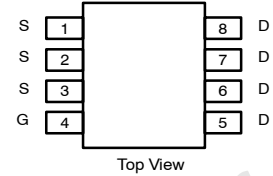

Equivalent Circuit

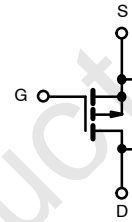

MARKING

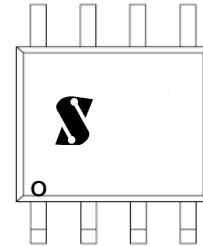

Y : year code W : week code

Absolute Maximum Ratings ($T_A = 25^\circ C$ unless otherwise noted)

| Parameter | Symbol | Limit | Unit |
|--|--------------------|------------|------------|
| Drain-Source Voltage | V_{DS} | -30 | V |
| Gate-Source Voltage | V_{GS} | ± 20 | V |
| Continuous Drain Current ($T_J = 150^\circ C$) | I_D | -10 | A |
| | $T_A = 25^\circ C$ | | |
| Drain Current-Pulsed ^(Note 1) | I_{DM} | -60 | A |
| Maximum Power Dissipation | P_D | 2.1 | W |
| Operating Junction and Storage Temperature Range | T_J, T_{STG} | -55 To 150 | $^\circ C$ |

Thermal Characteristic

| | | | |
|---|-----------------|----|--------------|
| Thermal Resistance, Junction-to-Ambient ^(Note 2) | $R_{\theta JA}$ | 50 | $^\circ C/W$ |
|---|-----------------|----|--------------|

Electrical Characteristics ($T_A=25^\circ\text{C}$ unless otherwise noted)

| Parameter | Symbol | Condition | Min | Typ | Max | Unit |
|---|--------------|--|-----|------|-----------|------------|
| Off Characteristics | | | | | | |
| Drain-Source Breakdown Voltage | BV_{DSS} | $V_{GS}=0V, I_D=-250\mu A$ | -30 | - | - | V |
| Zero Gate Voltage Drain Current | I_{DSS} | $V_{DS}=-30V, V_{GS}=0V$ | - | - | -1 | μA |
| Gate-Body Leakage Current | I_{GSS} | $V_{GS}=\pm 20V, V_{DS}=0V$ | - | - | ± 100 | nA |
| On Characteristics (Note 3) | | | | | | |
| Gate Threshold Voltage | $V_{GS(th)}$ | $V_{DS}=V_{GS}, I_D=-250\mu A$ | -1 | - | -3.0 | V |
| Drain-Source On-State Resistance | $R_{DS(on)}$ | $V_{GS}=-10V, I_D=-10.0A$ | - | 9 | 14 | m Ω |
| | | $V_{GS}=-4.5V, I_D=-6.0A$ | - | 14 | 20 | m Ω |
| Forward Transconductance | g_{FS} | $V_{DS}=-15V, I_D=-5.0A$ | 20 | - | - | S |
| Dynamic Characteristics (Note 4) | | | | | | |
| Input Capacitance | C_{iss} | $V_{DS}=-15V, V_{GS}=0V,$ $F=1.0MHz$ | - | 1750 | - | PF |
| Output Capacitance | C_{oss} | | - | 215 | - | PF |
| Reverse Transfer Capacitance | C_{rss} | | - | 180 | - | PF |
| Switching Characteristics (Note 4) | | | | | | |
| Turn-on Delay Time | $t_{d(on)}$ | $V_{DD}=-15V, I_D=-10A,$ $V_{GS}=-10V, R_{GEN}=1\Omega$ | - | 9 | - | nS |
| Turn-on Rise Time | t_r | | - | 8 | - | nS |
| Turn-Off Delay Time | $t_{d(off)}$ | | - | 28 | - | nS |
| Turn-Off Fall Time | t_f | | - | 10 | - | nS |
| Total Gate Charge | Q_g | $V_{DS}=-15V, I_D=-10.0A$ $V_{GS}=-10V$ | - | 24 | - | nC |
| Gate-Source Charge | Q_{gs} | | - | 3.5 | - | nC |
| Gate-Drain Charge | Q_{gd} | | - | 6 | - | nC |
| Drain-Source Diode Characteristics | | | | | | |
| Diode Forward Voltage | V_{SD} | $V_{GS}=0V, I_S=-10A$ | - | - | -1.2 | V |

Notes:

1. Repetitive Rating: Pulse width limited by maximum junction temperature.
2. Surface Mounted on FR4 Board, $t \leq 10$ sec.
3. Pulse Test: Pulse Width $\leq 300\mu s$, Duty Cycle $\leq 2\%$.
4. Guaranteed by design, not subject to production

Typical Electrical and Thermal Characteristics

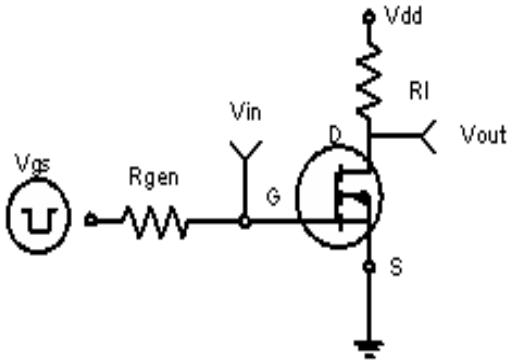

Figure 1: Switching Test Circuit

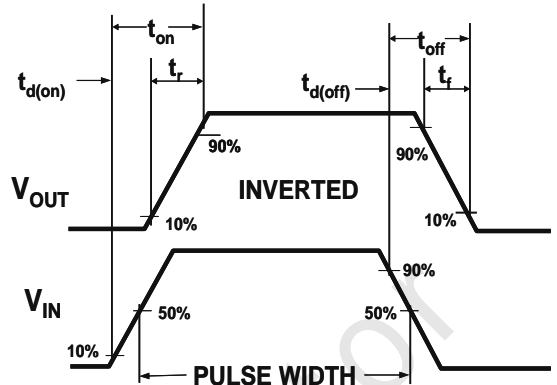

Figure 2: Switching Waveforms

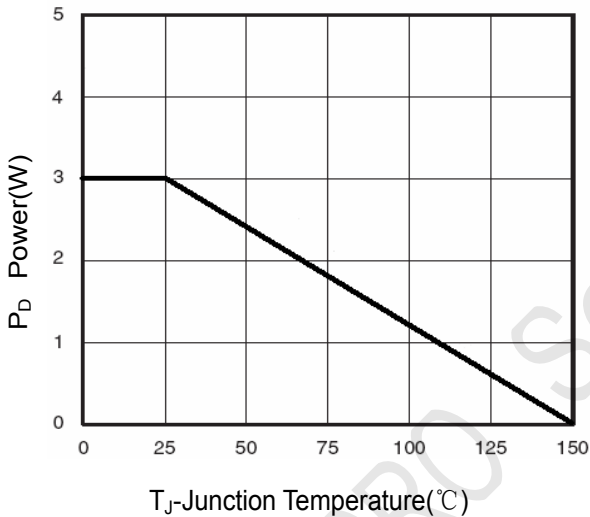

Figure 3 Power Dissipation

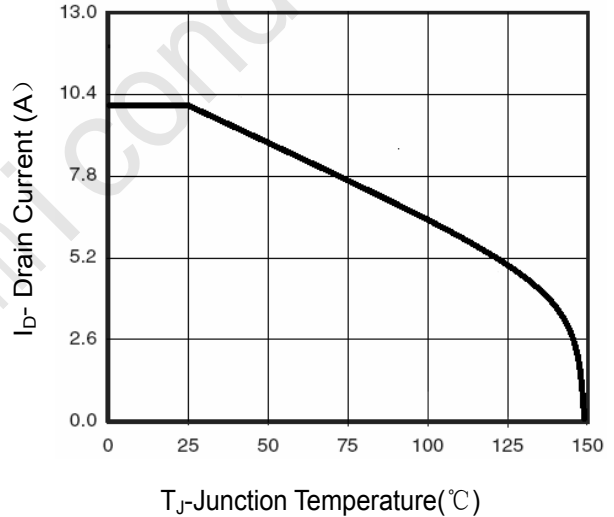

Figure 4 Drain Current

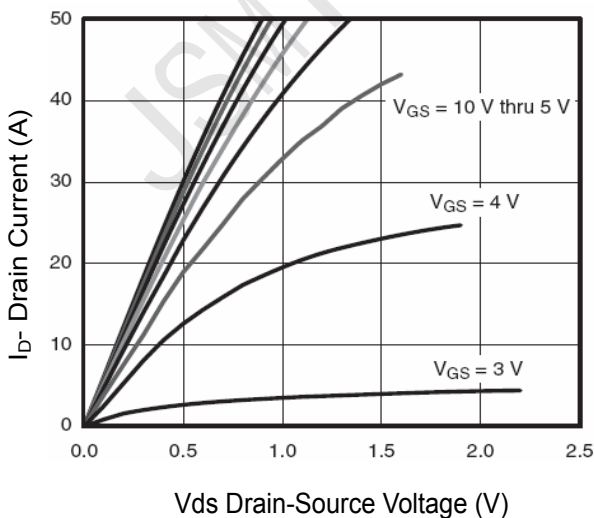

Figure 5 Output Characteristics

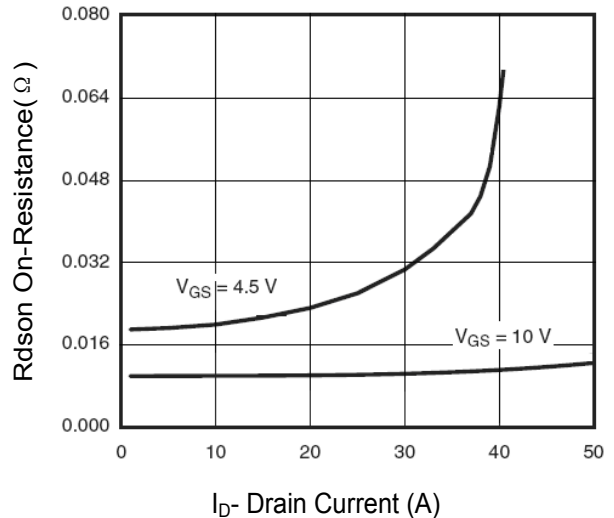

Figure 6 Drain-Source On-Resistance

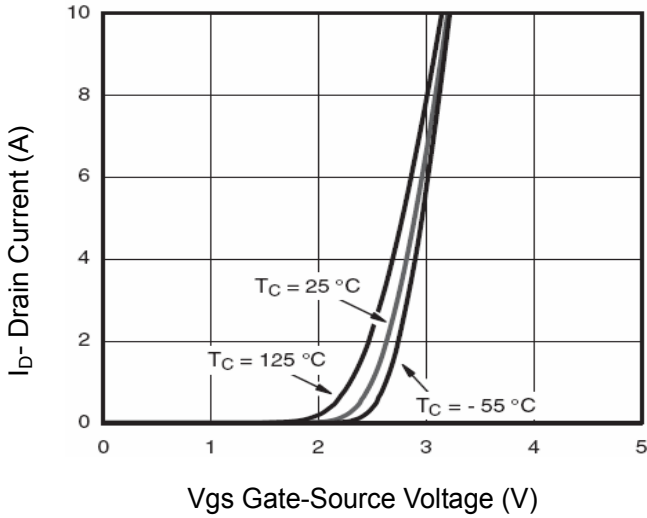

Figure 7 Transfer Characteristics

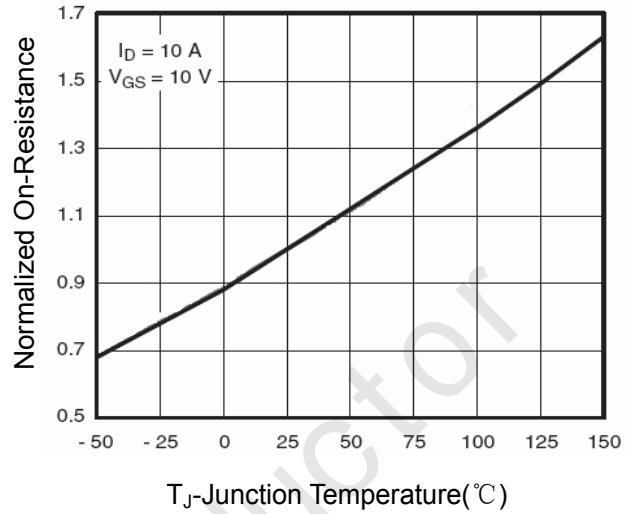

Figure 8 Drain-Source On-Resistance

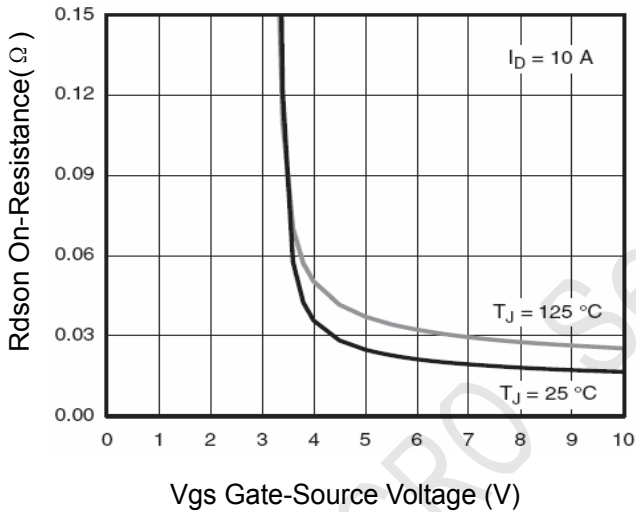

Figure 9 Rdson vs Vgs

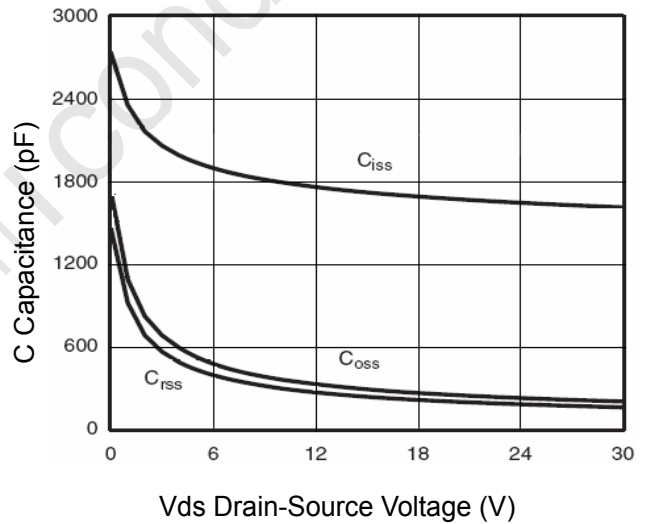

Figure 10 Capacitance vs Vds

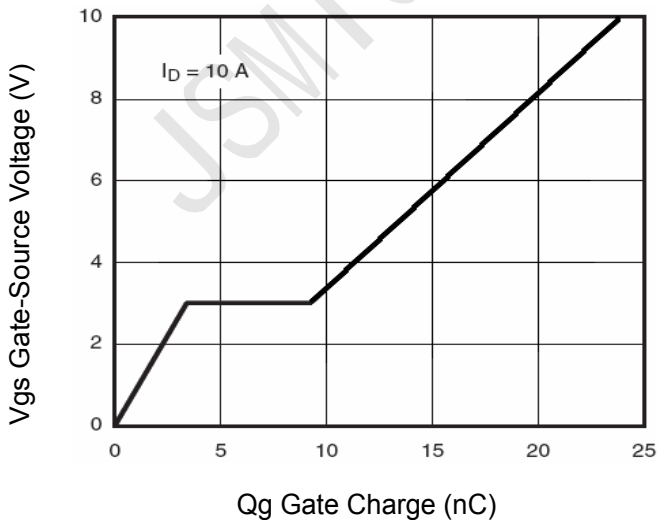

Figure 11 Gate Charge

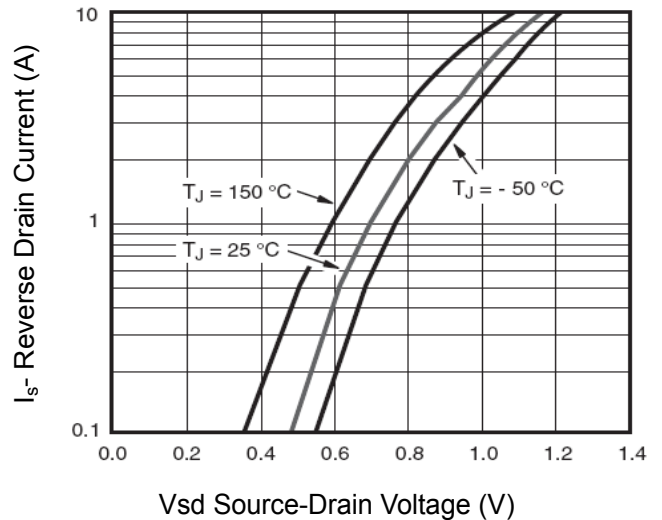

Figure 12 Source- Drain Diode Forward

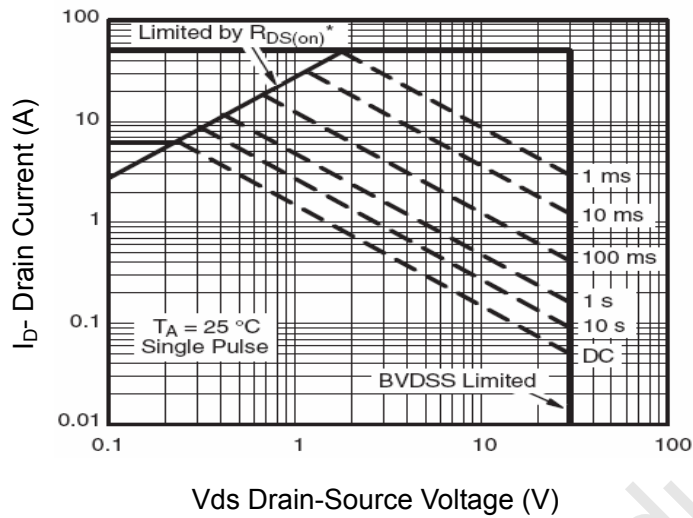

Figure 13 Safe Operation Area

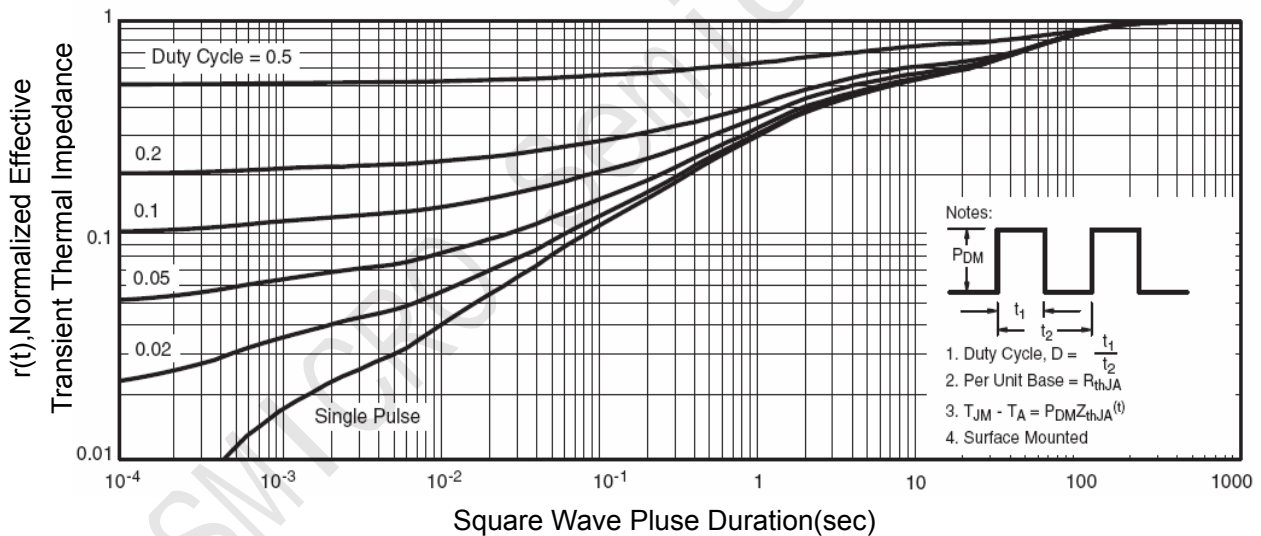
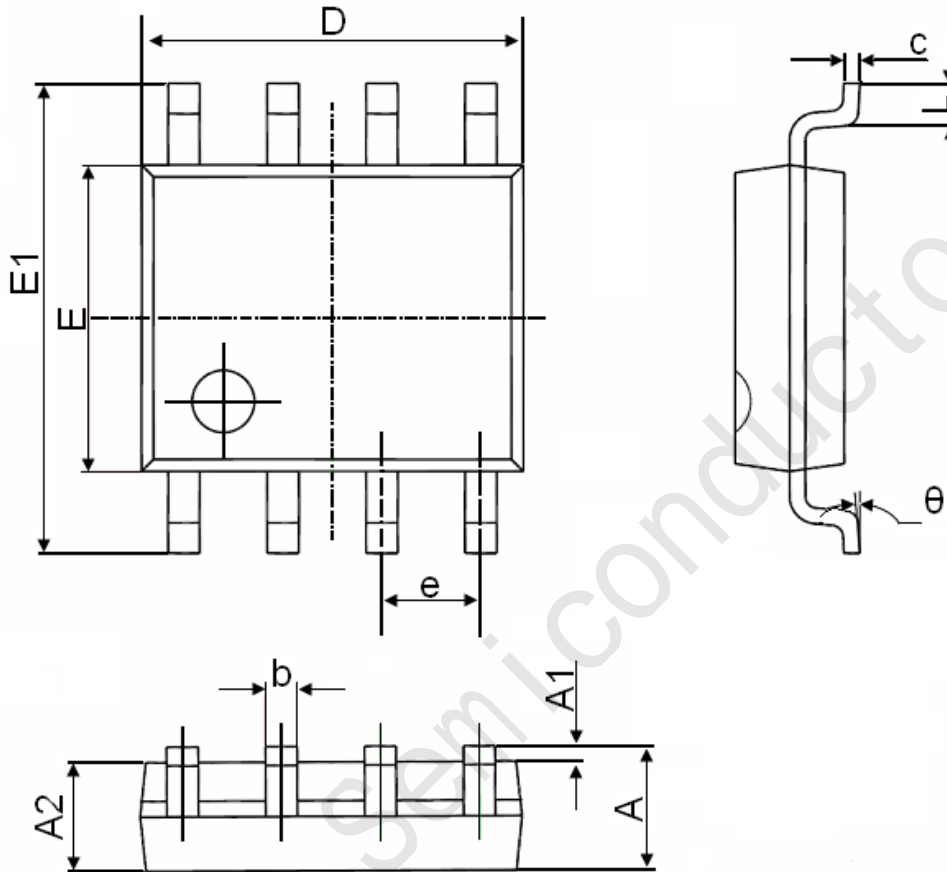

Figure 14 Normalized Maximum Transient Thermal Impedance

SOP-8 Package Information

| Symbol | Dimensions In Millimeters | | Dimensions In Inches | |
|--------|---------------------------|-------|----------------------|-------|
| | Min. | Max. | Min. | Max. |
| A | 1.350 | 1.750 | 0.053 | 0.069 |
| A1 | 0.100 | 0.250 | 0.004 | 0.010 |
| A2 | 1.350 | 1.550 | 0.053 | 0.061 |
| b | 0.330 | 0.510 | 0.013 | 0.020 |
| c | 0.170 | 0.250 | 0.006 | 0.010 |
| D | 4.700 | 5.100 | 0.185 | 0.200 |
| E | 3.800 | 4.000 | 0.150 | 0.157 |
| E1 | 5.800 | 6.200 | 0.228 | 0.244 |
| e | 1.270(BSC) | | 0.050(BSC) | |
| L | 0.400 | 1.270 | 0.016 | 0.050 |
| θ | 0° | 8° | 0° | 8° |