

GENERAL DESCRIPTION

The SGM2202 is a high voltage and high PSRR linear regulator. It is capable of supplying 150mA output current. The operating input voltage is up to 36V. The output voltage range is from 2.5V to 5.0V in fixed output version. For adjustable output version, the output voltage can be adjusted from 0.8V to 13.2V by using external resistors.

Other features include logic-controlled shutdown mode, current limit and thermal shutdown protection.

The SGM2202 is available in Green SOT-23-5 and SOT-23-6 packages. It operates over an operating temperature range of -40°C to +85°C.

FEATURES

- **High Input Voltage: Up to 36V**
- **Fixed Output Voltages: 2.5V, 2.8V, 3.0V, 3.3V, 5.0V**
- **Adjustable Output Voltages: 0.8V to 13.2V**
- **150mA Guaranteed Output Current**
- **Output Voltage Accuracy: ±2.5% at +25°C**
- **High PSRR: 40dB (TYP) at 1kHz**
- **Low Dropout Voltage**
- **Low Power Consumption: 4.2µA (TYP)**
- **Shutdown Supply Current: 1.5µA (TYP)**
- **Low Temperature Coefficient**
- **Thermal Shutdown Protection**
- **Output Current Limit**
- **-40°C to +85°C Operating Temperature Range**
- **Available in Green SOT-23-5 and SOT-23-6 Packages**

APPLICATIONS

- Palmtops
- High-Power Boost Applications
- Power Source for Battery-Powered Equipment
- Home Electric/Electronic Appliances

TYPICAL APPLICATION

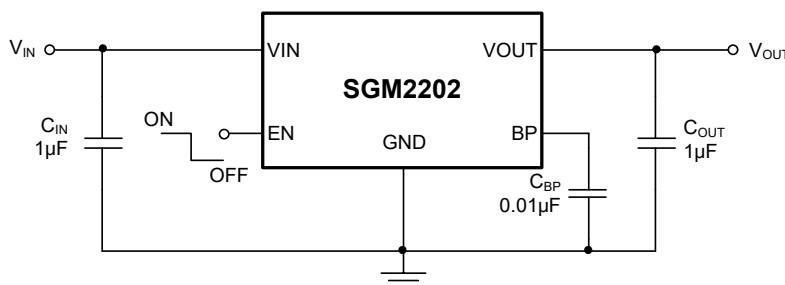

Figure 1. Fixed Voltage Typical Application Circuit

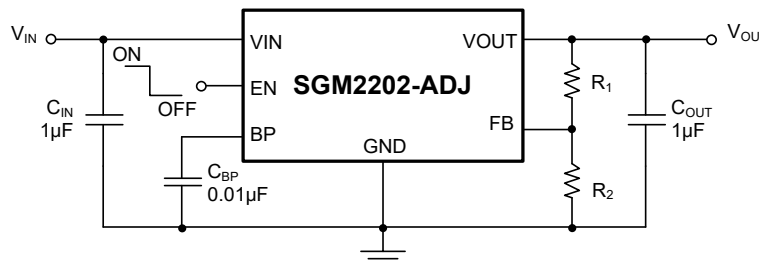

Figure 2. Adjustable Voltage Typical Application Circuit

PACKAGE/ORDERING INFORMATION

MODEL	V _{OUT} (V)	PACKAGE DESCRIPTION	SPECIFIED TEMPERATURE RANGE	ORDERING NUMBER	PACKAGE MARKING	PACKING OPTION
SGM2202-2.5	2.5	SOT-23-5	-40°C to +85°C	SGM2202-2.5YN5G/TR	G1DXX	Tape and Reel, 3000
SGM2202-2.8	2.8	SOT-23-5	-40°C to +85°C	SGM2202-2.8YN5G/TR	SX5XX	Tape and Reel, 3000
SGM2202-3.0	3.0	SOT-23-5	-40°C to +85°C	SGM2202-3.0YN5G/TR	SX6XX	Tape and Reel, 3000
		SOT-23-5 (L-Type)	-40°C to +85°C	SGM2202-3.0YN5LG/TR	G12XX	Tape and Reel, 3000
SGM2202-3.3	3.3	SOT-23-5	-40°C to +85°C	SGM2202-3.3YN5G/TR	SX8XX	Tape and Reel, 3000
SGM2202-5.0	5.0	SOT-23-5	-40°C to +85°C	SGM2202-5.0YN5G/TR	G3DXX	Tape and Reel, 3000
SGM2202-ADJ	Adjustable	SOT-23-6	-40°C to +85°C	SGM2202-ADJYN6G/TR	SVFXX	Tape and Reel, 3000

MARKING INFORMATION

NOTE: XX = Date Code.

YYY X X

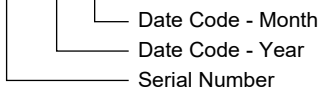

Green (RoHS & HSF): SG Micro Corp defines "Green" to mean Pb-Free (RoHS compatible) and free of halogen substances. If you have additional comments or questions, please contact your SGMICRO representative directly.

ABSOLUTE MAXIMUM RATINGS

- VIN, EN to GND -0.3V to 44V
- VOU_T to GND -0.3V to Min(V_{IN} + 0.3V, 15V)
- BP, FB to GND -0.3V to Min(V_{IN} + 0.3V, 6V)
- Power Dissipation, P_D @ T_A = +25°C
- SOT-23-5, SOT-23-5 (L-Type).....0.517W
- SOT-23-60.558W
- Package Thermal Resistance
- SOT-23-5, SOT-23-5 (L-Type), θ_{JA} 242°C/W
- SOT-23-6, θ_{JA} 224°C/W
- Junction Temperature+150°C
- Storage Temperature Range -65°C to +150°C
- Lead Temperature (Soldering, 10s)+260°C
- ESD Susceptibility
- HBM 4000V
- MM 150V
- CDM 1000V

RECOMMENDED OPERATING CONDITIONS

- Input Voltage Range2.7V to 36V
- Operating Temperature Range -40°C to +85°C

OVERSTRESS CAUTION

Stresses beyond those listed in Absolute Maximum Ratings may cause permanent damage to the device. Exposure to absolute maximum rating conditions for extended periods may affect reliability. Functional operation of the device at any conditions beyond those indicated in the Recommended Operating Conditions section is not implied.

ESD SENSITIVITY CAUTION

This integrated circuit can be damaged if ESD protections are not considered carefully. SGMICRO recommends that all integrated circuits be handled with appropriate precautions. Failure to observe proper handling and installation procedures can cause damage. ESD damage can range from subtle performance degradation to complete device failure. Precision integrated circuits may be more susceptible to damage because even small parametric changes could cause the device not to meet the published specifications.

DISCLAIMER

SG Micro Corp reserves the right to make any change in circuit design, or specifications without prior notice.

PIN CONFIGURATIONS

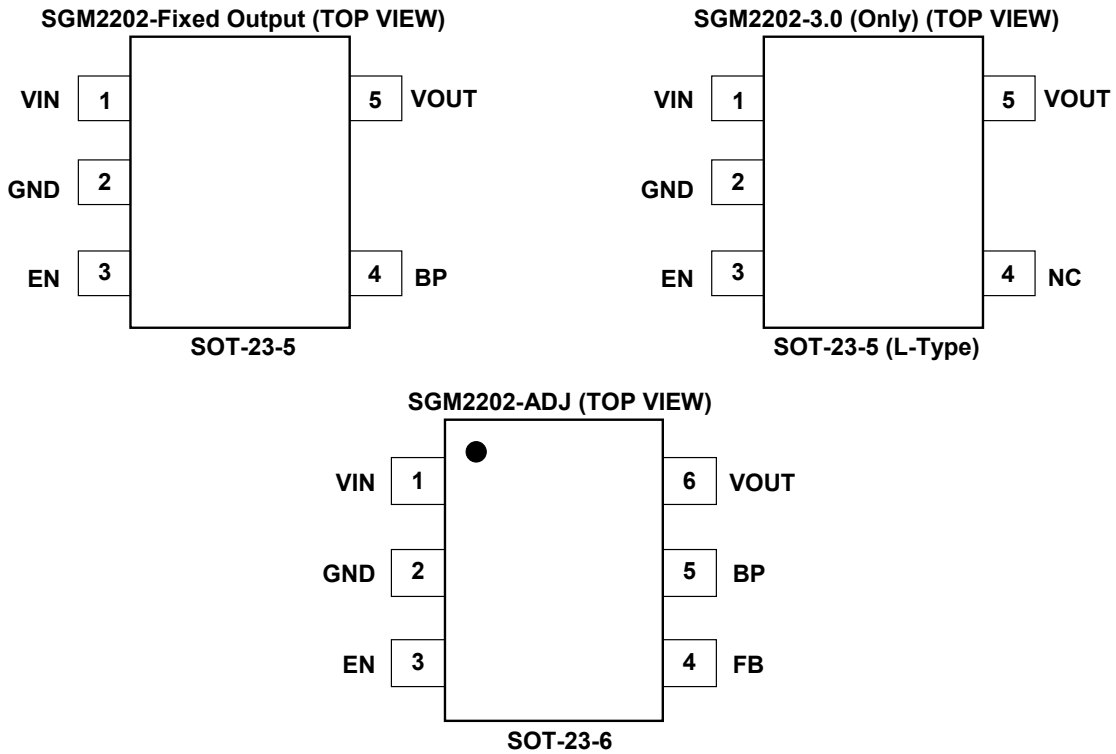

PIN DESCRIPTION

PIN			NAME	FUNCTION
SOT-23-5	SOT-23-5 (L-Type)	SOT-23-6		
1	1	1	VIN	Input Supply Voltage Pin. It is recommended to use a 1μF or larger ceramic capacitor from VIN pin to ground. This ceramic capacitor should be placed as close as possible to IN pin.
2	2	2	GND	Ground.
3	3	3	EN	Enable Pin. Drive EN high to turn on the regulator. Drive EN low to turn off the regulator. This pin must be connected to VIN pin if enable functionality is not used.
-	-	4	FB	Feedback Voltage Input Pin. Connect this pin to the midpoint of an external resistor divider to adjust the output voltage. Place the resistors as close as possible to this pin.
4	-	5	BP	Reference-Noise Bypass Pin. Bypass with an external capacitor C _{BP} can reduce output noise to very low level. The capacitor is recommended to be placed very close to the pin for high PSRR.
-	4	-	NC	Not Connected.
5	5	6	VOUT	Regulator Output Pin. It is recommended to use an output capacitor with effective capacitance in the range of 1μF to 10μF. The capacitor should be located very close to this pin.

ELECTRICAL CHARACTERISTICS

($V_{IN} = 15V$, $V_{EN} = 2V$, $C_{IN} = C_{OUT} = 1\mu F$, $C_{BP} = 0.01\mu F$, Full = $-40^{\circ}C$ to $+85^{\circ}C$, typical values are at $T_A = +25^{\circ}C$, unless otherwise noted.)

PARAMETER	SYMBOL	CONDITIONS	TEMP	MIN	TYP	MAX	UNITS
Input Voltage Range	V_{IN}	$V_{OUT} < 3.3V$	Full	2.7		32	V
		$V_{OUT} \geq 3.3V$	Full	2.7		36	
Output Voltage Accuracy		$I_{OUT} = 1mA$	$+25^{\circ}C$	-2.5		2.5	%
Feedback Voltage	V_{FB}	SGM2202-ADJ, $V_{FB} = V_{OUT}$, $I_{OUT} = 1mA$	$+25^{\circ}C$		0.8		V
FB Input Current	I_{FB}	SGM2202-ADJ, $V_{FB} = 0.9V$	Full	-15		15	nA
Ground Pin Current		No load	$+25^{\circ}C$		4.2	5.4	μA
			Full			6.5	
		$I_{OUT} = 50mA$	$+25^{\circ}C$		4.2		
Maximum Output Current		$V_{IN} = V_{OUT} + 2V$ or $4V$, whichever is greater	$+25^{\circ}C$	150			mA
Dropout Voltage ⁽¹⁾	V_{DROP}	$I_{OUT} = 150mA$, $V_{OUT} \geq 2.5V$	$+25^{\circ}C$		1300	1840	mV
			Full			2380	
Line Regulation	$\frac{\Delta V_{OUT}}{\Delta V_{IN} \times V_{OUT}}$	$V_{IN} = V_{OUT} + 2V$ or $4V$ to $32V$, $I_{OUT} = 1mA$, $V_{OUT} < 3.3V$	$+25^{\circ}C$		0.005	0.01	%V
		$V_{IN} = V_{OUT} + 2V$ to $36V$, $I_{OUT} = 1mA$, $V_{OUT} \geq 3.3V$	$+25^{\circ}C$		0.005	0.01	
Load Regulation	ΔV_{OUT}	$V_{IN} = V_{OUT} + 2V$ or $4V$, $I_{OUT} = 1mA$ to $150mA$	$+25^{\circ}C$		10	24	mV
Power Supply Rejection Ratio	PSRR	$V_{OUT} = 3.3V$, $I_{OUT} = 10mA$	$f = 217Hz$	$+25^{\circ}C$		55	dB
			$f = 1kHz$	$+25^{\circ}C$		40	
Output Voltage Temperature Coefficient ⁽²⁾	$\frac{\Delta V_{OUT}}{\Delta T_A \times V_{OUT}}$	$V_{IN} = V_{OUT} + 2V$ or $4V$, $I_{OUT} = 1mA$	Full		35		ppm/ $^{\circ}C$
Shutdown							
EN Input Threshold	V_{IH}	$V_{IN} = 2.7V$ to $36V$	Full	1.2			V
	V_{IL}		Full			0.4	
EN Input Bias Current	I_{BH}	$V_{EN} = V_{IN}$	Full		0.02	1	μA
	I_{BL}	$V_{EN} = 0V$	Full	-1		1	
Shutdown Supply Current	$I_{Q(SHDN)}$	$V_{EN} = 0V$	$+25^{\circ}C$		1.5	2	μA
Start-Up Time ⁽³⁾	t_{STR}	No load	$+25^{\circ}C$		5		ms
R_{ON} of Discharge MOSFET		$V_{IN} = 2.7V$, $V_{EN} = 0V$, $I_{OUT} = -1mA$	$+25^{\circ}C$		75		Ω
Thermal Protection							
Thermal Shutdown Temperature	T_{SHDN}				150		$^{\circ}C$
Thermal Shutdown Hysteresis	ΔT_{SHDN}				20		$^{\circ}C$

NOTES:

1. The dropout voltage is defined as the difference between V_{IN} and V_{OUT} when V_{OUT} falls to $95\% \times V_{OUT}$ for $V_{IN} = V_{OUT} + 2V$.
2. Output voltage temperature coefficient is defined as the worst-case voltage change divided by the total temperature range.
3. Time needed for V_{OUT} to reach 90% of final value.

TYPICAL PERFORMANCE CHARACTERISTICS

$T_A = +25^\circ\text{C}$, $V_{IN} = 5.3\text{V}$, $V_{EN} = 2\text{V}$, $V_{OUT} = 3.3\text{V}$, $C_{IN} = C_{OUT} = 1\mu\text{F}$, $C_{BP} = 0.01\mu\text{F}$, unless otherwise noted.

Load-Transient Response

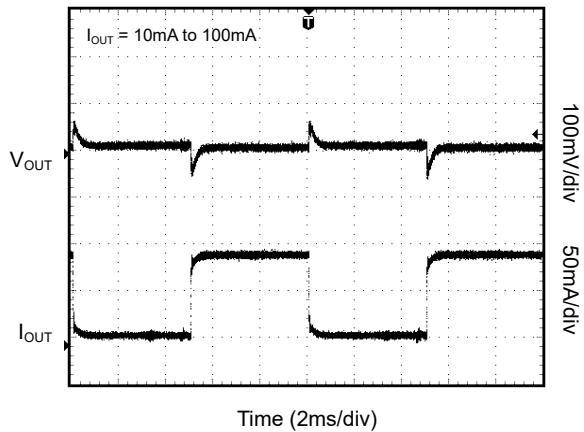

Line-Transient Response

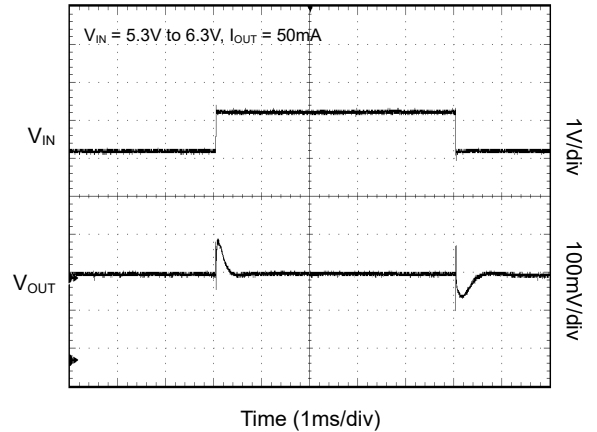

Power-Up/Power-Down Output Waveform

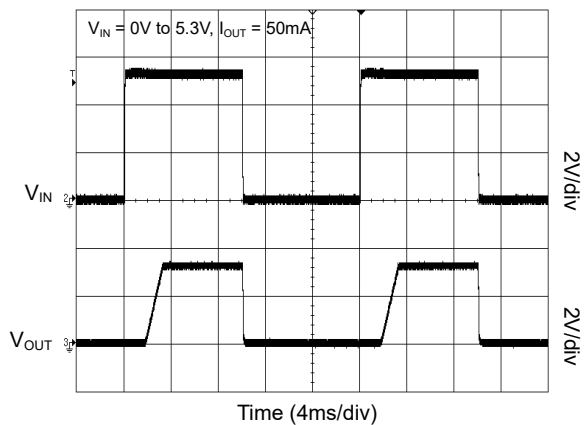

Power Ramp-Up/Ramp-Down Output Waveform

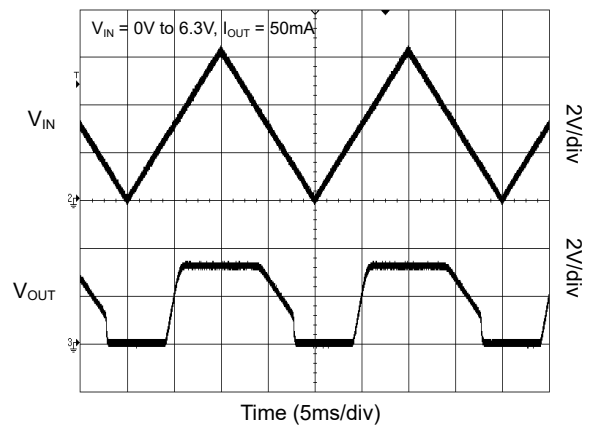

Output Short Waveform

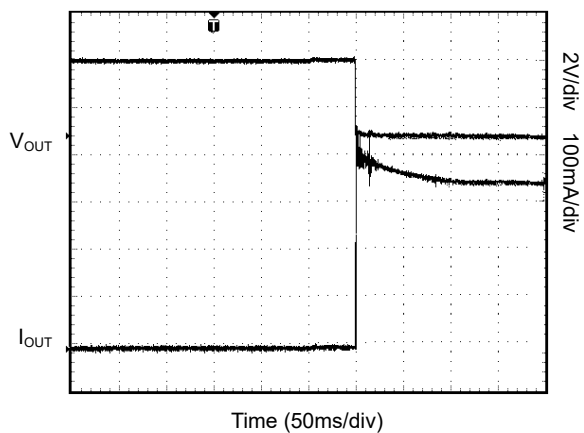

Thermal Protection Waveform

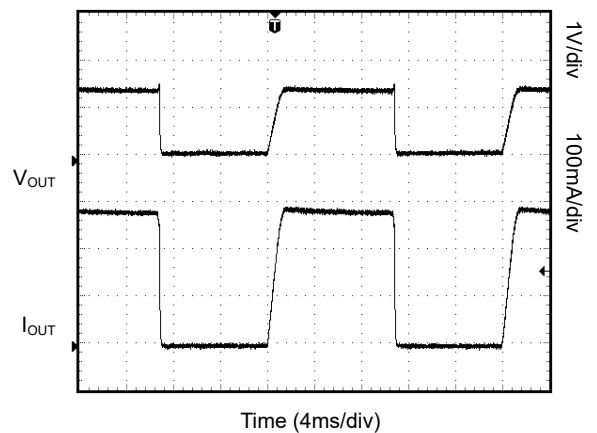

TYPICAL PERFORMANCE CHARACTERISTICS (continued)

$T_A = +25^\circ\text{C}$, $V_{IN} = 5.3\text{V}$, $V_{EN} = 2\text{V}$, $V_{OUT} = 3.3\text{V}$, $C_{IN} = C_{OUT} = 1\mu\text{F}$, $C_{BP} = 0.01\mu\text{F}$, unless otherwise noted.

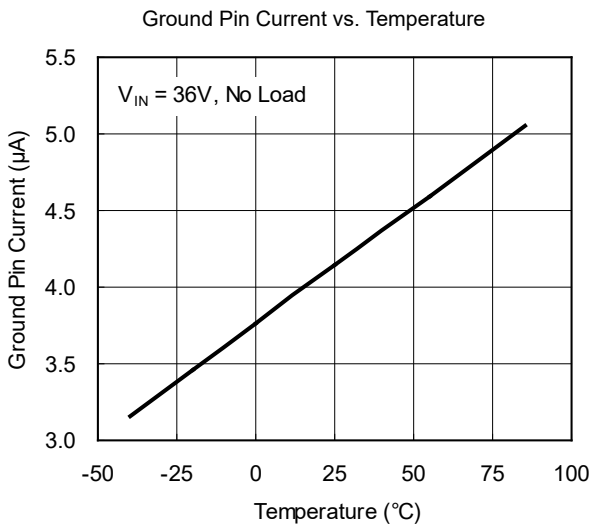
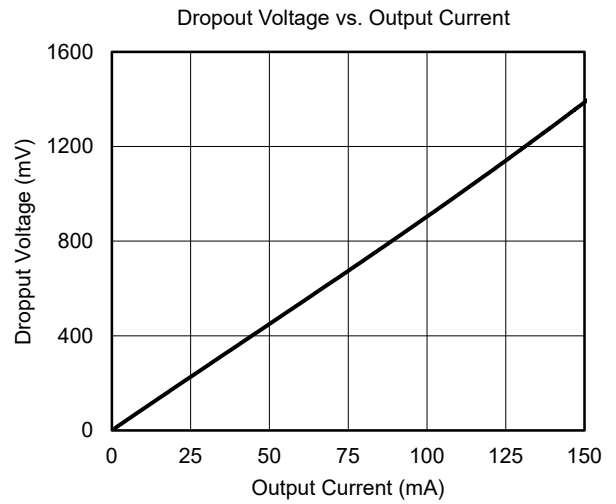
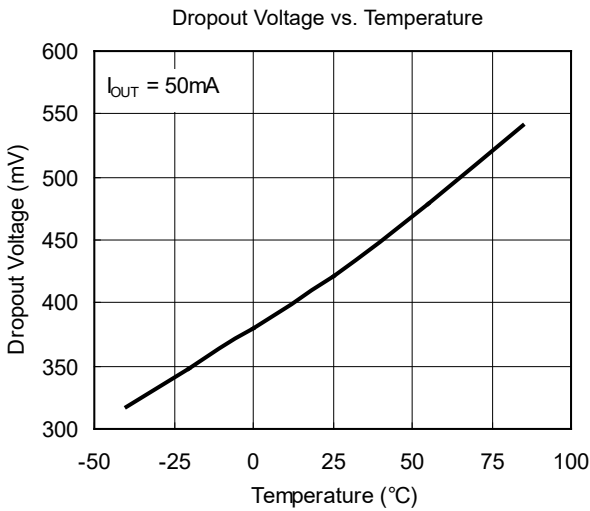
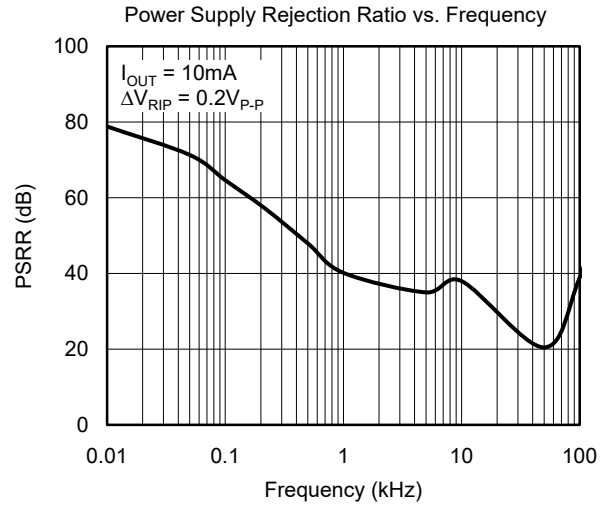
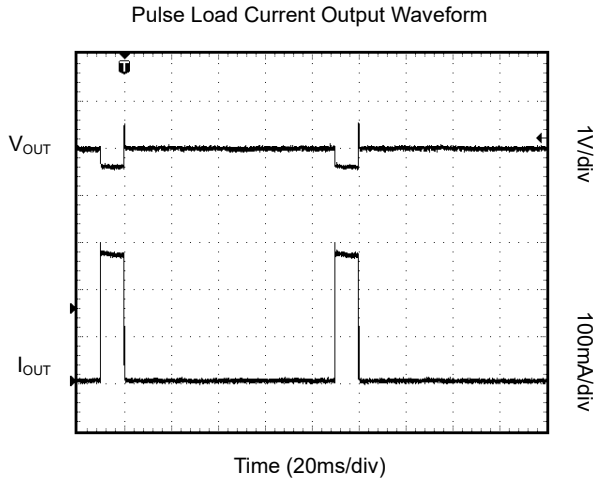

APPLICATION INFORMATION

Input Capacitor Selection (C_{IN})

The input decoupling capacitor is necessary to be connected as close as possible to the VIN pin for ensuring the device stability. 1µF or larger X7R or X5R ceramic capacitor is selected to get good dynamic performance.

When V_{IN} is required to provide large current instantaneously, a large effective input capacitor is required. Multiple input capacitors can limit the input tracking inductance. Adding more input capacitors is available to restrict the ringing and to keep it below the device absolute maximum ratings.

Output Capacitor Selection (C_{OUT})

The output decoupling capacitor should be located as close as possible to the VOUT pin. 1µF or larger X7R or X5R ceramic capacitor is selected to get good

dynamic performance. The minimum effective capacitance of C_{OUT} that SGM2202 can remain stable is 0.5µF. For ceramic capacitor, temperature, DC bias and package size will change the effective capacitance, so enough margin of C_{OUT} must be considered in design. Larger capacitance and lower ESR C_{OUT} will help improve the load transient response and increase the high frequency PSRR.

Thermal Shutdown

The SGM2202 can detect the temperature of die. When the die temperature exceeds the threshold value of thermal shutdown, the SGM2202 will be in shutdown state and it will remain in this state until the die temperature decreases to +130°C.

REVISION HISTORY

NOTE: Page numbers for previous revisions may differ from page numbers in the current version.

Table with 2 columns: Revision Description and Page. Includes entries for 'OCTOBER 2020 - REV.A.1 to REV.A.2' and 'Changes from Original (APRIL 2017) to REV.A'.

PACKAGE OUTLINE DIMENSIONS

SOT-23-5

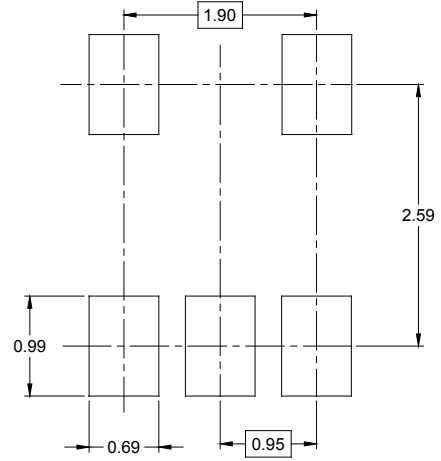
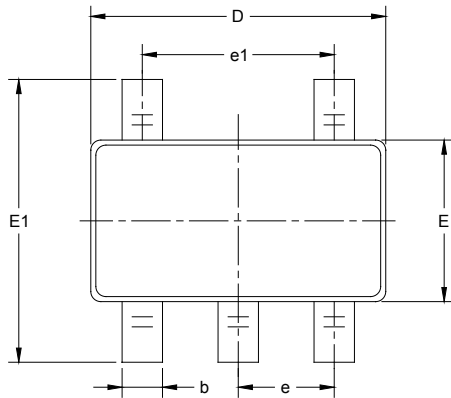

RECOMMENDED LAND PATTERN (Unit: mm)

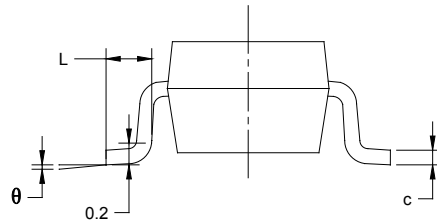
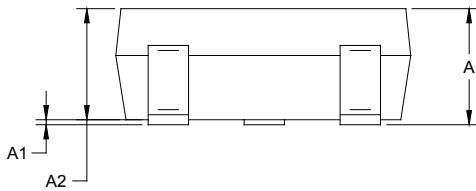

Symbol	Dimensions In Millimeters		Dimensions In Inches	
	MIN	MAX	MIN	MAX
A	1.050	1.250	0.041	0.049
A1	0.000	0.100	0.000	0.004
A2	1.050	1.150	0.041	0.045
b	0.300	0.500	0.012	0.020
c	0.100	0.200	0.004	0.008
D	2.820	3.020	0.111	0.119
E	1.500	1.700	0.059	0.067
E1	2.650	2.950	0.104	0.116
e	0.950 BSC		0.037 BSC	
e1	1.900 BSC		0.075 BSC	
L	0.300	0.600	0.012	0.024
θ	0°	8°	0°	8°

PACKAGE OUTLINE DIMENSIONS

SOT-23-6

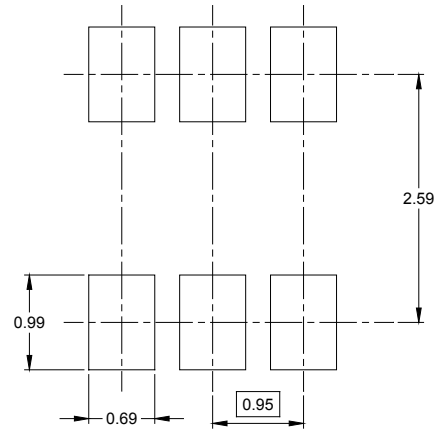
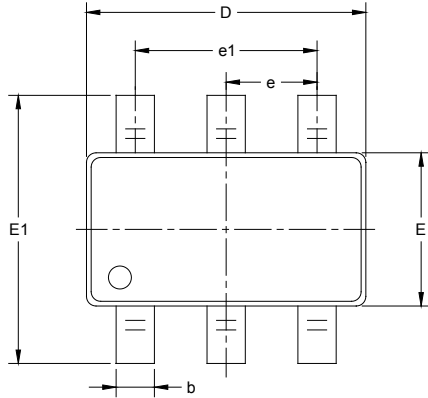

RECOMMENDED LAND PATTERN (Unit: mm)

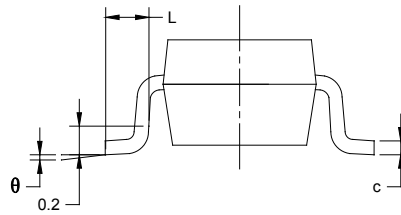
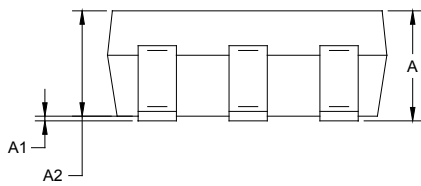

Symbol	Dimensions In Millimeters		Dimensions In Inches	
	MIN	MAX	MIN	MAX
A	1.050	1.250	0.041	0.049
A1	0.000	0.100	0.000	0.004
A2	1.050	1.150	0.041	0.045
b	0.300	0.500	0.012	0.020
c	0.100	0.200	0.004	0.008
D	2.820	3.020	0.111	0.119
E	1.500	1.700	0.059	0.067
E1	2.650	2.950	0.104	0.116
e	0.950 BSC		0.037 BSC	
e1	1.900 BSC		0.075 BSC	
L	0.300	0.600	0.012	0.024
θ	0°	8°	0°	8°

PACKAGE INFORMATION

TAPE AND REEL INFORMATION

REEL DIMENSIONS

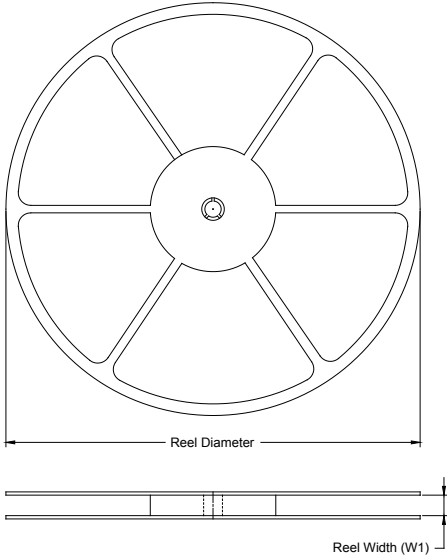

TAPE DIMENSIONS

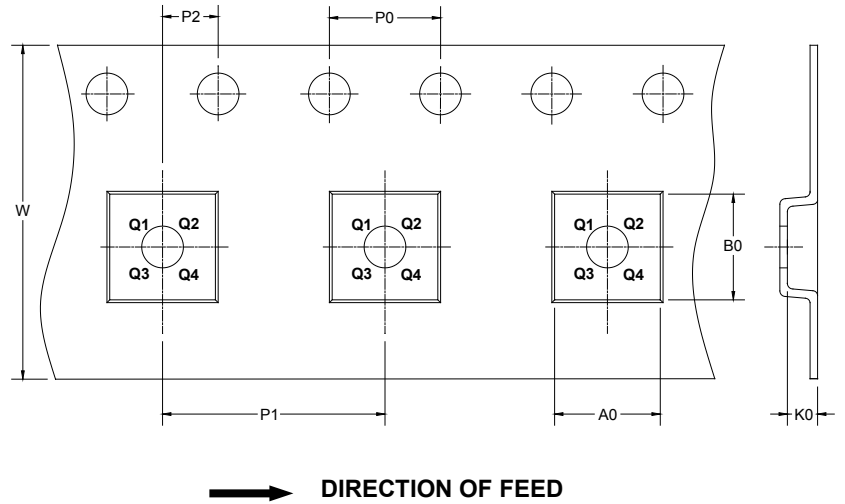

NOTE: The picture is only for reference. Please make the object as the standard.

KEY PARAMETER LIST OF TAPE AND REEL

Package Type	Reel Diameter	Reel Width W1 (mm)	A0 (mm)	B0 (mm)	K0 (mm)	P0 (mm)	P1 (mm)	P2 (mm)	W (mm)	Pin1 Quadrant
SOT-23-5	7"	9.5	3.20	3.20	1.40	4.0	4.0	2.0	8.0	Q3
SOT-23-6	7"	9.5	3.17	3.23	1.37	4.0	4.0	2.0	8.0	Q3

DD0001

PACKAGE INFORMATION

CARTON BOX DIMENSIONS



NOTE: The picture is only for reference. Please make the object as the standard.

KEY PARAMETER LIST OF CARTON BOX

Reel Type	Length (mm)	Width (mm)	Height (mm)	Pizza/Carton
7" (Option)	368	227	224	8
7"	442	410	224	18

DD0002