

GENERAL DESCRIPTION

The SGM2022 is a dual, low dropout, low voltage and high accuracy linear regulator. It is capable of supplying 250mA output current at each channel with typical dropout voltage of only 250mV. The operating input voltage range is from 2.5V to 5.5V.

Other features include logic-controlled shutdown mode, output current limit and thermal shutdown protection.

The SGM2022 is available in a Green SOT-23-6 package. It operates over an operating temperature range of -40°C to +85°C.

FEATURES

- **Operating Input Voltage Range: 2.5V to 5.5V**
- **Output Voltage Accuracy: ±2% at +25°C**
- **Low Dropout Voltage: 250mV (TYP) at 250mA**
- **High PSRR: 71dB (TYP) at 100Hz**
- **Shutdown Current: 0.01µA (TYP)**
- **Low No Load Supply Current: 190µA (TYP)**
- **Thermal Shutdown Protection**
- **Output Current Limit**
- **-40°C to +85°C Operating Temperature Range**
- **Available in a Green SOT-23-6 Package**

APPLICATIONS

- Modems
- MP3 Players
- Wireless LAN
- Cellular Telephones
- PCMCIA Cards
- Palmtop Computers
- Portable Electronics

TYPICAL APPLICATION

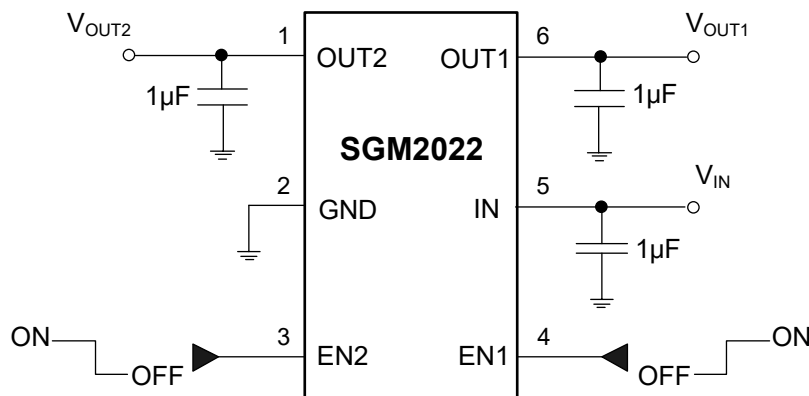

Figure 1. Typical Application Circuit

PACKAGE/ORDERING INFORMATION

ORDERING NUMBER	V _{OUT1}	V _{OUT2}	PACKAGE DESCRIPTION	SPECIFIED TEMPERATURE RANGE	PACKAGE MARKING	PACKING OPTION
SGM2022-AYN6/TR	2.8V	2.8V	SOT-23-6	-40°C to +85°C	2022A	Tape and Reel, 3000
SGM2022-CYN6/TR	2.8V	3.0V	SOT-23-6	-40°C to +85°C	2022C	Tape and Reel, 3000
SGM2022-DYN6/TR	2.8V	2.5V	SOT-23-6	-40°C to +85°C	2022D	Tape and Reel, 3000
SGM2022-EYN6/TR	2.8V	1.8V	SOT-23-6	-40°C to +85°C	2022E	Tape and Reel, 3000
SGM2022-GYN6/TR	2.5V	1.8V	SOT-23-6	-40°C to +85°C	2022G	Tape and Reel, 3000
SGM2022-HYN6/TR	3.3V	2.5V	SOT-23-6	-40°C to +85°C	2022H	Tape and Reel, 3000
SGM2022-IYN6/TR	3.3V	1.8V	SOT-23-6	-40°C to +85°C	2022I	Tape and Reel, 3000
SGM2022-KYN6/TR	3.0V	1.8V	SOT-23-6	-40°C to +85°C	2022K	Tape and Reel, 3000
SGM2022-MYN6/TR	2.8V	1.2V	SOT-23-6	-40°C to +85°C	2022M	Tape and Reel, 3000
SGM2022-NYN6/TR	2.8V	1.3V	SOT-23-6	-40°C to +85°C	2022N	Tape and Reel, 3000
SGM2022-OYN6/TR	2.8V	1.5V	SOT-23-6	-40°C to +85°C	2022O	Tape and Reel, 3000
SGM2022-PYN6/TR	1.5V	2.8V	SOT-23-6	-40°C to +85°C	2022P	Tape and Reel, 3000
SGM2022-QYN6/TR	2.5V	1.5V	SOT-23-6	-40°C to +85°C	2022Q	Tape and Reel, 3000
SGM2022-RYN6/TR	2.5V	2.8V	SOT-23-6	-40°C to +85°C	2022R	Tape and Reel, 3000
SGM2022-SYN6/TR	1.3V	2.8V	SOT-23-6	-40°C to +85°C	2022S	Tape and Reel, 3000
SGM2022-TYN6/TR	1.5V	3.3V	SOT-23-6	-40°C to +85°C	2022T	Tape and Reel, 3000
SGM2022-UYN6/TR	3.3V	3.0V	SOT-23-6	-40°C to +85°C	2022U	Tape and Reel, 3000
SGM2022-VYN6/TR	1.8V	3.3V	SOT-23-6	-40°C to +85°C	2022V	Tape and Reel, 3000
SGM2022-WYN6/TR	1.2V	2.8V	SOT-23-6	-40°C to +85°C	2022W	Tape and Reel, 3000
SGM2022-XYN6/TR	3.3V	2.8V	SOT-23-6	-40°C to +85°C	2022X	Tape and Reel, 3000
SGM2022-YYN6/TR	1.8V	2.8V	SOT-23-6	-40°C to +85°C	2022Y	Tape and Reel, 3000
SGM2022-ZYN6/TR	1.8V	1.8V	SOT-23-6	-40°C to +85°C	2022Z	Tape and Reel, 3000
SGM2022-AAYN6/TR	1.2V	1.8V	SOT-23-6	-40°C to +85°C	2022AA	Tape and Reel, 3000

Green (RoHS & HSF): SG Micro Corp defines "Green" to mean Pb-Free (RoHS compatible) and free of halogen substances. If you have additional comments or questions, please contact your SGMICRO representative directly.

ORDER NUMBER

SGM2022- X Y X / TR

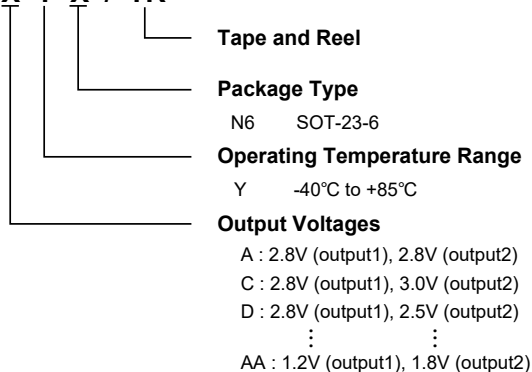

ABSOLUTE MAXIMUM RATINGS

IN to GND	-0.3V to 6V
Output Short-Circuit Duration.....	Infinite
EN to GND.....	-0.3V to V_{IN}
OUT to GND	-0.3V to $(V_{IN} + 0.3V)$
Power Dissipation, P_D @ $T_A = 25^\circ C$	
SOT-23-6	0.24W
Package Thermal Resistance	
SOT-23-6, θ_{JA}	250°C/W
Junction Temperature.....	+150°C
Storage Temperature Range	-65°C to +150°C
Lead Temperature (Soldering, 10s).....	+260°C
ESD	
HBM.....	4000V
MM.....	400V

RECOMMENDED OPERATING CONDITIONS

Operating Temperature Range	-40°C to +85°C
-----------------------------------	----------------

OVERSTRESS CAUTION

Stresses beyond those listed in Absolute Maximum Ratings may cause permanent damage to the device. Exposure to absolute maximum rating conditions for extended periods may affect reliability. Functional operation of the device at any conditions beyond those indicated in the Recommended Operating Conditions section is not implied.

ESD SENSITIVITY CAUTION

This integrated circuit can be damaged if ESD protections are not considered carefully. SGMICRO recommends that all integrated circuits be handled with appropriate precautions. Failure to observe proper handling and installation procedures can cause damage. ESD damage can range from subtle performance degradation to complete device failure. Precision integrated circuits may be more susceptible to damage because even small parametric changes could cause the device not to meet the published specifications.

DISCLAIMER

SG Micro Corp reserves the right to make any change in circuit design, or specifications without prior notice.

PIN CONFIGURATION

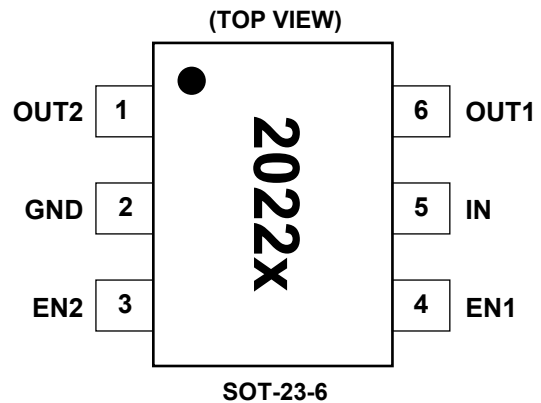

NOTE: The location of pin 1 on the 2022x is determined by orienting the package marking as shown.

PIN DESCRIPTION

PIN	NAME	FUNCTION
1	OUT2	Channel 2 Output Voltage Pin.
2	GND	Ground.
3	EN2	Channel 2 Enable Pin. Drive EN2 high to turn on the channel 2 output. Drive EN2 low to put the channel 2 regulator into shutdown mode. If EN1 and EN2 are both low, both regulators and the reference turn off.
4	EN1	Channel 1 Enable Pin. Drive EN1 high to turn on the channel 1 output. Drive EN1 low to put the channel 1 regulator into shutdown mode. If EN1 and EN2 are both low, both regulators and the reference turn off.
5	IN	Supply Input.
6	OUT1	Channel 1 Output Voltage.

ELECTRICAL CHARACTERISTICS

($V_{IN} = V_{OUT(NOMINAL)} + 0.5V$ or $2.5V$ (whichever is greater), $T_A = -40^{\circ}C$ to $+85^{\circ}C$, typical values are at $T_A = +25^{\circ}C$, for each LDO unless otherwise specified.)

PARAMETER	SYMBOL	CONDITIONS	MIN	TYP	MAX	UNITS
Input Voltage Range	V_{IN}		2.5		5.5	V
Output Voltage Accuracy		$I_{OUT} = 0.1mA$, $T_A = +25^{\circ}C$	-2		+2	%
Maximum Output Current ⁽³⁾			250			mA
Output Current Limit	I_{LIM}		310	500		mA
Ground Pin Current	I_Q	EN = 2V, both LDOs No Load		190	295	μA
Dropout Voltage ⁽¹⁾		$I_{OUT} = 1mA$		1		mV
		$I_{OUT} = 250mA$		250	350	
Line Regulation	$\frac{\Delta V_{OUT}}{\Delta V_{IN} \times V_{OUT}}$	$V_{IN} = 2.5V$ or $(V_{OUT} + 0.5V)$ to $5.5V$, $I_{OUT} = 1mA$		0.02	0.15	%/V
Load Regulation	$\frac{\Delta V_{OUT}}{\Delta I_{LOAD} \times V_{OUT}}$	$I_{OUT} = 0.1mA$ to $250mA$, $C_{OUT} = 1\mu F$		0.004	0.01	%/mA
Power Supply Rejection Rate	PSRR	$I_{OUT} = 50mA$, $C_{OUT} = 1\mu F$, $f = 100Hz$		71		dB
Shutdown						
EN Input Threshold	V_{IH}	$V_{IN} = 2.5V$ to $5.5V$		1.5		V
	V_{IL}					
EN Input Bias Current	$I_{B(SHDN)}$	EN = 0V or EN = 5.5V	$T_A = +25^{\circ}C$	0.01	1	μA
			$T_A = +85^{\circ}C$	0.01		
Shutdown Supply Current	$I_{Q(SHDN)}$	EN1 = EN2 = 0.4V	$T_A = +25^{\circ}C$	0.01	1	μA
			$T_A = +85^{\circ}C$	0.01		
Shutdown Exit Delay ⁽²⁾		$C_{OUT} = 1\mu F$, No Load	$T_A = +25^{\circ}C$	20		μs
Thermal Protection						
Thermal Shutdown Temperature	T_{SHDN}			160		$^{\circ}C$
Thermal Shutdown Hysteresis	ΔT_{SHDN}			15		$^{\circ}C$

NOTES:

- The dropout voltage is defined as $V_{IN} - V_{OUT}$, when V_{OUT} is 100mV below the value of V_{OUT} for $V_{IN} = V_{OUT} + 0.5V$.
(Only applicable for $V_{OUT} = 2.5V$ to $3.3V$)
- Time needed for V_{OUT} to reach 95% of final value.
- Each channel provides 300mA of maximum output current when the condition of dissipating heat is good.

TYPICAL PERFORMANCE CHARACTERISTICS

$V_{IN} = V_{OUT (NOMINAL)} + 0.5V$ or $2.5V$ (whichever is greater), $C_{IN} = 1\mu F$, $C_{OUT} = 1\mu F$, $T_A = +25^\circ C$, unless otherwise noted.

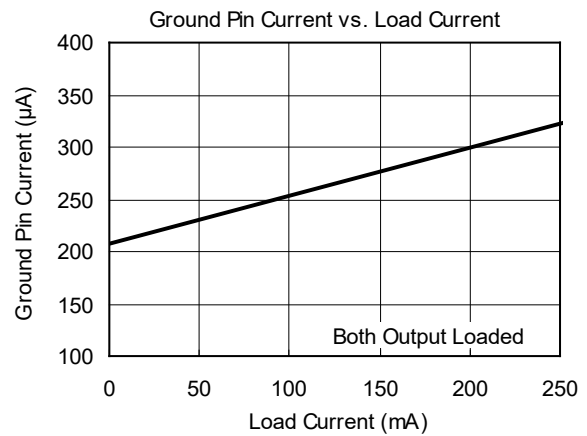
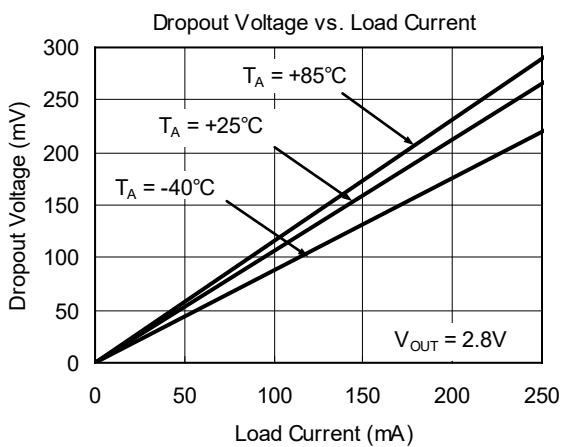
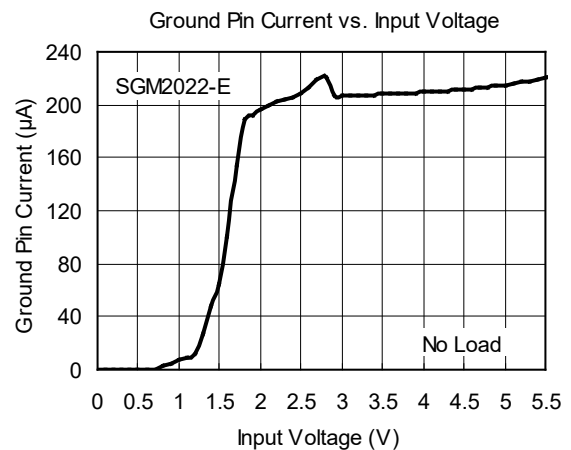
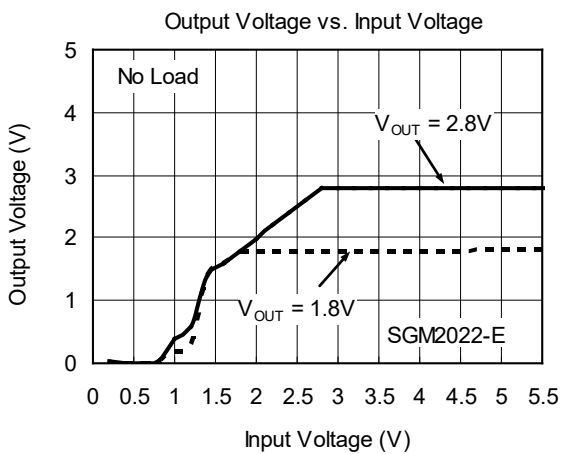
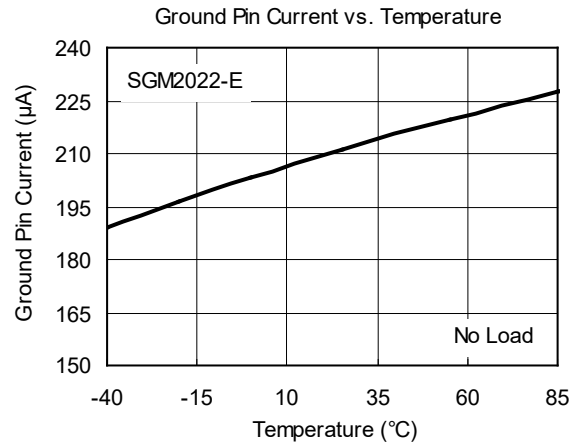
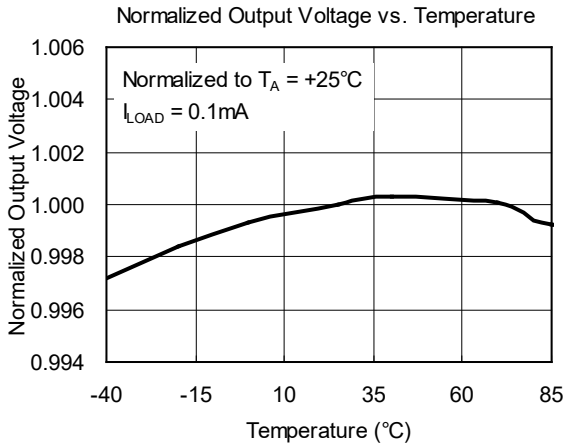

TYPICAL PERFORMANCE CHARACTERISTICS (continued)

$V_{IN} = V_{OUT(NOMINAL)} + 0.5V$ or $2.5V$ (whichever is greater), $C_{IN} = 1\mu F$, $C_{OUT} = 1\mu F$, $T_A = +25^\circ C$, unless otherwise noted.

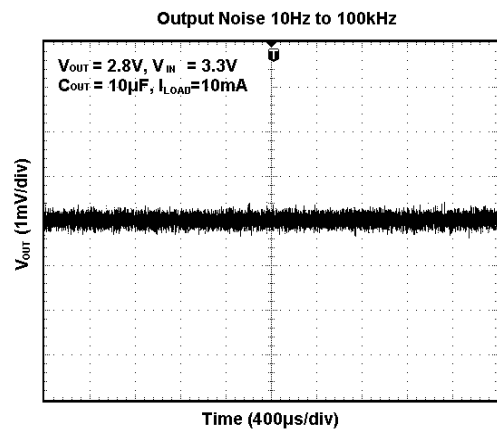
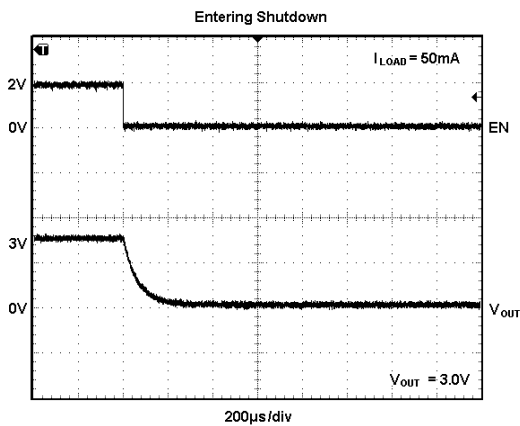
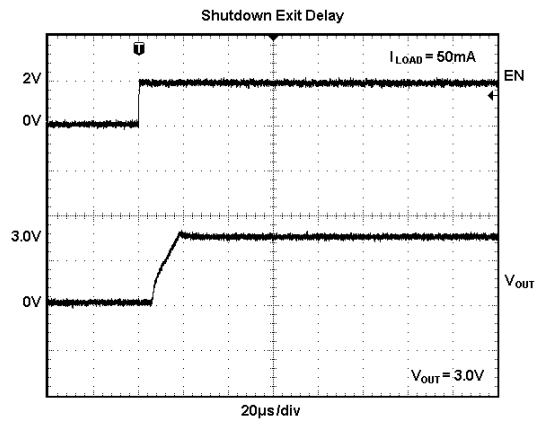
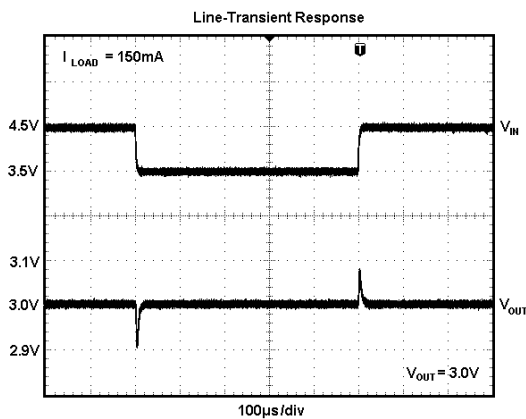
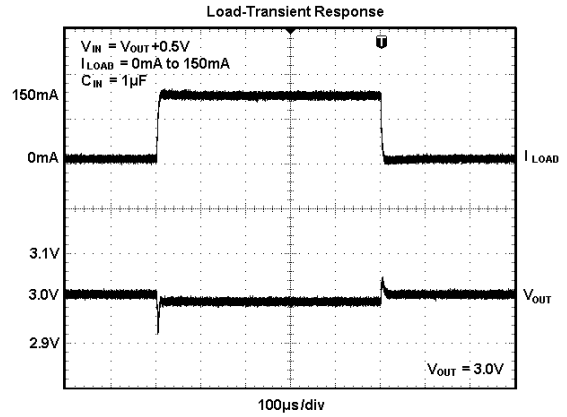
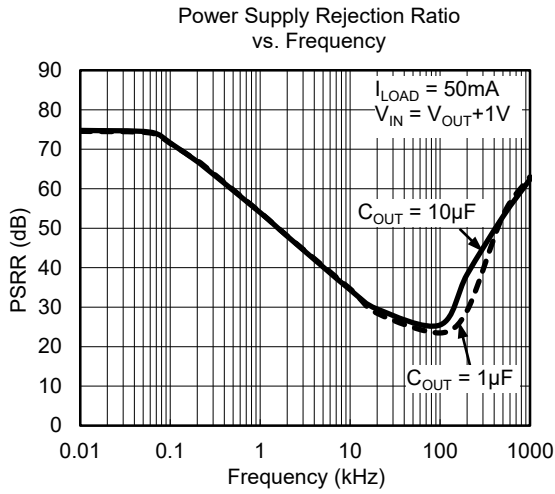

APPLICATION INFORMATION

Input Capacitor Selection (C_{IN})

The input decoupling capacitor is necessary to be connected as close as possible to the IN pin for ensuring the device stability. 1 μ F or larger X7R or X5R ceramic capacitor is selected to get good dynamic performance.

When V_{IN} is required to provide large current instantaneously, a large effective input capacitor is required. Multiple input capacitors can limit the input tracking inductance. Adding more input capacitors is available to restrict the ringing and to keep it below the device absolute maximum ratings.

Output Capacitors Selection (C_{OUT1} , C_{OUT2})

The output decoupling capacitors should be located as close as possible to the OUTx pins. 1 μ F or larger X7R or X5R ceramic capacitors are selected to get good dynamic performance. For ceramic capacitor, temperature, DC bias and package size will change the effective capacitance, so enough margins of C_{OUT1} and C_{OUT2} must be considered in design. Larger capacitance and lower ESR C_{OUT1} and C_{OUT2} will help improve the load transient response and increase the high frequency PSRR.

Output Current Limit and Short-Circuit Protection

When overload events happen, the output current is internally limited to 500mA (TYP). When the OUT pin is shorted to ground, the short-circuit protection will limit the output current.

Thermal Shutdown

The SGM2022 can detect the temperature of die. When the die temperature exceeds the threshold value of thermal shutdown, the SGM2022 will be in shutdown state and it will remain in this state until the die temperature decreases to +145°C.

Layout Guidelines

To get good PSRR, low output noise and high transient response performance, the input and output bypass capacitors must be placed as close as possible to the IN pin and OUTx pins separately. V_{IN} and V_{OUT} had better use separate ground planes and these ground planes are single point connected to the GND pin.

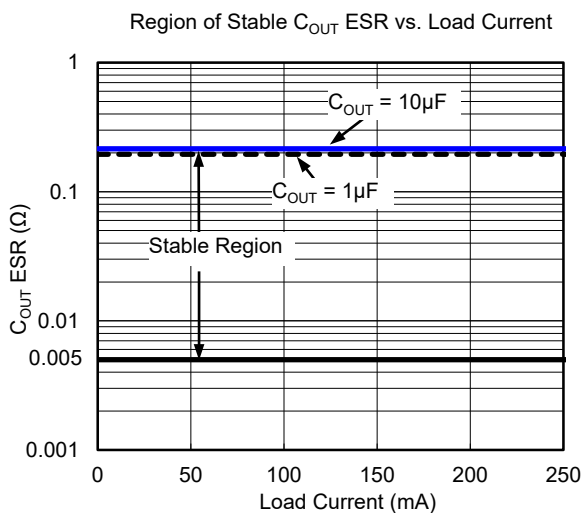

REVISION HISTORY

NOTE: Page numbers for previous revisions may differ from page numbers in the current version.

APRIL 2016 – REV.D to REV.D.1

Page

Changed Normalized Output Voltage vs. Temperature6

PACKAGE OUTLINE DIMENSIONS

SOT-23-6

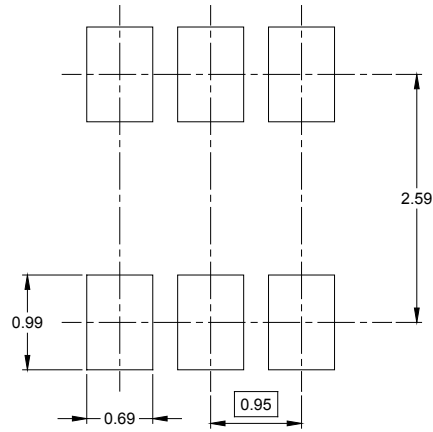
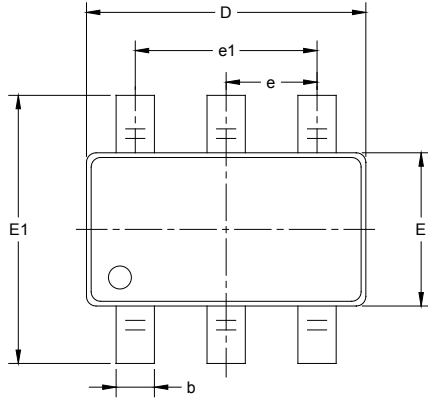

RECOMMENDED LAND PATTERN (Unit: mm)

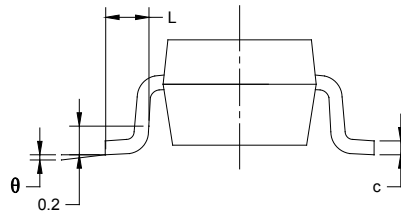
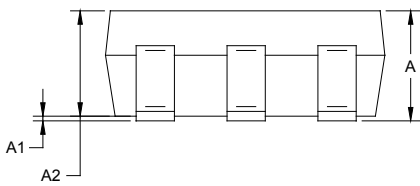

Symbol	Dimensions In Millimeters		Dimensions In Inches	
	MIN	MAX	MIN	MAX
A	1.050	1.250	0.041	0.049
A1	0.000	0.100	0.000	0.004
A2	1.050	1.150	0.041	0.045
b	0.300	0.500	0.012	0.020
c	0.100	0.200	0.004	0.008
D	2.820	3.020	0.111	0.119
E	1.500	1.700	0.059	0.067
E1	2.650	2.950	0.104	0.116
e	0.950 BSC		0.037 BSC	
e1	1.900 BSC		0.075 BSC	
L	0.300	0.600	0.012	0.024
θ	0°	8°	0°	8°

TAPE AND REEL INFORMATION

REEL DIMENSIONS



TAPE DIMENSIONS



NOTE: The picture is only for reference. Please make the object as the standard.

KEY PARAMETER LIST OF TAPE AND REEL

Package Type	Reel Diameter	Reel Width W1 (mm)	A0 (mm)	B0 (mm)	K0 (mm)	P0 (mm)	P1 (mm)	P2 (mm)	W (mm)	Pin1 Quadrant
SOT-23-6	7"	9.5	3.17	3.23	1.37	4.0	4.0	2.0	8.0	Q3

000001

PACKAGE INFORMATION

CARTON BOX DIMENSIONS



NOTE: The picture is only for reference. Please make the object as the standard.

KEY PARAMETER LIST OF CARTON BOX

Reel Type	Length (mm)	Width (mm)	Height (mm)	Pizza/Carton
7" (Option)	368	227	224	8
7"	442	410	224	18

DD0002