

### GENERAL DESCRIPTION

The SGM2021 is a low power and low dropout voltage RF linear regulator. It is capable of supplying 300mA output current with typical dropout voltage of only 270mV. The operating input voltage range is from 2.5V to 5.5V. The fixed output voltage range is from 0.9V to 5.0V.

Other features include output current limit and thermal shutdown protection.

The SGM2021 is available in a Green SOT-23-3 package. It operates over an operating temperature range of -40°C to +85°C.

### APPLICATIONS

- Modems
- MP3 Players
- Cellular Telephones
- PCMCIA Cards
- Palmtop Computers
- Portable Electronics

### TYPICAL APPLICATION

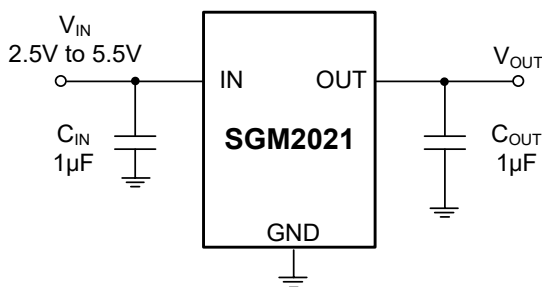
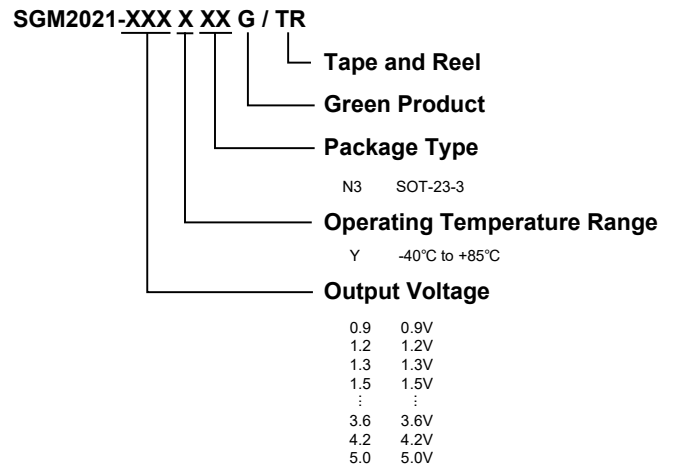

Figure 1. Typical Application Circuit

### FEATURES

- **Operating Input Voltage Range: 2.5V to 5.5V**
- **Fixed Output Voltages:**  
0.9V, 1.2V, 1.3V, 1.5V, 1.8V, 2.1V, 2.5V, 2.6V, 2.7V, 2.8V, 2.85V, 2.9V, 3.0V, 3.1V, 3.2V, 3.3V, 3.6V, 4.2V and 5.0V
- **Output Voltage Accuracy: ±2.5% at +25°C**
- **Low Output Noise: 140µV<sub>RMS</sub> (TYP)**
- **Low Dropout Voltage: 270mV (TYP) at 300mA**
- **High PSRR: 69dB (TYP) at 100Hz**
- **Low No Load Supply Current: 120µA (TYP)**
- **Thermal Shutdown Protection**
- **Output Current Limit**
- **-40°C to +85°C Operating Temperature Range**
- **Available in a Green SOT-23-3 Package**

### PRODUCT NAME STRUCTURE



**SGM2021**

**PACKAGE/ORDERING INFORMATION**

MODEL	V <sub>OUT</sub> (V)	PACKAGE DESCRIPTION	SPECIFIED TEMPERATURE RANGE	ORDERING NUMBER	PACKAGE MARKING	PACKING OPTION
SGM2021-0.9	0.9V	SOT-23-3	-40°C to +85°C	SGM2021-0.9YN3G/TR	YL09	Tape and Reel, 3000
SGM2021-1.2	1.2V	SOT-23-3	-40°C to +85°C	SGM2021-1.2YN3G/TR	YL12	Tape and Reel, 3000
SGM2021-1.3	1.3V	SOT-23-3	-40°C to +85°C	SGM2021-1.3YN3G/TR	YL13	Tape and Reel, 3000
SGM2021-1.5	1.5V	SOT-23-3	-40°C to +85°C	SGM2021-1.5YN3G/TR	YL15	Tape and Reel, 3000
SGM2021-1.8	1.8V	SOT-23-3	-40°C to +85°C	SGM2021-1.8YN3G/TR	YL18	Tape and Reel, 3000
SGM2021-2.1	2.1V	SOT-23-3	-40°C to +85°C	SGM2021-2.1YN3G/TR	YL21	Tape and Reel, 3000
SGM2021-2.5	2.5V	SOT-23-3	-40°C to +85°C	SGM2021-2.5YN3G/TR	YL25	Tape and Reel, 3000
SGM2021-2.6	2.6V	SOT-23-3	-40°C to +85°C	SGM2021-2.6YN3G/TR	YL26	Tape and Reel, 3000
SGM2021-2.7	2.7V	SOT-23-3	-40°C to +85°C	SGM2021-2.7YN3G/TR	YL27	Tape and Reel, 3000
SGM2021-2.8	2.8V	SOT-23-3	-40°C to +85°C	SGM2021-2.8YN3G/TR	YL28	Tape and Reel, 3000
SGM2021-2.85	2.85V	SOT-23-3	-40°C to +85°C	SGM2021-2.85YN3G/TR	YL2J	Tape and Reel, 3000
SGM2021-2.9	2.9V	SOT-23-3	-40°C to +85°C	SGM2021-2.9YN3G/TR	YL29	Tape and Reel, 3000
SGM2021-3.0	3.0V	SOT-23-3	-40°C to +85°C	SGM2021-3.0YN3G/TR	YL30	Tape and Reel, 3000
SGM2021-3.1	3.1V	SOT-23-3	-40°C to +85°C	SGM2021-3.1YN3G/TR	YL31	Tape and Reel, 3000
SGM2021-3.2	3.2V	SOT-23-3	-40°C to +85°C	SGM2021-3.2YN3G/TR	YL32	Tape and Reel, 3000
SGM2021-3.3	3.3V	SOT-23-3	-40°C to +85°C	SGM2021-3.3YN3G/TR	YL33	Tape and Reel, 3000
SGM2021-3.6	3.6V	SOT-23-3	-40°C to +85°C	SGM2021-3.6YN3G/TR	YL36	Tape and Reel, 3000
SGM2021-4.2	4.2V	SOT-23-3	-40°C to +85°C	SGM2021-4.2YN3G/TR	YL42	Tape and Reel, 3000
SGM2021-5.0	5.0V	SOT-23-3	-40°C to +85°C	SGM2021-5.0YN3G/TR	YL50	Tape and Reel, 3000

Green (RoHS & HSF): SG Micro Corp defines "Green" to mean Pb-Free (RoHS compatible) and free of halogen substances. If you have additional comments or questions, please contact your SGMICRO representative directly.

## SGM2021

### ABSOLUTE MAXIMUM RATINGS

IN to GND .....	-0.3V to 6V
Output Short-Circuit Duration.....	Infinite
OUT to GND .....	-0.3V to (V <sub>IN</sub> + 0.3V)
Power Dissipation, P <sub>D</sub> @ T <sub>A</sub> = 25°C	
SOT-23-3 .....	0.4W
Package Thermal Resistance	
SOT-23-3, θ <sub>JA</sub> .....	250°C/W
Junction Temperature .....	+150°C
Storage Temperature Range .....	-65°C to +150°C
Lead Temperature (Soldering, 10s).....	+260°C
ESD Susceptibility	
HBM.....	4000V
MM.....	400V

### RECOMMENDED OPERATING CONDITIONS

Operating Temperature Range .....	-40°C to +85°C
-----------------------------------	----------------

### OVERSTRESS CAUTION

Stresses beyond those listed in Absolute Maximum Ratings may cause permanent damage to the device. Exposure to absolute maximum rating conditions for extended periods may affect reliability. Functional operation of the device at any conditions beyond those indicated in the Recommended Operating Conditions section is not implied.

### ESD SENSITIVITY CAUTION

This integrated circuit can be damaged if ESD protections are not considered carefully. SGMICRO recommends that all integrated circuits be handled with appropriate precautions. Failure to observe proper handling and installation procedures can cause damage. ESD damage can range from subtle performance degradation to complete device failure. Precision integrated circuits may be more susceptible to damage because even small parametric changes could cause the device not to meet the published specifications.

### DISCLAIMER

SG Micro Corp reserves the right to make any change in circuit design, or specifications without prior notice.

### PIN CONFIGURATION

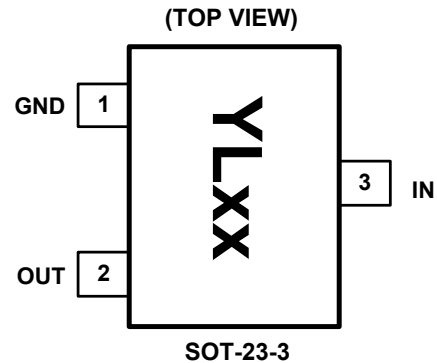

#### NOTE:

- (1) The location of pin 1 on the YLxx is determined by orienting the package marking as shown.
- (2) "xx" is the output voltage code. (For example: when the output voltage is 1.8V, it is expressed as 18.)

### PIN DESCRIPTION

PIN	NAME	FUNCTION
1	GND	Ground.
2	OUT	Regulator Output Pin.
3	IN	Regulator Input Pin. It is recommended to use a 1μF or larger ceramic capacitor from IN pin to ground.

**ELECTRICAL CHARACTERISTICS**(V<sub>IN</sub> = V<sub>OUT (NOMINAL)</sub> + 0.5V or 2.5V, whichever is greater, T<sub>A</sub> = +25°C, unless otherwise noted.)

PARAMETER	SYMBOL	CONDITIONS	MIN	TYP	MAX	UNITS	
Input Voltage	V <sub>IN</sub>		2.5		5.5	V	
Output Voltage Accuracy		I <sub>OUT</sub> = 0.1mA, T <sub>A</sub> = +25°C	-2.5		2.5	%	
Maximum Output Current			300			mA	
Current Limit	I <sub>LIM</sub>		310	500		mA	
Ground Pin Current	I <sub>Q</sub>	No load		120	220	μA	
Dropout Voltage <sup>(1)</sup>		I <sub>OUT</sub> = 1mA		0.9		mV	
		I <sub>OUT</sub> = 300mA		270	400		
Line Regulation	ΔV <sub>LNR</sub>	V <sub>IN</sub> = 2.5V or (V <sub>OUT</sub> + 0.5V) to 5.5V, I <sub>OUT</sub> = 1mA		0.02	0.05	%/V	
Load Regulation	ΔV <sub>LDR</sub>	I <sub>OUT</sub> = 0.1mA to 300mA, C <sub>OUT</sub> = 1μF, V <sub>OUT</sub> > 2V		0.002	0.005	%/mA	
		I <sub>OUT</sub> = 0.1mA to 300mA, C <sub>OUT</sub> = 1μF, V <sub>OUT</sub> ≤ 2V		0.004	0.008		
Output Voltage Noise	e <sub>n</sub>	f = 10Hz to 100kHz, C <sub>OUT</sub> = 10μF		140		μV <sub>RMS</sub>	
Power Supply Rejection Rate	PSRR	I <sub>OUT</sub> = 50mA, C <sub>OUT</sub> = 1μF, V <sub>IN</sub> = V <sub>OUT</sub> + 1V	f = 217Hz		62		dB
			f = 100Hz		69		dB
<b>Thermal Protection</b>							
Thermal Shutdown Temperature	T <sub>SHDN</sub>			150		°C	
Thermal Shutdown Hysteresis	ΔT <sub>SHDN</sub>			15		°C	

## NOTE:

- The dropout voltage is defined as V<sub>IN</sub> - V<sub>OUT</sub>, when V<sub>OUT</sub> is 100mV below the value of V<sub>OUT</sub> for V<sub>IN</sub> = V<sub>OUT</sub> + 0.5V (only applicable for V<sub>OUT</sub> = +2.5V to +5.0V).

TYPICAL PERFORMANCE CHARACTERISTICS

$V_{IN} = V_{OUT(NOMINAL)} + 0.5V$  or  $2.5V$  (whichever is greater),  $C_{IN} = 1\mu F$ ,  $C_{OUT} = 1\mu F$ ,  $T_A = +25^\circ C$ , unless otherwise noted.

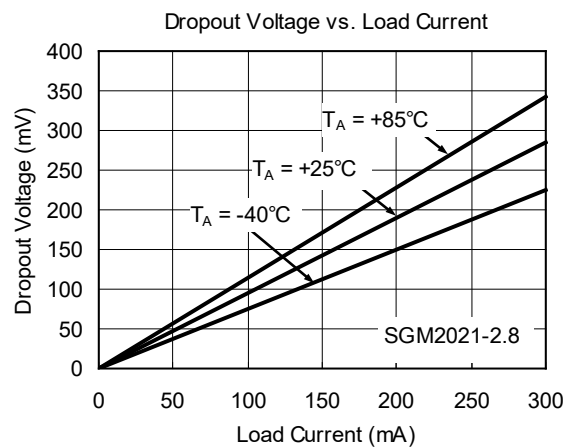
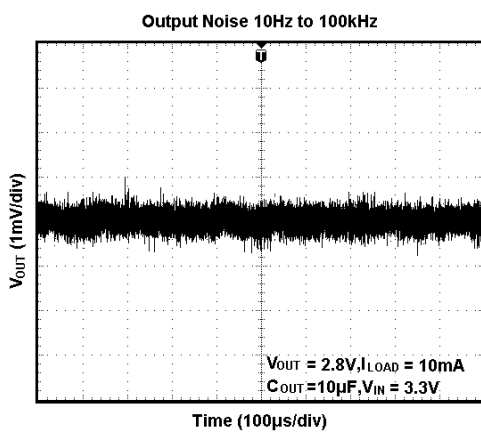
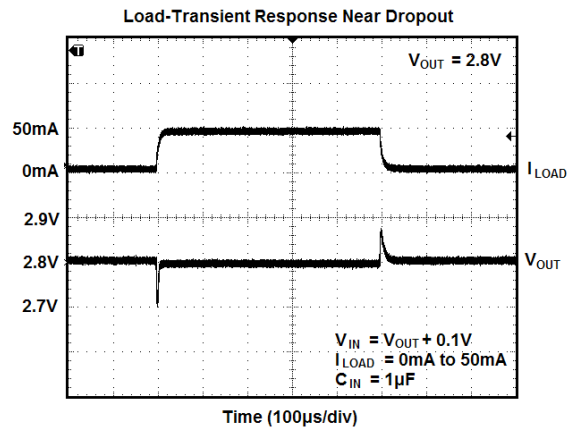
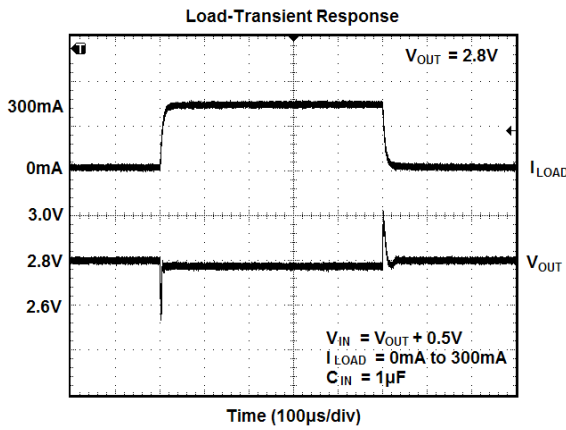
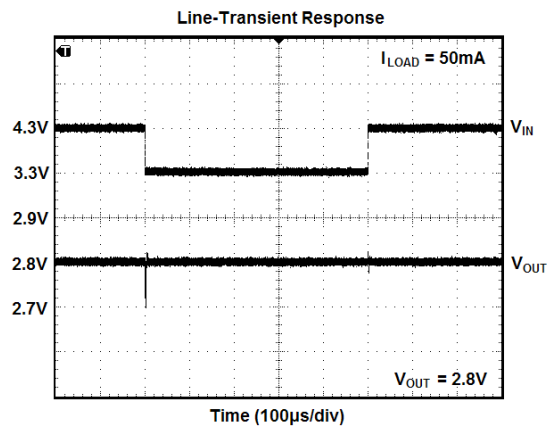
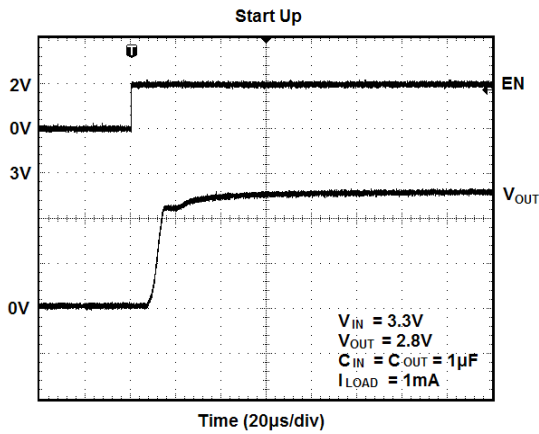

**TYPICAL PERFORMANCE CHARACTERISTICS (continued)**

$V_{IN} = V_{OUT(NOMINAL)} + 0.5V$  or  $2.5V$  (whichever is greater),  $C_{IN} = 1\mu F$ ,  $C_{OUT} = 1\mu F$ ,  $T_A = +25^\circ C$ , unless otherwise noted.

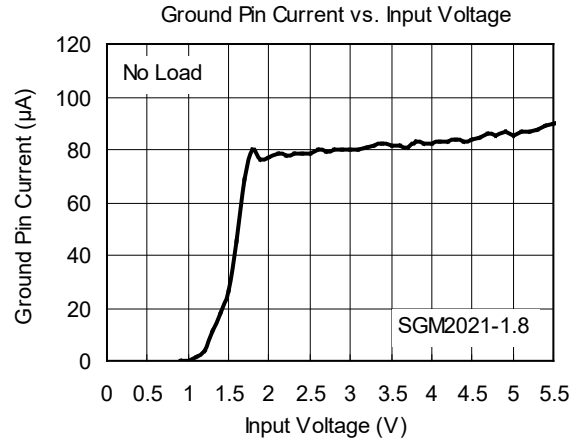
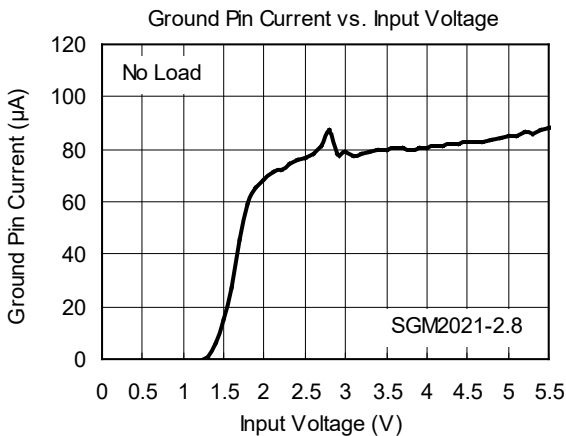
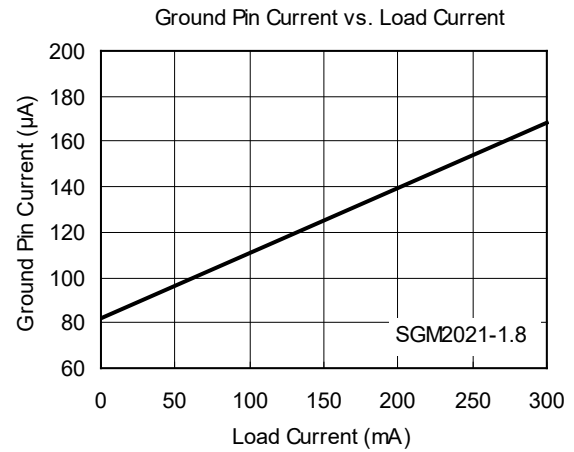
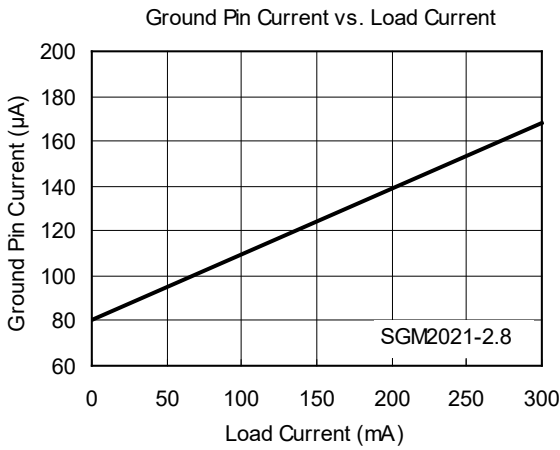
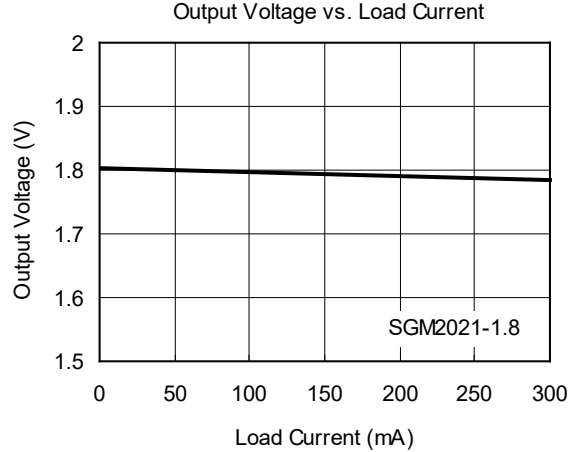
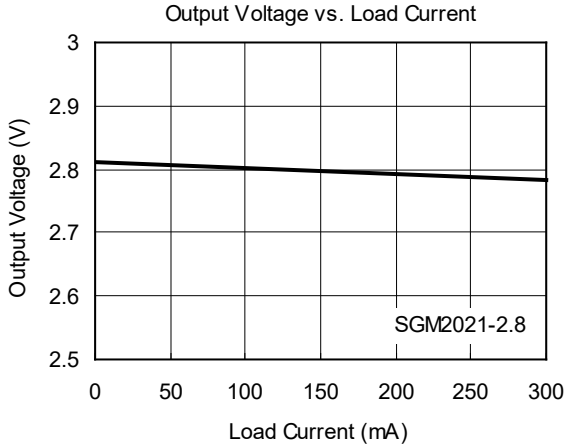

**TYPICAL PERFORMANCE CHARACTERISTICS (continued)**

$V_{IN} = V_{OUT(NOMINAL)} + 0.5V$  or  $2.5V$  (whichever is greater),  $C_{IN} = 1\mu F$ ,  $C_{OUT} = 1\mu F$ ,  $T_A = +25^\circ C$ , unless otherwise noted.

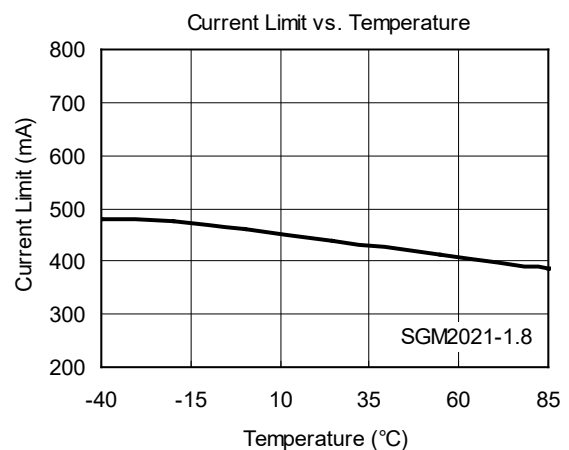
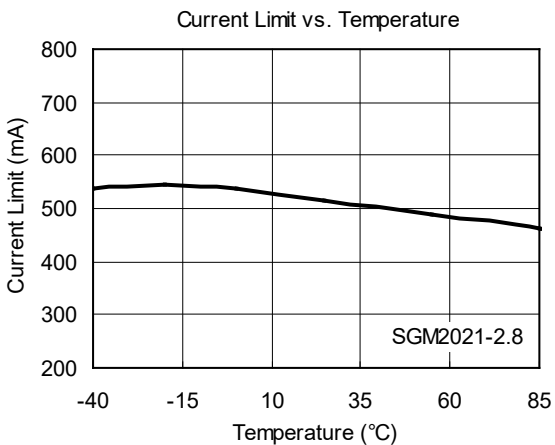
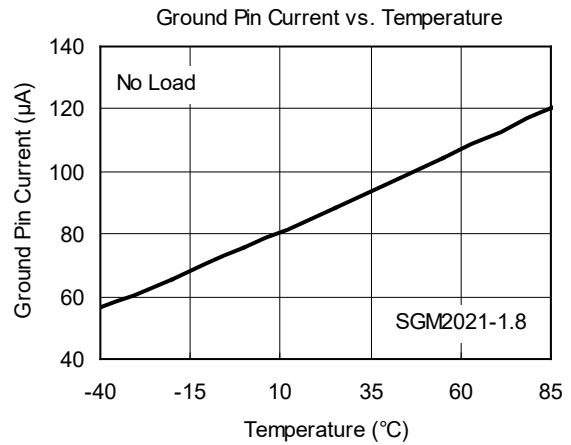
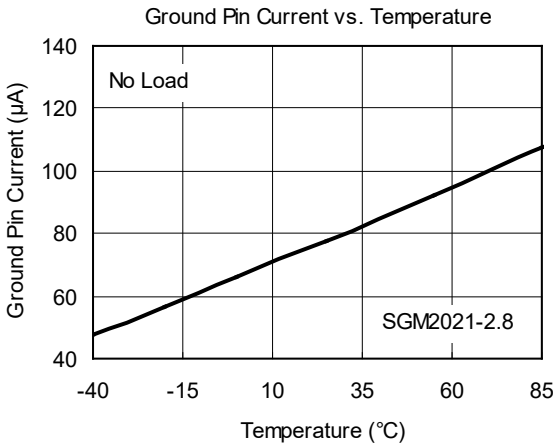
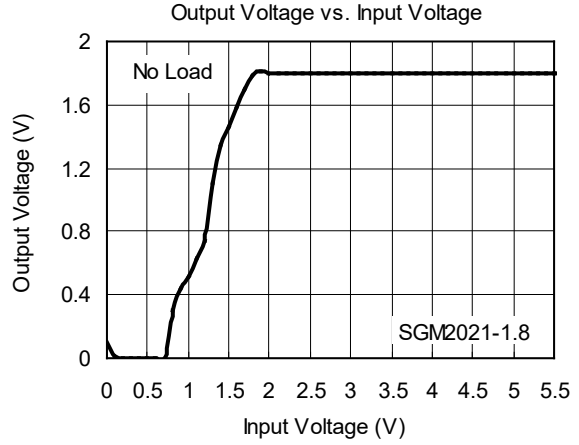
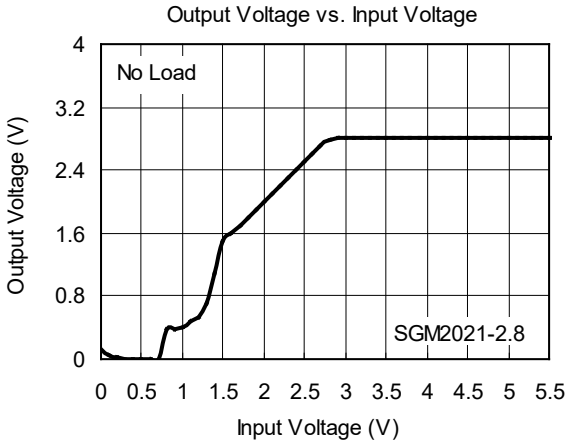

## SGM2021

### TYPICAL PERFORMANCE CHARACTERISTICS (continued)

$V_{IN} = V_{OUT(NOMINAL)} + 0.5V$  or  $2.5V$  (whichever is greater),  $C_{IN} = 1\mu F$ ,  $C_{OUT} = 1\mu F$ ,  $T_A = +25^\circ C$ , unless otherwise noted.

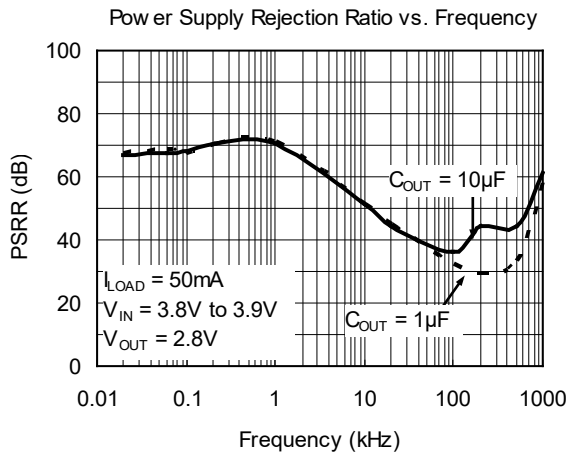
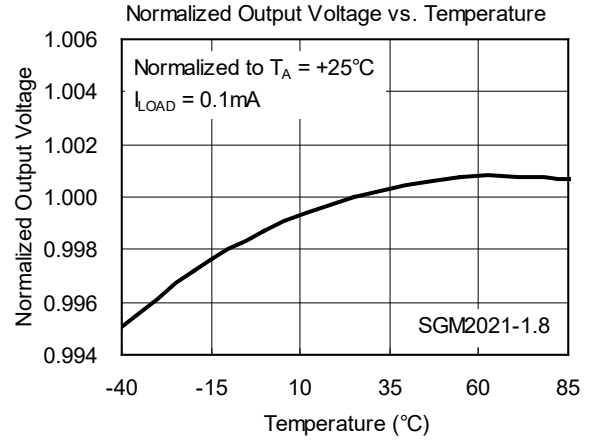
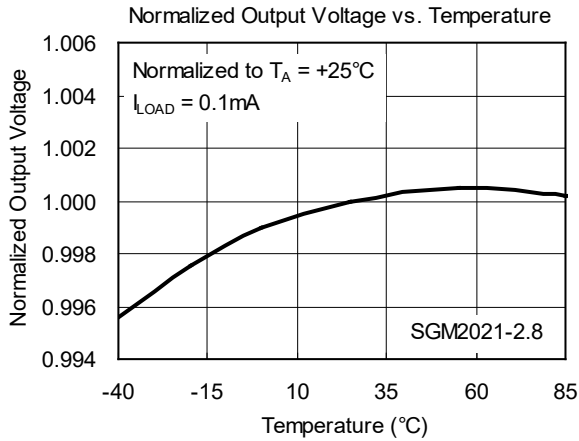



## APPLICATION INFORMATION

The SGM2021 is a low power and low dropout LDO and provides 300mA output current. These features make the device a reliable solution to solve many challenging problems in the generation of clean and accurate power supply. The high performance also makes the SGM2021 useful in a variety of applications. The SGM2021 provides protection functions for output overload, output short-circuit condition and overheating.

### Input Capacitor Selection ( $C_{IN}$ )

The input decoupling capacitor is necessary to be connected as close as possible to the IN pin for ensuring the device stability. 1 $\mu$ F or larger X7R or X5R ceramic capacitor is selected to get good dynamic performance.

When  $V_{IN}$  is required to provide large current instantaneously, a large effective input capacitor is required. Multiple input capacitors can limit the input tracking inductance. Adding more input capacitors is available to restrict the ringing and to keep it below the device absolute maximum ratings.

### Output Capacitor Selection ( $C_{OUT}$ )

The output decoupling capacitor should be located as close as possible to the OUT pin. 1 $\mu$ F or larger X7R or X5R ceramic capacitor is selected to get good dynamic performance. The minimum effective capacitance of  $C_{OUT}$  that SGM2021 can remain stable is 0.5 $\mu$ F. For ceramic capacitor, temperature, DC bias and package

size will change the effective capacitance, so enough margin of  $C_{OUT}$  must be considered in design. Larger capacitance and lower ESR  $C_{OUT}$  will help improve the load transient response and increase the high frequency PSRR.

### Output Current Limit and Short-Circuit Protection

When overload events happen, the output current is internally limited to 500mA (TYP). When the OUT pin is shorted to ground, the short-circuit protection will limit the output current.

### Thermal Shutdown

The SGM2021 can detect the temperature of die. When the die temperature exceeds the threshold value of thermal shutdown, the SGM2021 will be in shutdown state and it will remain in this state until the die temperature decreases to +135°C.

### Layout Guidelines

To get good PSRR, low output noise and high transient response performance, the input and output bypass capacitors must be placed as close as possible to the IN pin and OUT pin separately.  $V_{IN}$  and  $V_{OUT}$  had better use separate ground planes and these ground planes are single point connected to the GND pin.

## REVISION HISTORY

NOTE: Page numbers for previous revisions may differ from page numbers in the current version.

APRIL 2016 – REV.B to REV.B.1

Page

Changed Normalized Output Voltage vs. Temperature (SGM2021-2.8 and SGM2021-1.8) .....9

PACKAGE OUTLINE DIMENSIONS

SOT-23-3

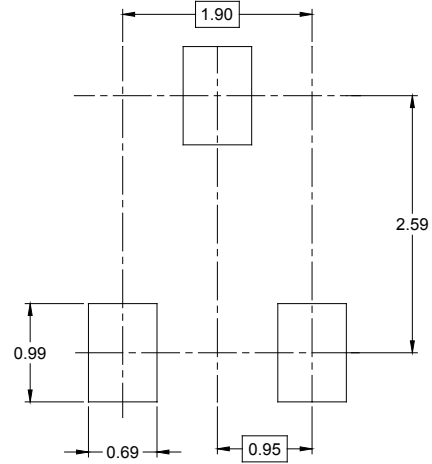
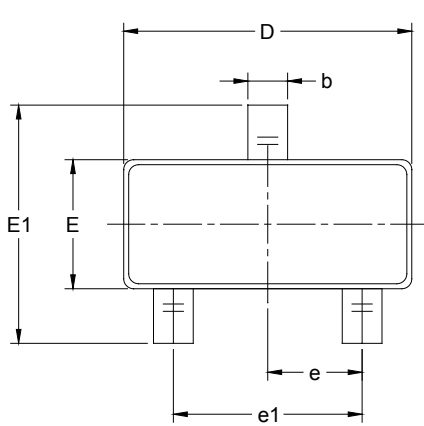

RECOMMENDED LAND PATTERN (Unit: mm)

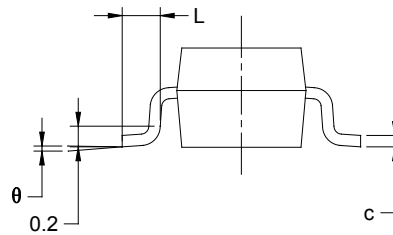
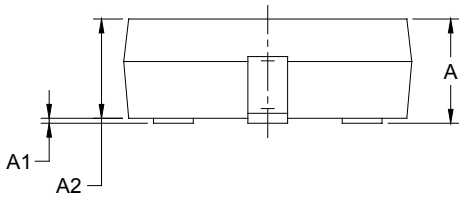

Symbol	Dimensions In Millimeters		Dimensions In Inches	
	MIN	MAX	MIN	MAX
A	1.050	1.250	0.041	0.049
A1	0.000	0.100	0.000	0.004
A2	1.050	1.150	0.041	0.045
b	0.300	0.500	0.012	0.020
c	0.100	0.200	0.004	0.008
D	2.820	3.020	0.111	0.119
E	1.500	1.700	0.059	0.067
E1	2.650	2.950	0.104	0.116
e	0.950 BSC		0.037 BSC	
e1	1.900 BSC		0.075 BSC	
L	0.300	0.600	0.012	0.024
$\theta$	0°	8°	0°	8°

**TAPE AND REEL INFORMATION**

**REEL DIMENSIONS**



**TAPE DIMENSIONS**



NOTE: The picture is only for reference. Please make the object as the standard.

**KEY PARAMETER LIST OF TAPE AND REEL**

Package Type	Reel Diameter	Reel Width W1 (mm)	A0 (mm)	B0 (mm)	K0 (mm)	P0 (mm)	P1 (mm)	P2 (mm)	W (mm)	Pin1 Quadrant
SOT-23-3	7"	9.0	3.20	3.30	1.30	4.0	4.0	2.0	8.0	Q3

DD0001

# PACKAGE INFORMATION

## CARTON BOX DIMENSIONS



NOTE: The picture is only for reference. Please make the object as the standard.

## KEY PARAMETER LIST OF CARTON BOX

Reel Type	Length (mm)	Width (mm)	Height (mm)	Pizza/Carton
7" (Option)	368	227	224	8
7"	442	410	224	18

DD0002