



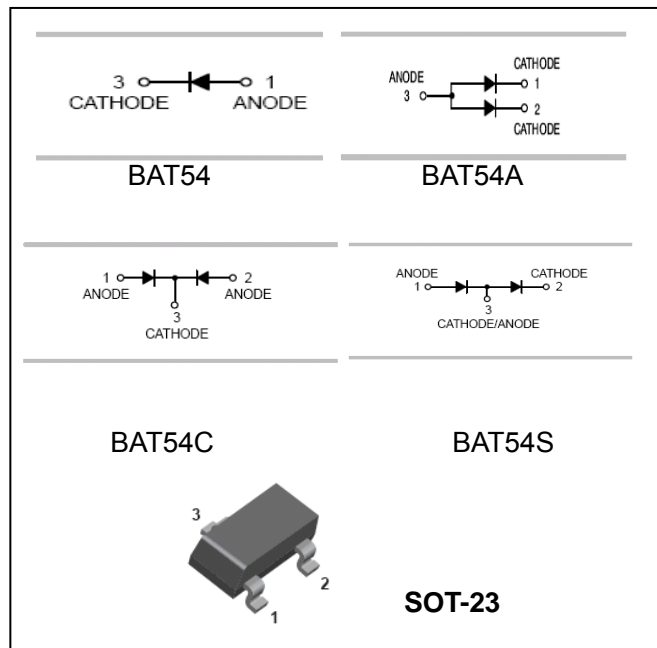
Surface Mount Schottky Barrier diode

FEATURES

- Fast switching .
- Low Turn-on voltage.
- PN Junction Guard Ring for Transient and ESD Protection.
- Available in Lead Free Version.
- MSL 3



Lead-free



ORDERING INFORMATION

Type No.	Marking	Package Code
BAT54	KL1	SOT-23
BAT54A	KL2	SOT-23
BAT54C	KL3	SOT-23
BAT54S	KL4	SOT-23

MAXIMUM RATING @ Ta=25°C unless otherwise specified

Parameter	Symbol	Limits	Unit
Peak Repetitive Peak reverse voltage	V_{RRM}	30	V
Working Peak Reverse Voltage	V_{RWM}		
DC Reverse Voltage	V_R		
Forward Continuous Current	I_F	200	mA
Power Dissipation	P_d	225	mW
Thermal resistance, junction to ambient air	$R_{\theta JA}$	500	°C/W
Thermal resistance, junction to case	$R_{\theta Jc}$	360	°C/W
Operating and Storage temperature	T_J, T_{STG}	-55 to +150	°C

Surface Mount Schottky Barrier diode
ELECTRICAL CHARACTERISTICS @ Ta=25°C unless otherwise specified

Parameter	Symbol	Min.	Typ.	Max.	Unit	Conditions
Reverse Breakdown Voltage	$V_{(BR)}$	30			V	$I_R=100\mu A$
Forward voltage	V_{F1}			0.24	V	$I_F=0.1mA$
				0.32	V	$I_F=1mA$
				0.40	V	$I_F=10mA$
				0.50	V	$I_F=30mA$
				1	V	$I_F=100mA$
Reverse current	I_R			2	μA	$V_R=25V$
Diode Capacitance	C_D			10	pF	$V_R=1V, f=1MHz$
Reverse Recovery Time	t_{rr}			5	ns	$I_F=I_R=10mA$ $t_{rr}=0.1X I_R, R_L=100\Omega$

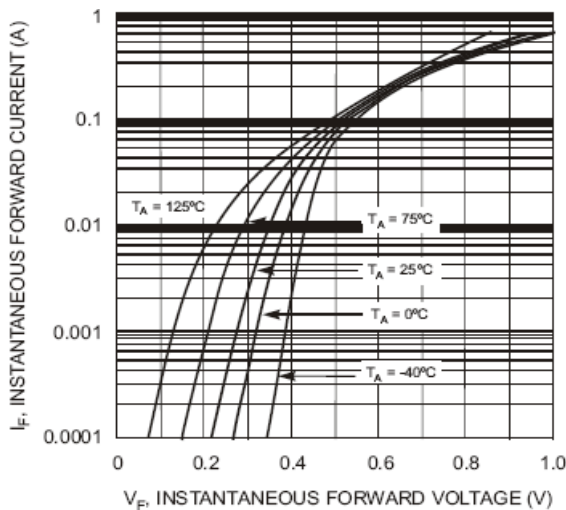
TYPICAL CHARACTERISTICS @ Ta=25°C unless otherwise specified


Fig. 1 Forward Characteristics

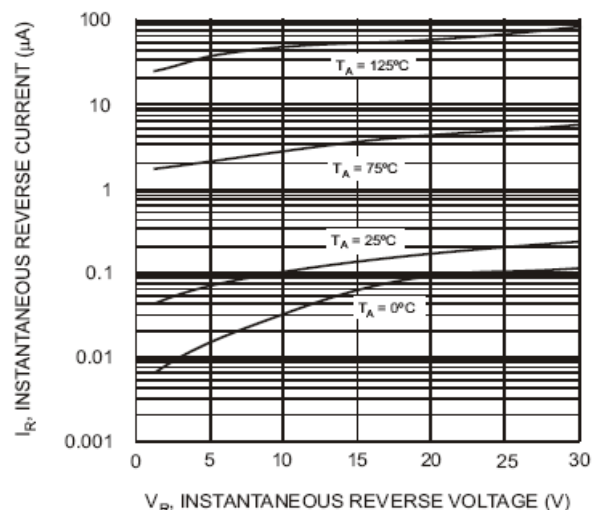


Fig. 2 Typical Reverse Characteristics

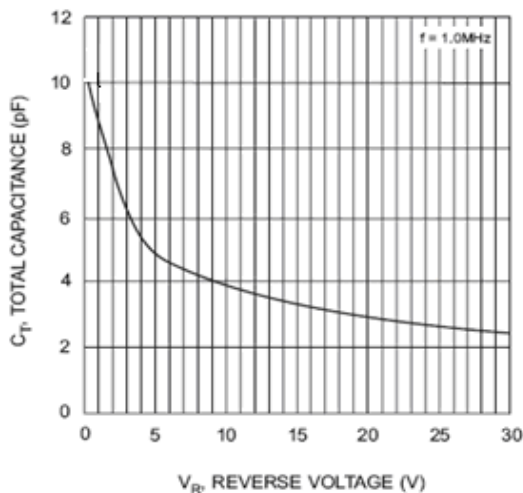


Fig. 3 Typical Capacitance vs. Reverse Voltage

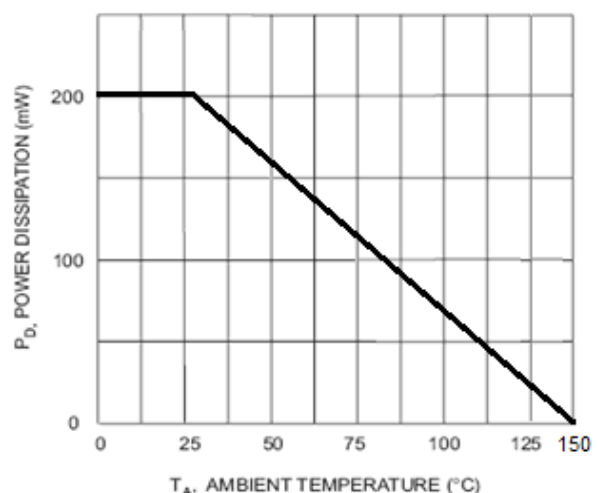


Fig. 4 Power Derating Curve

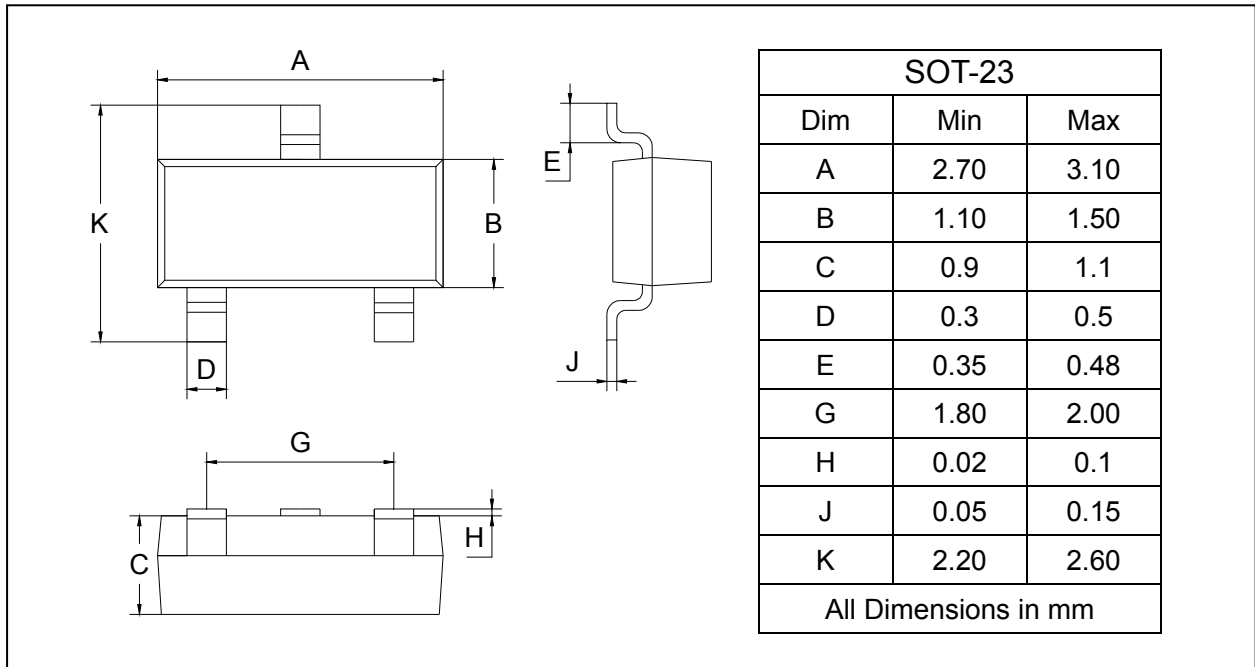


Surface Mount Schottky Barrier diode

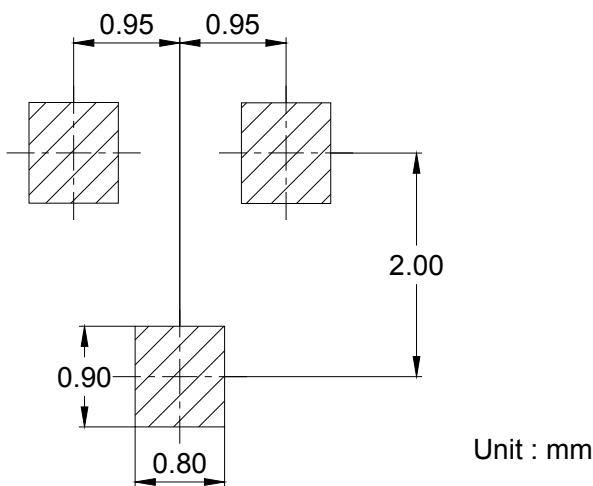
PACKAGE OUTLINE

Plastic surface mounted package

SOT-23



SOLDERING FOOTPRINT



PACKAGE INFORMATION

Device	Package	Shipping
BAT54/A/C/S	SOT-23	3000/Tape&Reel