

Features

- Ultra low capacitance: 0.5pF typical
- Ultra low leakage: nA level
- Low operating voltage: 5V
- Low clamping voltage
- 2-pin leadless package
- Complies with following standards:
 - IEC 61000-4-2 (ESD) immunity test
 - Air discharge: $\pm 25\text{kV}$
 - Contact discharge: $\pm 20\text{kV}$
 - IEC61000-4-5 (Lightning) 5A (8/20 μs)
- RoHS Compliant
- Lead Finish: NiPdAu

Applications

- Smart phones
- Display Ports
- MDDI Ports
- USB Ports
- Digital Video Interface (DVI)
- PCI Express and Serial SATA Ports

Dimensions DFN1006



Pin Configuration

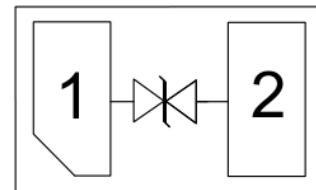

Mechanical Characteristics

- Package: DFN1006
- Lead Finish: Lead Free
- UL Flammability Classification Rating 94V-0
- Quantity Per Reel: 10,000pcs
- Reel Size: 7 inch
- Device Marking: S1

Absolute Maximum Ratings (Tamb=25°C unless otherwise specified)

Parameter	Symbol	Value	Unit
Peak Pulse Power (8/20 μs)	P _{pp}	35	W
ESD per IEC 61000-4-2 (Air)	V _{ESD}	± 25	Kv
ESD per IEC 61000-4-2 (Contact)		± 20	
Operating Temperature Range	T _J	-40 to +125	°C
Storage Temperature Range	T _{STJ}	-55 to +150	°C

Electrical Characteristics (TA=25°C unless otherwise specified)

Parameter	Symbol	Test Condition	Min	Typ	Max	Unit
Reverse Working Voltage	V _{RWM}				5.0	V
Breakdown Voltage	V _{BR}	I _T = 1mA	8.0	12.0	14.0	V
Holding Voltage	V _h	I _T = 100mA	2.6		4.0	V
Reverse Leakage Current	I _R	V _{RWM} = 5.0V			0.2	μA
Clamping Voltage	V _C	I _{PP} = 1A (8 x 20μs pulse)		5.0		V
Clamping Voltage	V _C	I _{PP} = 5A (8 x 20μs pulse)		6.0	8.0	V
Clamping Voltage	V _C	I _{PP} = 12A (TLP)		4.82		V
Clamping Voltage	V _C	I _{PP} = 16A (TLP)		7.86		V
Junction Capacitance	C _J	V _R = 0V, f = 1MHz		0.5	1.0	pF

Portion Electronics Parameter

Symbol	Parameter
I _T	Test Current
I _{PP}	Maximum Reverse Peak Pulse Current
V _C	Clamping Voltage @I _C

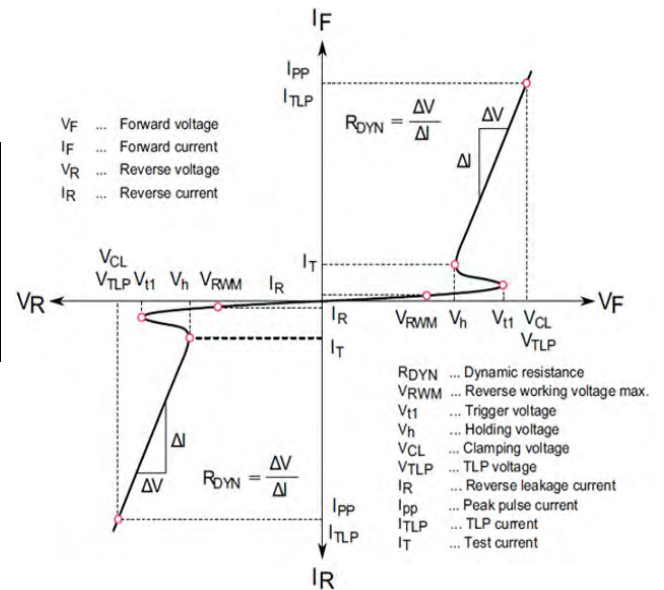

Typical Performance Characteristics ($T_A=25^\circ\text{C}$ unless otherwise Specified)

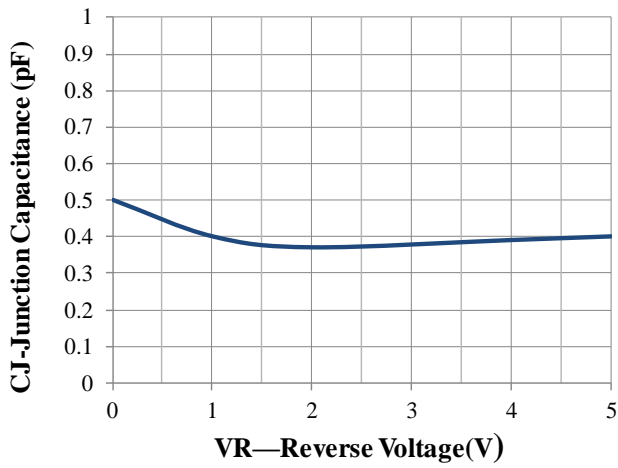

Junction Capacitance vs. Reverse Voltage

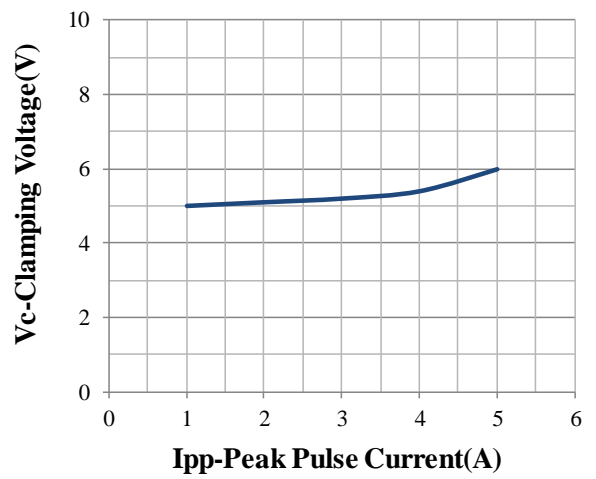

Clamping Voltage vs. Peak Pulse Current

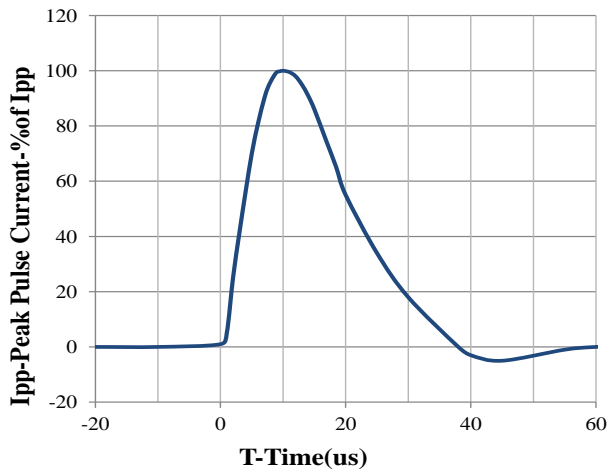

8 X 20us Pulse Waveform

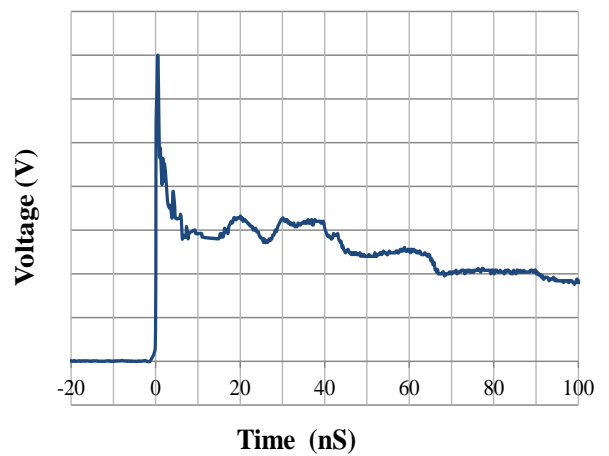

IEC61000-4-2 Pulse Waveform

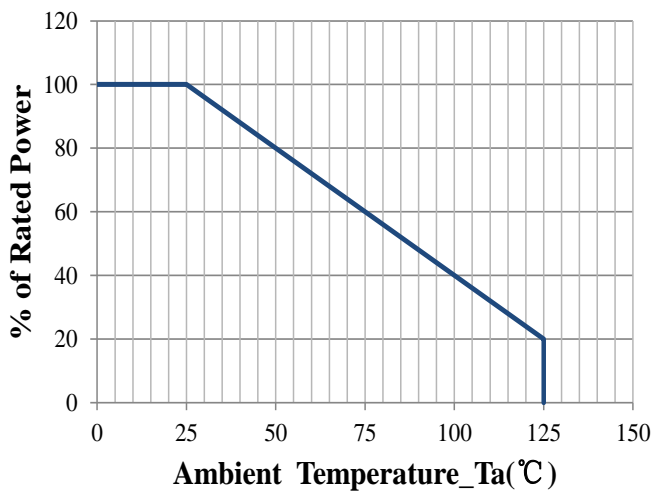

Power Derating Curve

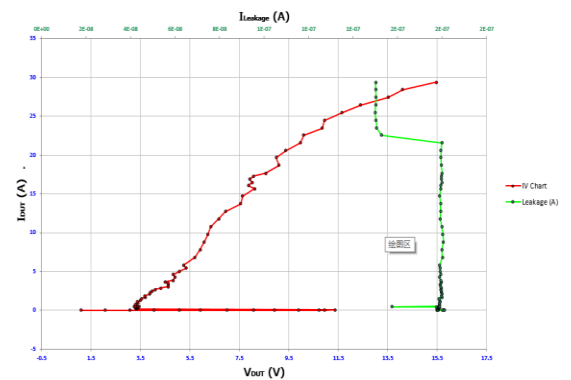

TLP Waveform

DFN1006 PACKAGE OUTLINE & DIMENSIONS

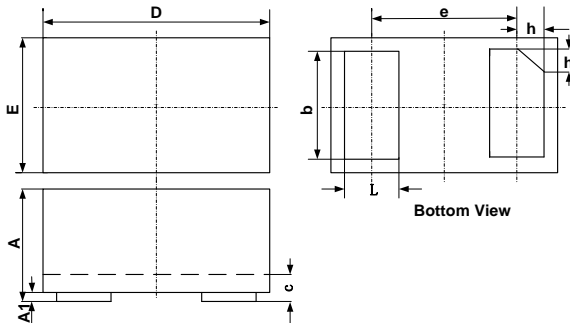

SYM	DIMENSIONS					
	MILLIMETERS			INCHES		
	MIN	NOM	MAX	MIN	NOM	MAX
A	0.40	0.50	0.55	0.018	0.020	0.022
A1	0.00	0.02	0.05	0.000	0.001	0.002
b	0.45	0.50	0.55	0.018	0.020	0.022
c	0.12	0.15	0.18	0.005	0.006	0.007
D	0.95	1.00	1.05	0.037	0.039	0.041
e	0.65 BSC			0.026 BSC		
E	0.55	0.60	0.65	0.022	0.024	0.026
L	0.20	0.25	0.30	0.008	0.010	0.012
h	0.07	0.12	0.17	0.003	0.005	0.007

Suggested Land Pattern

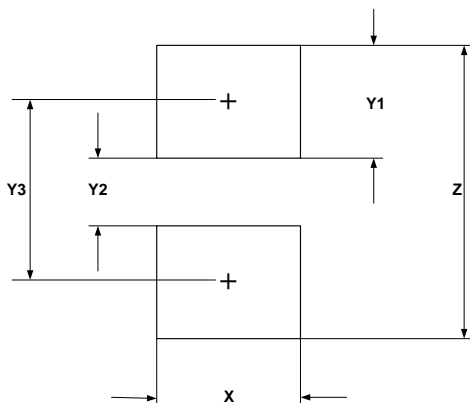

SYM	DIMENSIONS	
	MILLIMETERS	INCHES
X	0.60	0.024
Y1	0.50	0.020
Y2	0.30	0.012
Y3	0.80	0.032
Z	1.30	0.052