

Features

- 400W peak pulse power (8/20 μ s)
- Ultra low capacitance: 0.6pF typical
- Ultra low leakage: nA level
- Low operating voltage: 3.3V
- Low clamping voltage
- Protects one power line or data line
- Complies with following standards:
 - IEC 61000-4-2 (ESD) immunity test
Air discharge: ± 30 kV
Contact discharge: ± 30 kV
 - IEC61000-4-4 (EFT) 80A (5/50ns)
 - IEC61000-4-5 (Lightning) 20A (8/20)
- RoHS Compliant

Applications

- USB Ports
- Smart Phones
- Wireless Systems
- Ethernet 10/100/1000 Base T

Mechanical Characteristics

- Package: SOD-323
- Lead Finish: Matte Tin
- Case Material: “Green” Molding Compound.
- UL Flammability Classification Rating 94V-0
- Moisture Sensitivity: Level 3 per J-STD-020
- Terminal Connections: See Diagram Below
- Device Marking: CC

Dimensions SOD-323



Pin Configuration

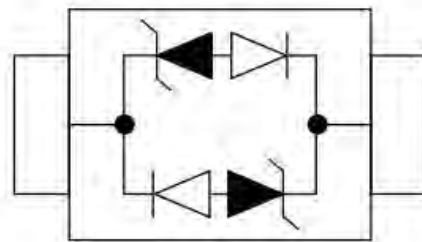

Absolute Maximum Ratings (T_{amb}=25°C unless otherwise specified)

Parameter	Symbol	Value	Unit
Peak Pulse Power (8/20 μ s)	P _{pp}	400	W
ESD per IEC 61000-4-2 (Air)	V _{ESD}	± 30	Kv
ESD per IEC 61000-4-2 (Contact)		± 30	
Operating Temperature Range	T _J	-55 to +125	°C
Storage Temperature Range	T _{STJ}	-55 to +150	°C

Electrical Characteristics($T_A=25^{\circ}\text{C}$ unless otherwise specified)

Symbol	Parameter	Conditions	Min	Typ	Max	Unit
VRWM	Reverse Working Peak Voltage				3.3	V
VBR	Reverse Breakdown Voltage	$I_T = 1\text{mA}$	4			V
IR	Reverse Leakage Current	$VRWM = 3.3\text{V}$			0.2	μA
VC	Clamping Voltage	$I_{PP} = 1 \text{ A (8/20}\mu\text{s)}$			7	V
VC	Clamping Voltage	$I_{PP} = 20 \text{ A (8/20}\mu\text{s)}$			20	V
CJ	Capacitance	$VR = 0\text{V}, f = 1\text{MHz}$		0.6		pF

Typical Performance Characteristics (TA=25°C unless otherwise Specified)

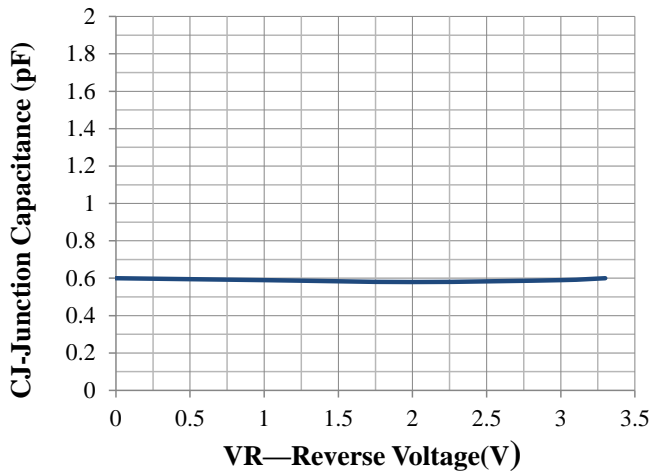

Junction Capacitance vs. Reverse Voltage

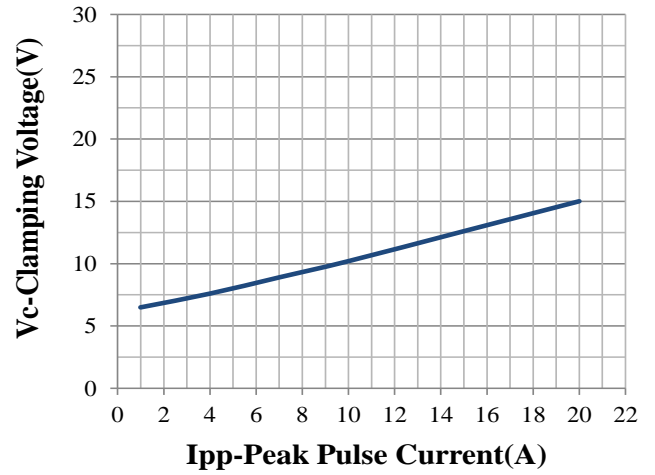

Clamping Voltage vs. Peak Pulse Current

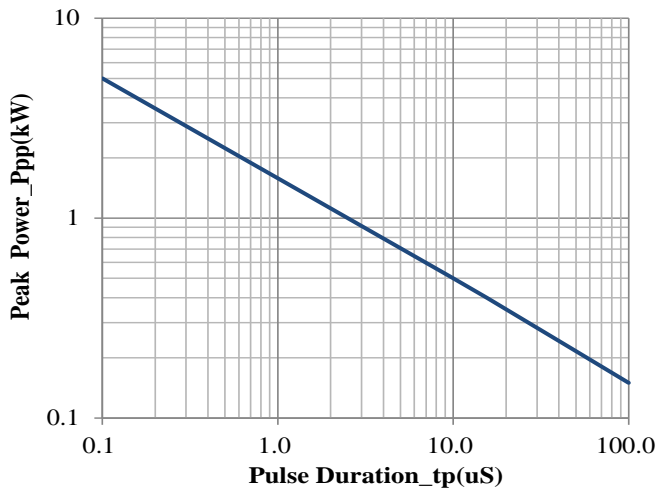

Peak Pulse Power vs. Pulse Time

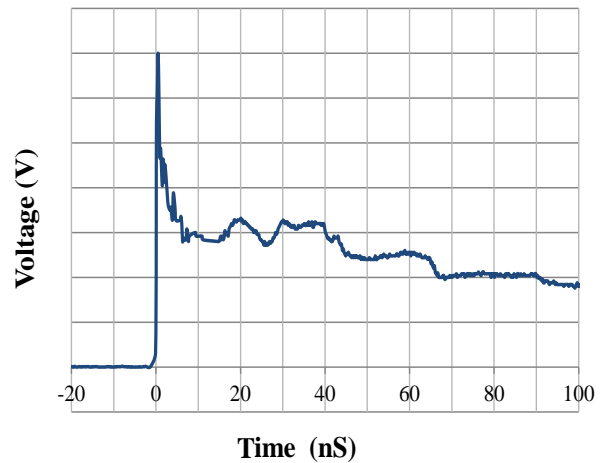

IEC61000-4-2 Pulse Waveform

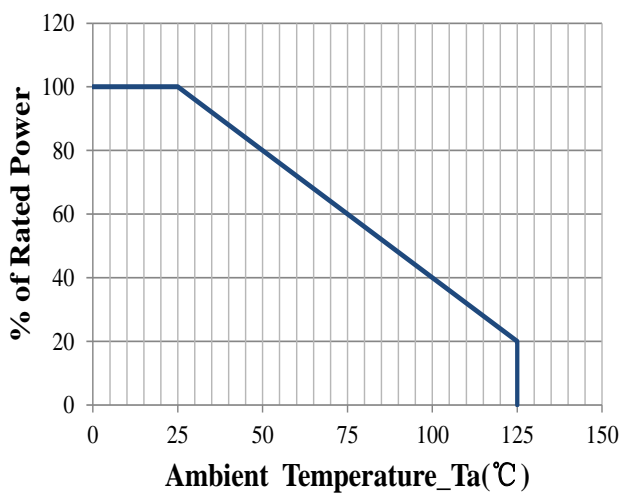

Power Derating Curve

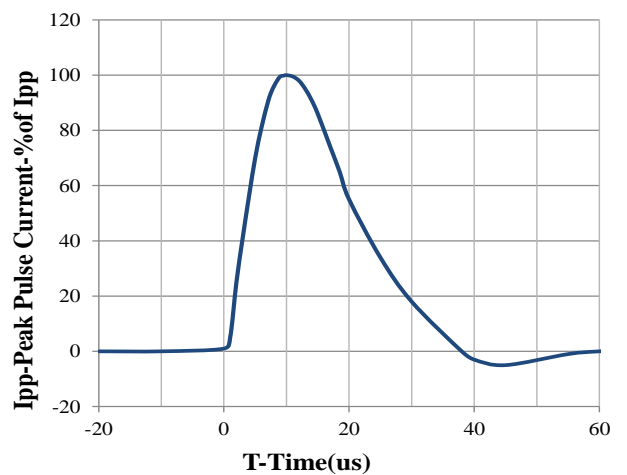

8 X 20us Pulse Waveform

SOD-323 Package Outline & Dimensions

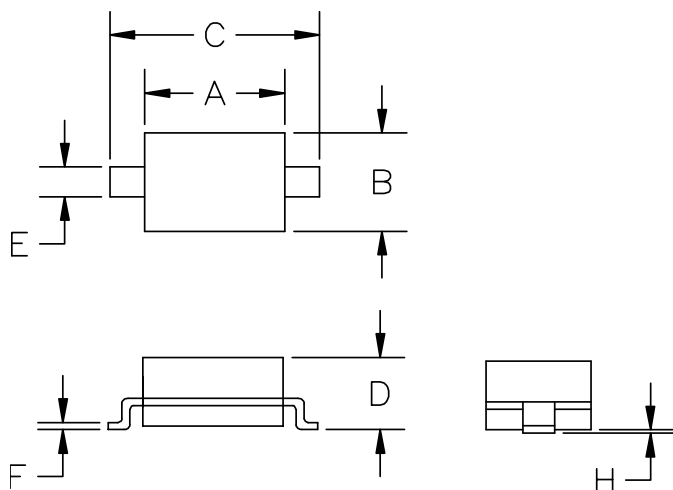

SYM	DIMENSIONS			
	MILLIMETERS		INCHES	
	MIN	MAX	MIN	MAX
A	1.50	1.80	0.060	0.071
B	1.20	1.40	0.045	0.054
C	2.30	2.70	0.090	0.107
D	-	1.10	-	0.043
E	0.30	0.40	0.012	0.016
F	0.10	0.25	0.004	0.010
H	-	0.10	-	0.004

Suggested Land Pattern

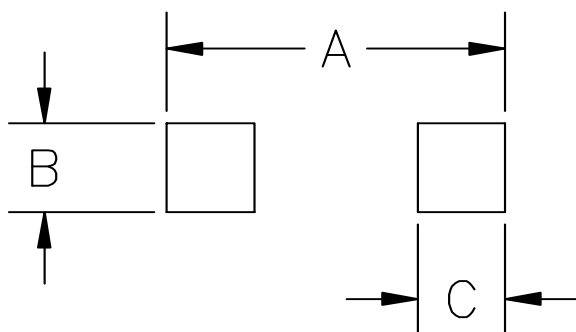

SYM	DIMENSIONS	
	MILLIMETERS	INCHES
A	3.15	0.120
B	0.80	0.031
C	0.80	0.031