



承认书

APPROVAL SHEET

客户名称:

Customer

/

产品名称:

片式负温度系数热敏电阻器

Part Name

CHIP NTC THERMISTOR

产品规格:

CMF Series

Specification

版本号:

21.01

Version No.

日期:

2021-4-6

DATE



制造 Manufacture			客户 Customer		
拟制 Draft by	审核 Checked by	确认 Approve by	检验 Check by	审核 Checked by	批准 Approval by
林晓华	徐雪枫	岑权进			



序号 No	目录 TABLE OF CONTENTS
1	外形尺寸与内部结构 Dimension & Inner-configuration
2	产品品名构成 Product Spec. Model
3	电性能参数表 Electrical Characteristics List
4	电阻-温度特性 Resistance-Temperature Characteristics
5	可靠性试验项目 Reliability Testing Items
6	产品包装 Packaging
7	环保情况说明 Environmental Protection Statement
8	推荐焊接条件 Recommend Soldering Conditions
9	清洗 Cleaning
10	存储要求 Storage Requirements
11	使用注意事项 Precautions For Use
12	注意事项 Notes



1. 外形尺寸与内部结构 Dimension & Inner-configuration:

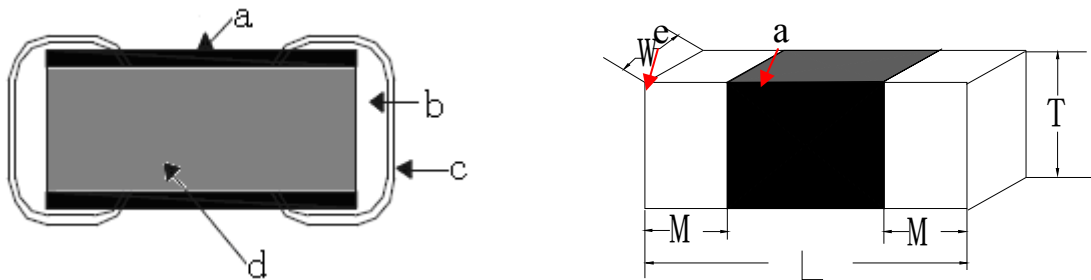

- a. 玻璃层: Gass layer
- b. 银层 Ag layer
- c. 镀层 Ni/Sn plating
- d. NTC 瓷体 NTC or ceramic
- e. 端电极 Terminal electrode

序号 No.	部位 Component		材料 Material
1	NTC瓷体 NTC or ceramic		锰钴镍 Mn-Co-Ni
2	玻璃层: Gass layer		硅铋系 Si-Bi
3	端电极 Terminal electrode	银层 Ag laye	银 Ag
		电镀层 Ni/Sn plating	镍层-锡层 Ni-Sn

单位 Unit: mm (inch)

型号 Size	L	W	T	M
0402	1.0±0.15	0.5±0.10	0.5±0.10	0.25±0.10
0603	1.6±0.15	0.75±0.15	0.75±0.15	0.30±0.15
0805	2.0±0.20	1.25±0.20	0.75±0.20	0.50±0.20
1206	3.2±0.20	1.6±0.20	0.75±0.20	0.50±0.20



2. 产品品名构成 Product Spec. Model

CMF D 103 J 3900 H A N T
① ② ③ ④ ⑤ ⑥ ⑦ ⑧ ⑨

①产品代号 Product Code		②尺寸规格 Size Code		③25℃的零功率电阻 Nominal ResistanceR25 (Ω)		④阻值公差 Tolerance of R25	
CMF	片式负温度系数热敏电阻 Chip NTC Thermistor	D	0402	102	$10 \times 10^2 = 1K \Omega$	F	±1.0%
		A	0603	103	$10 \times 10^3 = 10K \Omega$	G	±2.0%
		B	0805	104	$10 \times 10^4 = 100K \Omega$	H	±3.0%
		C	1206			J	±5.0%
⑤B值常数 B constant		⑥B值公差 Tolerance of B value		⑦B值温度代码 B value Temperature Code		⑧端电极材料 Termination Code	
3200	3200K	F	±1.0%	A	25℃/50℃	⑨包装方式 Packaging style Code	
3900	3900K	G	±2.0%	N		三层电极 Nickel Barrier	
4250	4250K	H	±3.0%			T	
						编带包装 Tape & Reel	

3. 电性能参数表 Electrical Characteristics List

型号规格 PartNumber	尺寸	零功率标称电阻 Zero Power Resistance@ 25℃		B 值 B Value	
		R ₂₅ (KΩ)	△R ₂₅ (±%)	B _{25/50} (k)	△B _{25/50} (±%)
CMFD103□3900HANT	1005	10	1、2、3、5、 10	3900	1、2、3
CMFD473□3950HANT		47		3950	
CMFD503□3950HANT		50		3950	
CMFD683□3950HANT		68		3950	
CMFD104□3900HANT		100		3900	
CMFD154□4100HANT		150		4100	
CMFD224□3950HANT		220		3950	
CMFD334□4050HANT		330		4050	
CMFD474□4050HANT		470		4050	
CMFD684□4200HANT		680		4200	



型号规格 PartNumber	尺寸	零功率标称电阻 Zero Power Resistance@ 25°C		B 值 B Value	
		R ₂₅ (KΩ)	ΔR ₂₅ (±%)	B _{25/50} (k)	ΔB _{25/50} (±%)
CMFA102□3200HANT	1608	1.0	1、2、3、5、 10	3200	1、2、3
CMFA202□3400HANT		2.0		3400	
CMFA222□3450HANT		2.2		3450	
CMFA332□3380HANT		3.3		3380	
CMFA472□3450HANT		4.7		3450	3
CMFA472□3950HANT		4.7		3950	1、2、3
CMFA502□3450HANT		5.0		3450	3
CMFA502□3950HANT		5.0		3950	1、2、3
CMFA682□3950HANT		6.8		3950	
CMFA103□3500HANT		10		3500	
CMFA103□3600HANT		10		3600	
CMFA153□3950HANT		15		3950	
CMFA223□3300HANT		22		3300	
CMFA303□3950HANT		30		3950	
CMFA333□3950HANT		33		3950	
CMFA473□3950HANT		47		3950	
CMFA503□3950HANT		50		3950	
CMFA683□3950HANT		68		3950	
CMFA104□3950HANT		100		3950	
CMFA154□3950HANT		150		3950	
CMFA204□4050HANT		200		4050	
CMFA224□4050HANT		220		4050	
CMFA334□4050HANT		330		4050	
CMFA474□4200HANT		470		4200	
CMFA564□4200HANT		560		4200	
CMFA684□4200HANT		680		4200	



型号规格 PartNumber	尺寸	零功率标称电阻 Zero Power Resistance@ 25°C		B 值 B Value	
		R ₂₅ (KΩ)	ΔR ₂₅ (±%)	B _{25/50} (k)	ΔB _{25/50} (±%)
		CMFB801□3200HANT	2012	0.8	1、2、3、5、 10
CMFB102□3200HANT	1.0	3200			
CMFB202□3400HANT	2.0	3400			
CMFB222□3450HANT	2.2	3450			
CMFB332□3400HANT	3.3	3400			
CMFB472□3450HANT	4.7	3450		3	
CMFB472□3950HANT	4.7	3950		1、2、3	
CMFB502□3450HANT	5.0	3450		3	
CMFB502□3950HANT	5.0	3950		1、2、3	
CMFB682□3950HANT	6.8	3950			
CMFB103□3500HANT	10	3500			
CMFB103□3600HANT	10	3600			
CMFB103□3950HANT	10	3950			
CMFB123□3500HANT	12	3500			
CMFB223□3950HANT	22	3950			
CMFB303□3950HANT	30	3950			
CMFB333□3950HANT	33	3950			
CMFB473□3950HANT	47	3950			
CMFB503□3950HANT	50	3950			
CMFB683□3950HANT	68	3950			
CMFB104□3950HANT	100	3950			
CMFB124□3950HANT	120	3950			
CMFB154□3950HANT	150	3950			
CMFB204□4050HANT	200	4050			
CMFB224□4050HANT	220	4050			
CMFB304□4150HANT	300	4150			
CMFB334□4150HANT	330	4150			
CMFB474□4150HANT	470	4150			
CMFB564□4150HANT	560	4150			
CMFB684□4200HANT	680	4200			



型号规格 PartNumber	尺寸.	零功率标称电阻 Zero Power Resistance@ 25°C		B 值 B Value	
		R ₂₅ (KΩ)	ΔR ₂₅ (±%)	B _{25/50} (k)	ΔB _{25/50} (±%)
CMFC472□3450HANT	3216	4.7	1、2、3、5、 10	3450	3
CMFC472□3900HANT		4.7		3900	1、2、3
CMFC502□3450HANT		5.0		3450	3
CMFC502□3900HANT		5.0		3900	1、2、3
CMFC682□3900HANT		6.8		3900	
CMFC103□3600HANT		10		3600	
CMFC103□3950HANT		10		3950	
CMFC223□3950HANT		22		3950	
CMFC333□3950HANT		33		3950	
CMFC473□3950HANT		47		3950	
CMFC503□3950HANT		50		3950	
CMFC683□3950HANT		68		3950	
CMFC104□3950HANT		100		3950	
CMFC154□3950HANT		150		3950	
CMFC224□4050HANT		220		4050	
CMFC334□4050HANT		340		4050	
CMFC474□4200HANT		470		4200	
CMFC564□4200HANT		560		4200	
CMFC684□4200HANT		680		4200	



4. 电阻-温度特性 Resistance-Temperature Characteristics

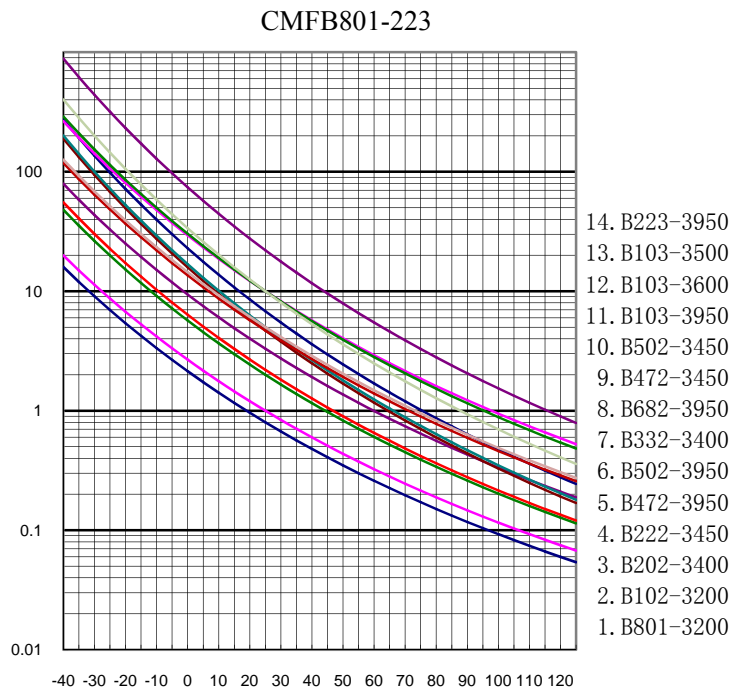
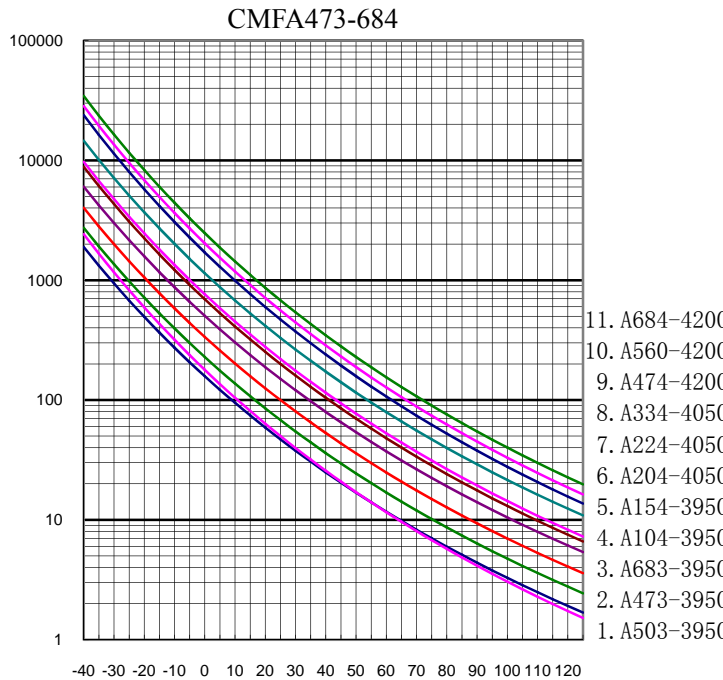
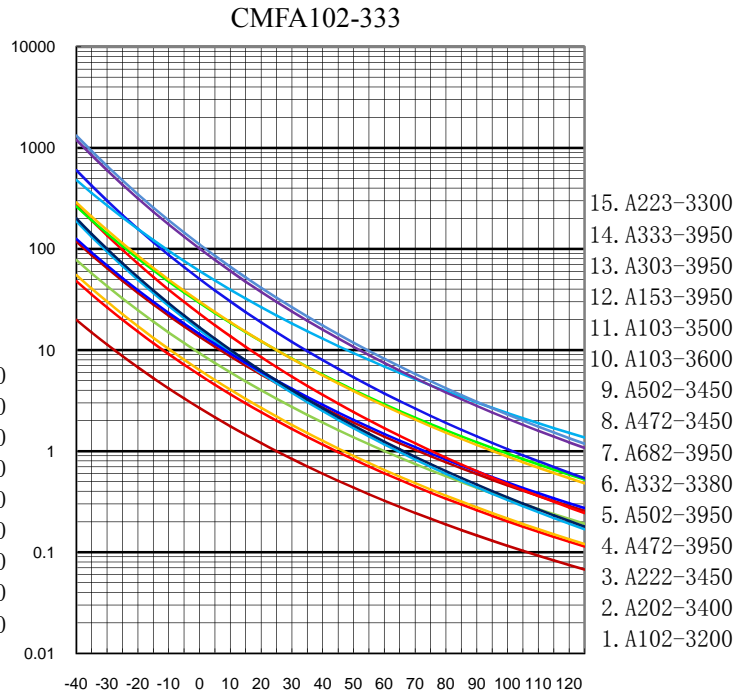
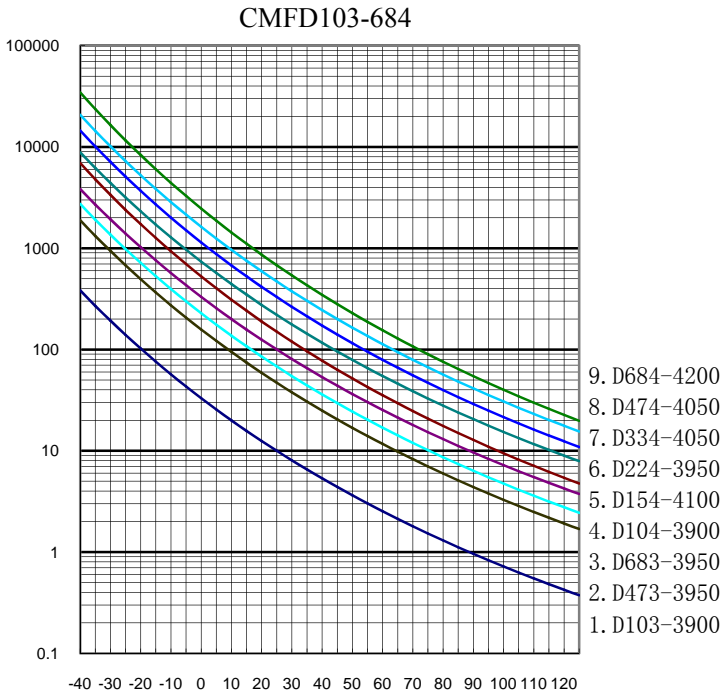



CMFB303-684

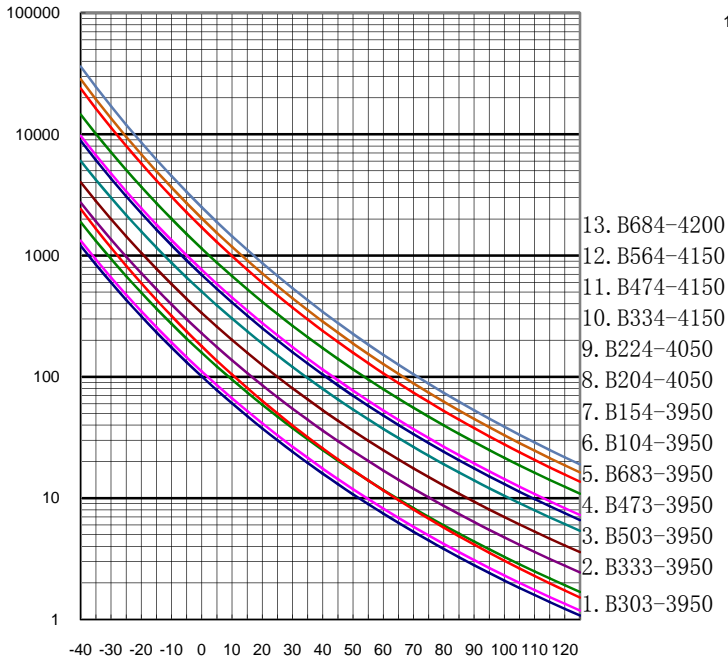

CMFC472-333

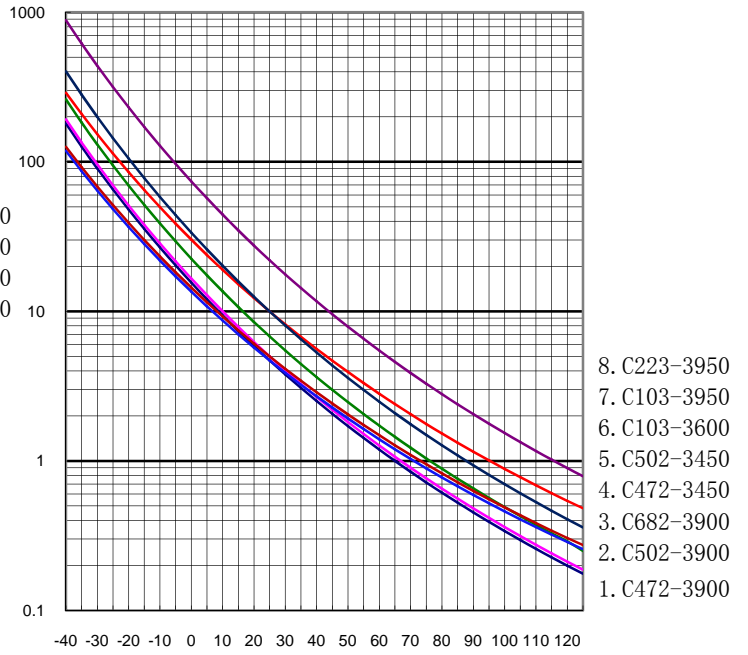

CMFC473-68

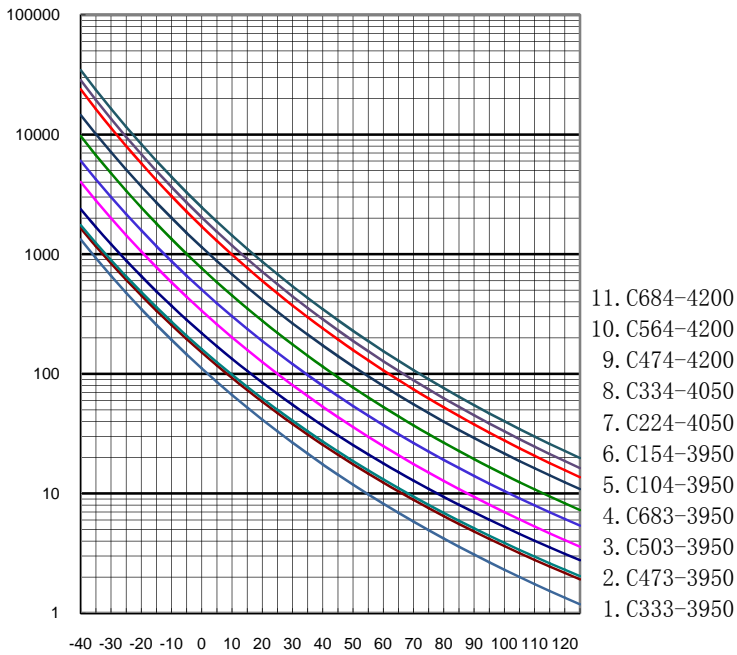



5. 可靠性试验项目 Reliability Testing Items

序号 No.	项目 Items	要求 Requirements	试验方法及备注 Test Methods and Remarks
1	工作温度范围 Operating Temperature Range	-40°C~+125°C	
2	可焊 Solder ability	至少 95%端电极表面被焊锡覆盖。 At least 95% of terminal electrode should be covered with solder	预热温度:120°C~150°C 预热时间: 60s 焊料: (96.5%Sn/3.0%Ag/0.5%Cu) 焊 锡 焊锡温度: 245°C±5°C 浸锡深度:10mm 浸锡时间 : 5±1s 浸渍到助焊剂约:3~5 s Preheating temperature:120°C to 150°C Preheating time: 60s Solder 96.5%Sn/3.0%Ag/0.5%Cu of the Sn solder. Solder temperature: 245±5°C Immersion tin depth:10mm Duration : 5±1s Dip performance to a flux of about:3~5 s
3	耐焊接热 Resistance to Soldering	无可见机械损伤; R25 变化率小于±5%; B 值变化率小于±2% No mechanical damage. R25 change shall be less than±5%; B-constant change shall be less than ±2%.	预热温度: 120°C~150°C 预热时间: 60s 焊料: (96.5%Sn/3.0%Ag/0.5%Cu) 焊 锡 浸锡温度: 260°C±5°C 浸锡深度:10mm 浸锡时间 : 10±1s 浸渍到助焊剂约:3 ~ 5 s Preheating temperature: 120°C to 150°C Preheating time: 60s Solder 96.5%Sn/3.0%Ag/0.5%Cu of the Sn solder. Solder temperature: 260°C±5°C Immersion tin depth:10mm Duration : 10±1s Dip performance to a flux of about:3 ~ 5 s

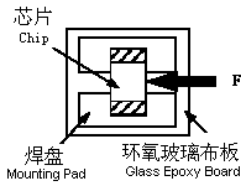
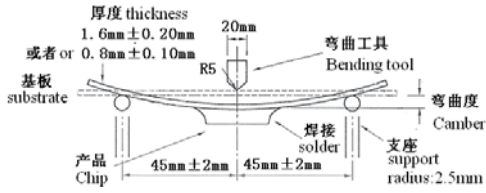

序号 No.	项目 Items	要求 Requirements	试验方法及备注 Test Methods and Remarks															
4	端电极强度 Adhesion of electrode	端电极与瓷体不应受损, 无可见机械损伤。 The termination and body should be no damage.	 <table border="1" data-bbox="1007 546 1366 757"> <thead> <tr> <th>类型 Type</th> <th>推力(N) Force (N)</th> <th>时间(s) Time (s)</th> </tr> </thead> <tbody> <tr> <td>0402</td> <td>4</td> <td>10±1</td> </tr> <tr> <td>0603</td> <td>5</td> <td>10±1</td> </tr> <tr> <td>0805</td> <td>6</td> <td>10±1</td> </tr> <tr> <td>1206</td> <td>10</td> <td>10±1</td> </tr> </tbody> </table>	类型 Type	推力(N) Force (N)	时间(s) Time (s)	0402	4	10±1	0603	5	10±1	0805	6	10±1	1206	10	10±1
类型 Type	推力(N) Force (N)	时间(s) Time (s)																
0402	4	10±1																
0603	5	10±1																
0805	6	10±1																
1206	10	10±1																
5	振动 Vibration	无可见机械损伤; R25 变化率小于±5%; B 值变化率小于±2% No mechanical damage. R25 change shall be less than±5%; B-constant change shall be less than ±2%.	振动频率范围: 10Hz~55Hz~10Hz 全振幅: 1.50mm 时间: X/Y/Z 轴各 2h Frequency: 10Hz~55Hz~10Hz Amplitude: 1.50mm Time: Vibrated for a period of 2h, in three directions perpendicularly intersecting each other.															
6	抗弯强度 Resistance to flexure	无可见机械损伤; R25 变化率小于±5%; B 值变化率小于±2% No mechanical damage. R25 change shall be less than±5%; B-constant change shall be less than ±2%.	条件: 测试基板(PCB) 施压速度: 0.5mm/s Condition: print circuit board. Pressing speed: 0.5 mm/s  <table border="1" data-bbox="970 1541 1401 1749"> <thead> <tr> <th>规格 Size code</th> <th>弯曲度 Camber (mm)</th> <th>保持时间 Duration (s)</th> </tr> </thead> <tbody> <tr> <td>0402、0603</td> <td>0.7</td> <td>30</td> </tr> <tr> <td>0805、1206</td> <td>1.0</td> <td>30</td> </tr> </tbody> </table>	规格 Size code	弯曲度 Camber (mm)	保持时间 Duration (s)	0402、0603	0.7	30	0805、1206	1.0	30						
规格 Size code	弯曲度 Camber (mm)	保持时间 Duration (s)																
0402、0603	0.7	30																
0805、1206	1.0	30																
7	耐高温 High temperature resistance	无可见机械损伤; R25 变化率小于±5%; B 值变化率小于±2% No mechanical damage. R25 change shall be less than±5%; B-constant change shall be less than ±2%.	测试时间: 1000 ⁺²⁴ ₋₀ h 测试温度: 125±2℃ Testing time: 1000 ⁺²⁴ ₋₀ h Temperature: 125±2℃															



序号 No.	项目 Items	要求 Requirements	试验方法及备注 Test Methods and Remarks															
8	耐低温 Low temperature resistance	无可见机械损伤; R25 变化率小于 $\pm 5\%$; B 值变化率小于 $\pm 2\%$ No mechanical damage. R25 change shall be less than $\pm 5\%$; B-constant change shall be less than $\pm 2\%$.	测试温度: $-40\pm 2^{\circ}\text{C}$ $+24$ 测试时间: $1000 - 0$ h Temperature: $-40\pm 2^{\circ}\text{C}$ $+24$ Testing time: $1000 - 0$ h															
9	恒定湿热 Static Humidity	无可见机械损伤; R25 变化率小于 $\pm 5\%$; B 值变化率小于 $\pm 2\%$ No mechanical damage. R25 change shall be less than $\pm 5\%$; B-constant change shall be less than $\pm 2\%$.	湿度: $90\% \sim 95\% \text{ RH}$, 温度: $60^{\circ}\text{C} \pm 2^{\circ}\text{C}$ 测试时间: $1000 - 0^{+24}$ h Humidity: 90% to 95% RH Temperature: $60^{\circ}\text{C} \pm 2^{\circ}\text{C}$ Testing time: $1000 - 0^{+24}$ h															
10	温度冲击 Temperature Shock	无可见机械损伤; R25 变化率小于 $\pm 5\%$; B 值变化率小于 $\pm 2\%$ No mechanical damage. R25 change shall be less than $\pm 5\%$; B-constant change shall be less than $\pm 2\%$.	无负荷,在下列条件循环 32 次 cycles without load <table border="1"> <thead> <tr> <th>阶段 Step</th> <th>温度 Temp.</th> <th>时间 Time (Min.)</th> </tr> </thead> <tbody> <tr> <td>1</td> <td>-40°C</td> <td>30 ± 3</td> </tr> <tr> <td>2</td> <td>室温/Room Temp</td> <td>5 ± 3</td> </tr> <tr> <td>3</td> <td>$+125^{\circ}\text{C}$</td> <td>30 ± 3</td> </tr> <tr> <td>4</td> <td>室温/Room Temp</td> <td>5 ± 3</td> </tr> </tbody> </table>	阶段 Step	温度 Temp.	时间 Time (Min.)	1	-40°C	30 ± 3	2	室温/Room Temp	5 ± 3	3	$+125^{\circ}\text{C}$	30 ± 3	4	室温/Room Temp	5 ± 3
阶段 Step	温度 Temp.	时间 Time (Min.)																
1	-40°C	30 ± 3																
2	室温/Room Temp	5 ± 3																
3	$+125^{\circ}\text{C}$	30 ± 3																
4	室温/Room Temp	5 ± 3																

6. 产品包装 Packaging

6.1 编带图 Taping drawings

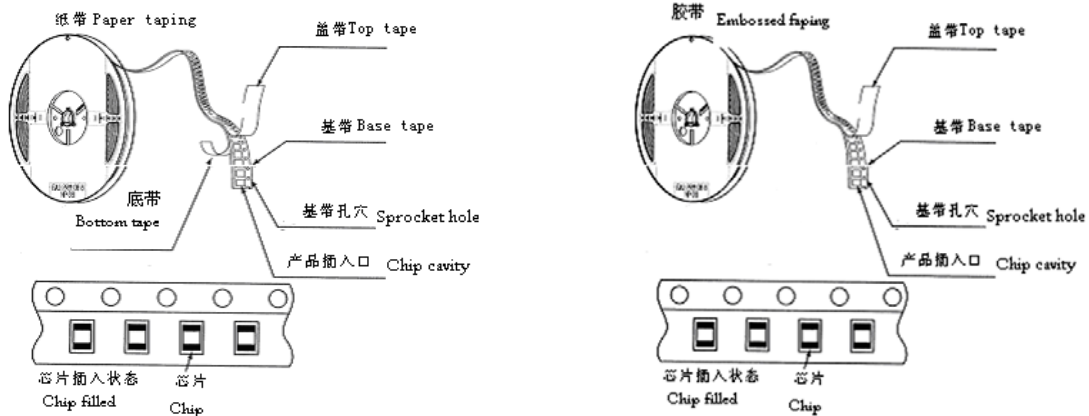



6.2 卷盘尺寸 Reel dimensions (Unit:mm)

型号 Size	A	B	C	N	G
CF-8	178 ±2.0	22.0 ±2.0	12.5 ±1.5	57 ±2.0	8

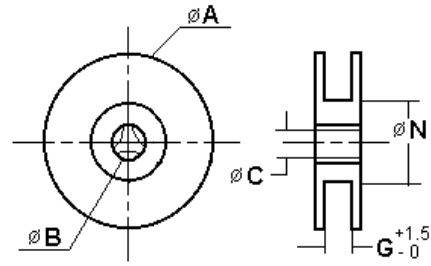

6.3 导带及空格部分 Leader and blank portion

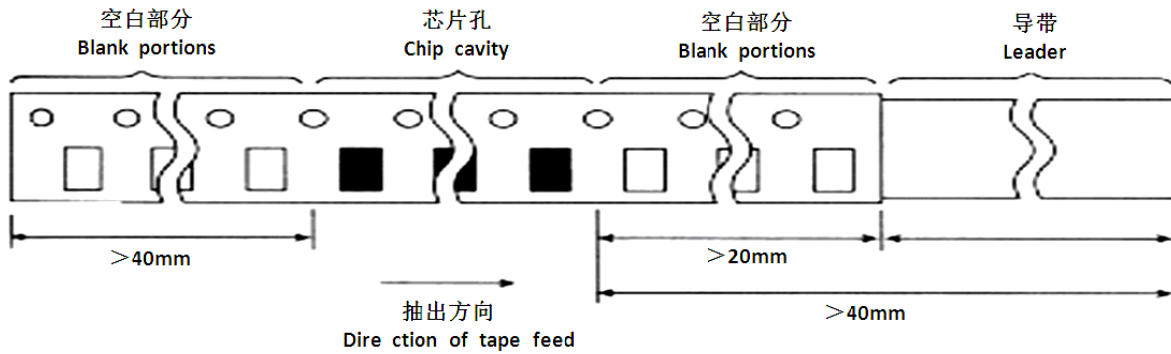

6.4 编带尺寸 Taping dimensions (Unit: mm)

●纸带 Paper tape

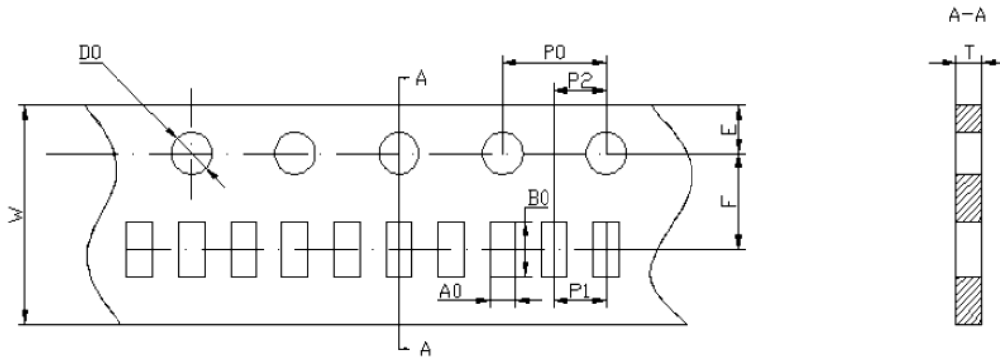

型号 Size	A0	B0	W	F	E	P1	P2	P0	D0	T
0402	0.65±0.1	1.15±0.1	8.0±0.2	3.5±0.1	1.75±0.2	2.0±0.1	2.0±0.1	4.0±0.2	1.55±0.1	0.60±0.1
0603	1.10±0.2	1.90±0.2	8.0±0.2	3.5±0.1	1.75±0.2	4.0±0.2	2.0±0.1	4.0±0.2	1.55±0.1	0.95±0.1
0805	1.50±0.2	2.30±0.2	8.0±0.2	3.5±0.1	1.75±0.2	4.0±0.2	2.0±0.1	4.0±0.2	1.55±0.1	0.95±0.1
1206	1.90±0.2	3.50±0.2	8.0±0.2	3.5±0.1	1.75±0.2	4.0±0.2	2.0±0.1	4.0±0.2	1.55±0.1	0.95±0.1



●塑料胶带 Embossed tape

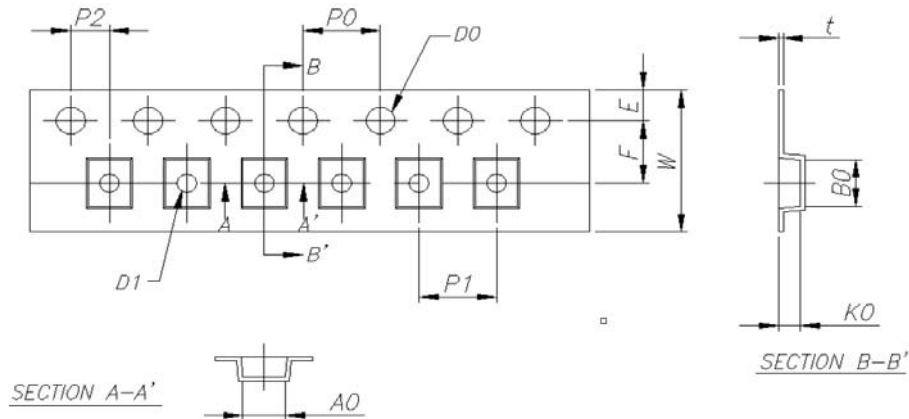

型号 Size	A ₀	B ₀	K ₀	W	E	F
1206	1.88+/-0.10	3.50+/-0.10	1.27+/-0.10	8.00+/-0.20	1.75+/-0.10	3.50+/-0.10
	D ₀	D ₁	P ₀	P ₁	P ₂	t
	1.50+/-0.10	1.00+/-0.10	4.00+/-0.10	4.00+/-0.10	2.0+/-0.05	0.23+/-0.20

6.5 剥离力检验 Peeling off force

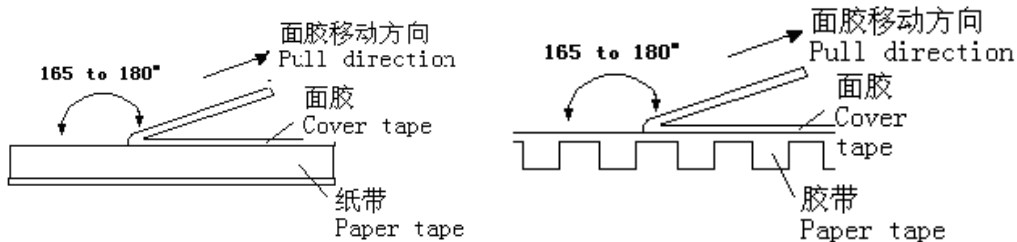

(1) 盖带的剥离力：沿面胶移动方向拉时要求剥离力为 0.1N~0.7N。

Peeling force should be 0.1~0.7N pulling in the direction of arrow.

(2) 剥离速度：300mm/min

Speed of peeling off: 300mm/min.

(3) 在胶带、纸带剥落时，面胶不能有破损，不能粘纸带。

The cover bond should not be damaged and bond the tape when it peeled off.

6.6 包装数量（单位：粒） Packaging number (Unit: Pcs)

型号 Size	1206		0805	0603	0402
每卷数量 REEL	3000	4000	4000	4000	10000
每盒数量 BOX	30000	40000	40000	40000	100000
每箱数量 CASE	180000	240000	240000	240000	600000



6.7 标签粘贴位置 Label stick station

卷盘标签 Reel label	纸盒标签 Carton label	纸盒标签 Carton label	外箱标签 Outer box label
			

7. 环保情况说明 Environmental Protection Statement

RoHS 指令： 公司产品符合 RoHS 指令。

Response to RoHS directive: Our products are RoHS compliance.

8. 推荐焊接工艺 Recommended Soldering Technologies

8.1 回流焊 Re-flowing Profile

8.1.1 预热不足有可能引发产品表面裂纹，从而导致产品品质下降。预热温度与最高温度之间的差值应 $\leq 100^{\circ}\text{C}$ 。

Un-enough pre-heating may cause cracks on the ferrite, resulting in the deterioration of product quality. The difference between the preheating temperature and the maximum temperature should be less than 100°C

8.1.2 不建议将元件浸泡溶剂或使用其他方法来快速冷却元件。

Rapid cooling by dipping in solvent or by other means is not recommended.

8.1.3 回流焊接条件 Reflow Soldering Conditions

- 预热条件: $150 \sim 200^{\circ}\text{C} / 60 \sim 120$ 秒
Preheat condition: $150 \sim 200^{\circ}\text{C} / 60 \sim 120$ sec
- 允许大于 217°C 时间: $60 \sim 90$ 秒
Allowed time above 217°C : $60 \sim 90$ sec
- 最大温度: 260°C
max temp: 260°C
- 最高温的最大时间: 10秒
max time at max temp: 10 sec
- 焊膏: Sn/3.0Ag/0.5Cu
Solder paste: Sn/3.0Ag/0.5Cu
- 回流焊次数: 最多2次
Allowed Reflow time: 2x max

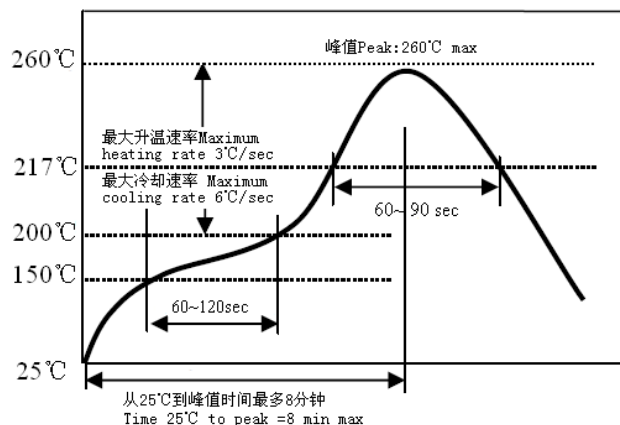

注意：上表中回流焊曲线仅谨作参考，并非为指定的回流焊工艺。实际的电路板组装置必须根据客户具体的电路板设计、焊膏和工艺，并且不应超过以上回流焊曲线参数。

Note: The reflow profile in the above table is for reference only and is not the specified reflow process. Actual board assembly configuration must be based on the customer's specific board design, solder paste and process, and should not exceed the parameters as the reflow profile shows.



8.2 手工焊接 Iron soldering

8.2.1 烙铁温度: 350°C (Max)

Soldering Tip temperature: 350°C Max.

8.2.2 烙铁功率: 最大为 30W

Iron soldering power: Max.30W

8.2.3 烙铁头直径: Φ3mm (max.)

Diameter of Soldering Iron-tip:Φ3mm (max.)

8.2.4 烙铁停留时间: <3S (注意不要将烙铁碰到产品端电极)。

Soldering Time: <3S (Take care not to apply the tip of the soldering iron to the terminal electrodes)。

8.2.5 手工焊接: 最多 1 次

Max.1 times for iron soldering

注意:

常规情况下不建议用烙铁焊接, 如用烙铁焊接需注意烙铁头的温度管理和焊接工艺控制。烙铁温度急剧变化所产生的压力将直接作用在热敏电阻上, 骤热或骤冷、两端焊锡不均匀、产品高低不平等都会使热敏电阻内部产生较大的热应力, 将引发热裂纹。因此用烙铁焊接时需慎重评估相关条件及方法。

Note: In normal circumstances, soldering with soldering iron is not recommended. If welding with soldering iron, please pay attention to the temperature of the soldering iron head and welding process control. The pressure caused by sharp temperature change of soldering iron will act directly on the thermistor. Sudden heat or cold, uneven solder at both ends, uneven product will cause big thermal stress in the thermistor, which will cause hot cracks. Therefore, it is necessary to evaluate the relevant conditions and methods carefully when welding with soldering iron.

建议采用热风方法进行维修。

hot air methods are recommended for repair purposes.

用烙铁焊接过一次并拆卸后的产品不可使用。

Once the product is welded with soldering iron and disassembled, it can't be used .

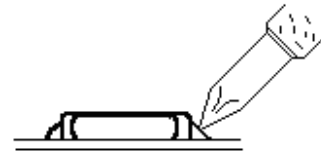

9.清洗 Cleaning

9.1 清洗条件 Cleaning Conditions

清洗温度: 60°C (最高) Cleaning temperature : 60°C max

清洗时间: 1 分钟 (最少) Cleaning time: 1 minute min.

超声波功率最大为 200W: Ultrasonic output power: 200Wmax

进行超声波清洗时, 请防止安装部分与基板发生共振。Please keep mounted parts and a substrate from an occurrence of resonance in ultrasonic cleaning.

10. 存储要求 Storage Requirements

10.1 存储期限 Storage period

距电感公司出厂检验时间 6 个月内, 产品可以使用检验时间可以通过包装外侧标记的检验号确认。若时间超过 6 个月, 应检查焊接性能后方可使用。

Products which inspected in INDUCTOR COMPANY over 6 months ago should be examined and used, which can be Confirmed with inspection No. marked on the container. Solder ability should be checked if this period is exceeded.

10.2 存储条件 Storage conditions

(1) 存放货物的库房应满足以下条件: 温度: -10 ~ +40°C, 相对湿度: 30 ~ 70%。

Products should be storage in the warehouse on the following conditions:



Temperature : -10~+40°C Humidity: 30~70% relative humidity

(2) 禁止将产品保管在腐蚀性物质中，如硫磺、氯气或酸，否则将引起端头氧化，导致降低焊接性。

Don't keep products in corrosive gases such as sulfur, chlorine gas or acid , or it may case oxidization of Electrodes resulting in poor solder ability.

(3) 为了避免受潮气、灰尘等物质的影响，产品应保管于货架上。

Products should be stored on the palette for the prevention of the influence from humidity, dust and so on.

(4) 产品保管在库房中，应避免热冲击、振动以及直接光照等等。

Products should be stored in the warehouse without heat shock, vibration, direct sunlight and so on.

(5) 产品应密封包装。

Products should be stored under the airtight packaged condition.

11.使用注意事项 Precautions For Use

11.1 操作注意事项 Operating Considerations

本产品的陶瓷元件为易碎材料制成，使用时务必小心不要施加过大压力或引起冲击。此类强力可能会造成产品破裂或破碎。

The ceramic of this product is fragile, and care must be taken not to load an excessive press - force or to give a shock at handling. Such forces may cause cracking or chipping.

11.2 PC 板的设计 PCB design

(1) 当片式NTCR被安装在PC板上后，所使用的焊料的量（焊盘的大小）会直接影响到片式NTCR的性能，因此在设计基板时，必须慎重考虑焊盘的大小和配置，这些对组成基板的焊料的量有着决定的作用，过量的焊料会影响到芯片耐机械应力的能力。

When chip thermistors are mounted on a PCB, the amount of solder used (size of fillet) can directly affect thermistor performance. Therefore, when design land- patterns it is necessary to consider the appropriate size and configuration of the solder pads, which determines the amount of solder necessary to form the fillets. Excess solder can affect the ability of chips to withstand mechanical stress.

(2) 推荐最大焊盘尺寸 Recommended maximum dimensions (mm)

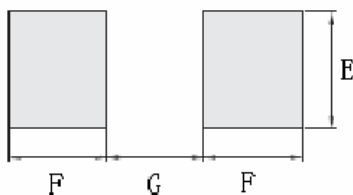

型号 Size	E	F	G
1005	0.60	0.60	0.50
1608	1.00	1.00	1.00
2012	1.40	1.20	1.00
3216	1.80	1.20	2.00

(3) 基板配置：将片式 NTCR 安装在板上之后，芯片将承受在下一加工过程中产生的机械应力，出于这个原因，在设计焊盘和片式 NTCR 的位置时，应注意考虑将应力减少到最低点。

Pattern configurations: After chip thermistor have been mounted on the board, chips can be subject to mechanical stresses in subsequent manufacturing process , for this reason, planning pattern configurations and the position of SMD thermistors should be carefully performed to minimize stress.

11.3 自动安装应考虑到的问题 Considerations for automatic placement.

(1) 在将片式 NTCR 安装在 PC 板上时，不能让其承受过量的冲击力。



Excessive impact load should not be imposed on the thermistor when mounting on the PCB .

(2) 应定期对安装机器进行维护和检查。

The maintenance and inspection of the mounting devices should be conducted periodically .

(3) 当 PC 板沿着接缝孔切割开时，片式 NTCR 所受机械应力的的大小因使用的方法不同而不同。以下方法按应力从小到大进行排列：推板、割裂、V 形凹槽、接缝孔。因此。任何理想的片式 NTCR 的布局必须考虑到 PC 板的分割方法。

When beating PCB along their perforations, the amount of mechanical stress on the thermistor can vary according to the method used .The following methods are listed in order from least stressful to most stressful: push-back, slit, v-grooving, and perforation. Thus, any ideal SMD thermistor layout must also consider the PCB splitting procedure.

11.4 焊膏的印刷 printing solder paste

(1) 焊膏的印刷厚度建议在 150 μ m~200 μ m。

Recommendable thickness of solder paste printing should from 150 μ m to 200 μ m.

(2) 焊接后，爬锡高度为 0.2mm 至本产品的厚度。

After soldering, the solder fillet shall be a height from 0.2mm to the thickness of chip thermistor.

(3) 过多的焊料将给本产品过大的机械应力，这些应力将导致断裂或机械损伤，也可能破坏产品的电性能。

Too much solder gives too strong mechanical stress to chip thermistor, such stress may cause cracking or any mechanical damage. And also, it can destroy the electrical performance of this product.

12. 注意事项 Notes

12.1 若本次承认的为“整体无铅”产品，则表明该产品符合RoHS指令的要求。

If the parcel label on product is "Unitary lead free" that indicate the products in accord with ROHS appointed requests.

12.2 本承认书保证我司产品作为一个单体时的质量情况，当我司产品被安装到贵司产品上时请保证贵司的产品已根据贵司的规范进行了有效评价和确认。

This product specification guarantees the quality of our product as a single unit, Please make sure that your product has been evaluated and confirmed against your specifications when our product is mounted to your product.

12.3 如果贵司对我司产品的试用已超过了本测试规范所界定的产品功能，对于此所引发的失效我司将不予保证。

We can't warrant against failure caused by any use of our product that deviates from the intended use as described in this product specification.