

P	LTR	DESCRIPTION	DATE	DWN	APVD
	NC	NEW RELEASE PER E.O. P17240	19APR2001	JA	RDR
	A	REVISED PER E-21-005400	12MAY2021	MR	IG

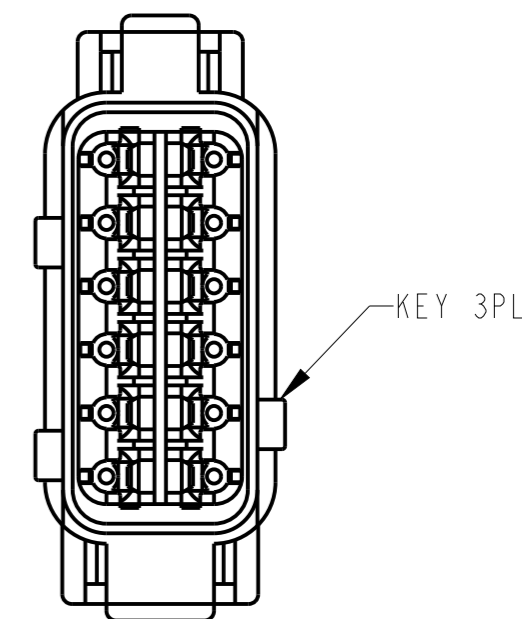
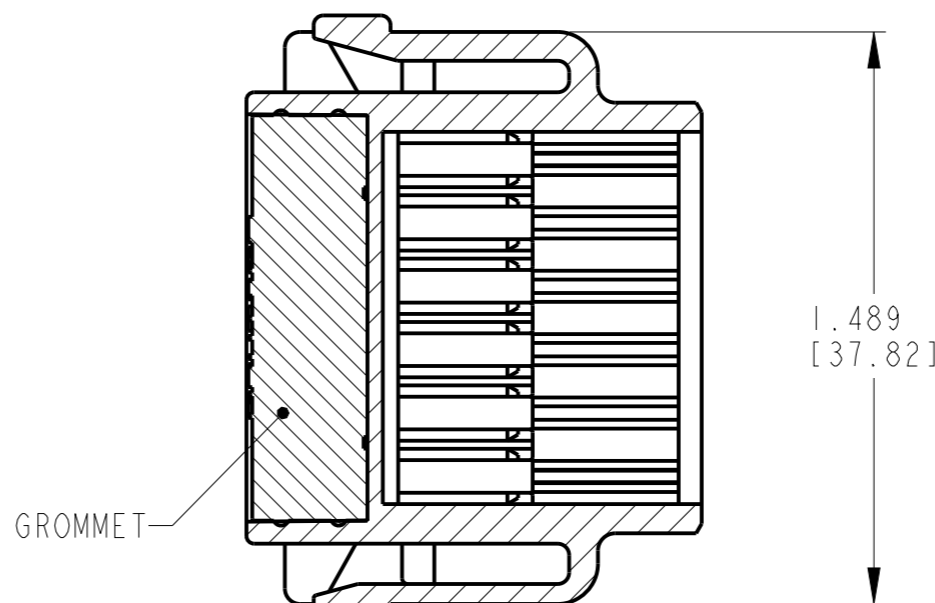
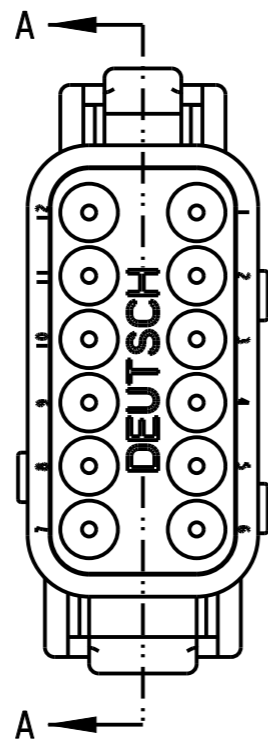
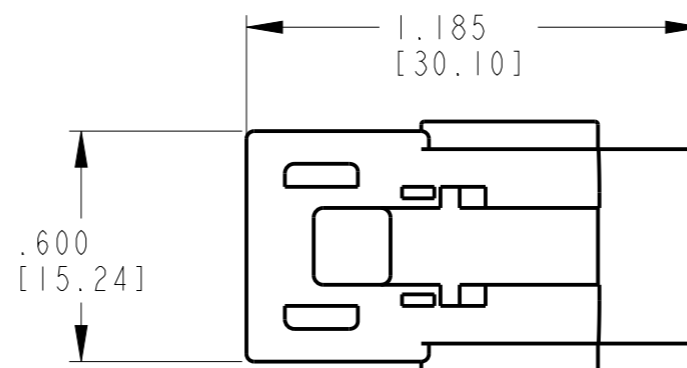
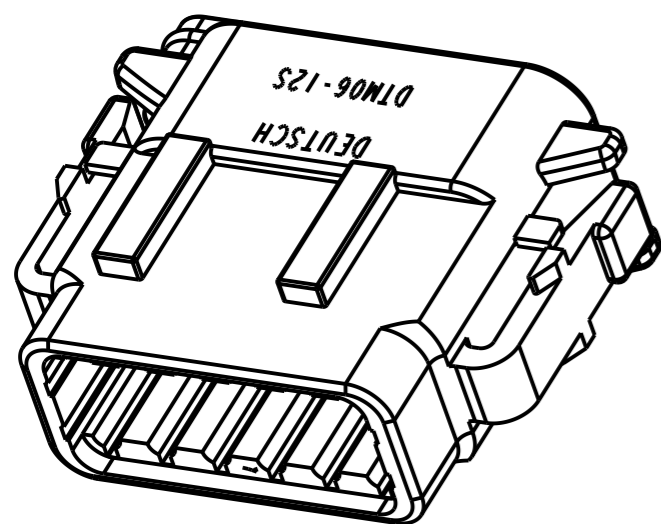

7. SEE SHEET 2 FOR OTHER KEY ARRANGEMENTS.

6 MATERIAL:
HOUSING: PA66 GF15
GROMMET: VMQ (BURNT RED)

5. THIS PLUG MATES WITH DTM04-12PX-XXXX RECEPTACLE.
(X = A,B,C,D KEYS; XXXX = ALL MODIFICATION)

4 FOR CONTACT AND WIRE PERFORMANCE AND APPLICATION CHARACTERISTICS SEE ENVELOPE DRAWING 0425-015-0000.

3. SECONDARY WEDGE LOCK SOLD SEPARATELY: WM-12S.

2. DELETED.

1. DELETED.

NOTES: UNLESS OTHERWISE SPECIFIED

CONTACT SIZE	MIN. INSUL. O.D.	MAX. INSUL. O.D.	WIRE RANGE [mm ²] REF ONLY
20	.053 [1.35]	.120 [3.05]	16-22 AWG [1.0-0.5]

THIS DRAWING IS A CONTROLLED DOCUMENT.		DWN A. APOSTOL 17APR2001														
DIMENSIONS: INCHES [mm]		CHK D. MEYER 18APR2001														
TOLERANCES UNLESS OTHERWISE SPECIFIED:		APVD R. REED 19APR2001	NAME PLUG 12 CONTACTS, SIZE 20 A,B,C,D KEYS DTM SERIES													
<table border="0"> <tr> <td>0 PLC</td> <td>±</td> </tr> <tr> <td>1 PLC</td> <td>±</td> </tr> <tr> <td>2 PLC</td> <td>±</td> </tr> <tr> <td>3 PLC</td> <td>±.025 [0.64]</td> </tr> <tr> <td>4 PLC</td> <td>±</td> </tr> <tr> <td>ANGLES</td> <td>±0°30'0"</td> </tr> </table>		0 PLC	±	1 PLC	±	2 PLC	±	3 PLC	±.025 [0.64]	4 PLC	±	ANGLES	±0°30'0"	PRODUCT SPEC 108-151010	SIZE A3	
0 PLC	±															
1 PLC	±															
2 PLC	±															
3 PLC	±.025 [0.64]															
4 PLC	±															
ANGLES	±0°30'0"															
MATERIAL 6		APPLICATION SPEC 114-151010	CAGE CODE 00779	DRAWING NO G=DTM06-12SX												
FINISH N/A		WEIGHT 12 g	RESTRICTED TO -													
		CUSTOMER DRAWING	SCALE 2:1	SHEET 1 OF 2 REV A												

REVISIONS

P	LTR	DESCRIPTION	DATE	DWN	APVD
-		SEE SHEET 1	-	-	-

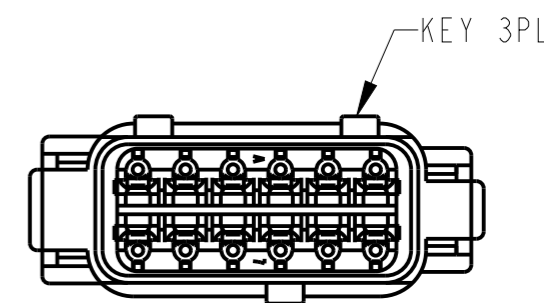
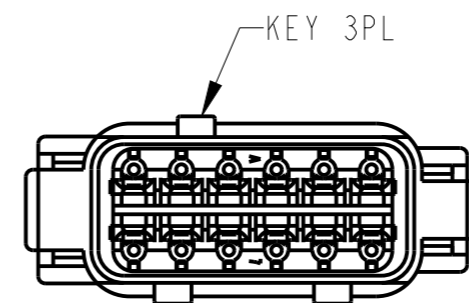
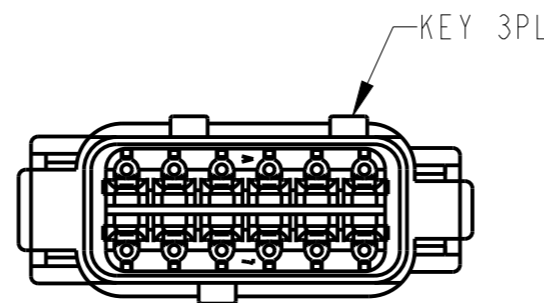
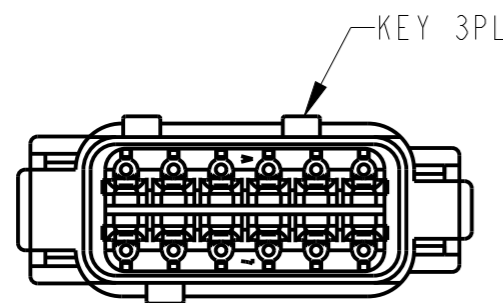
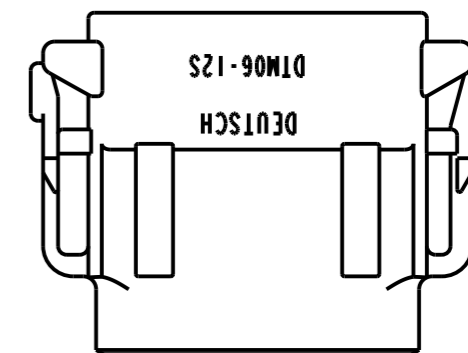
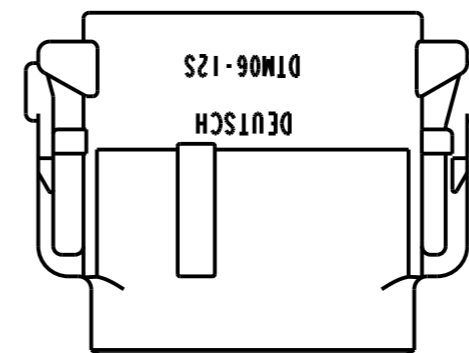
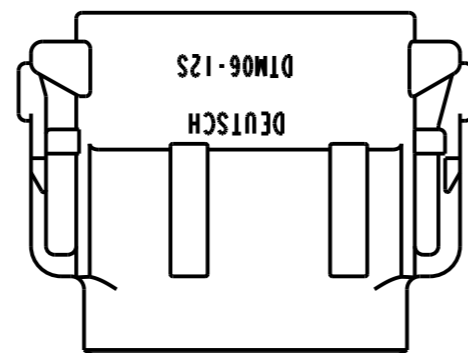
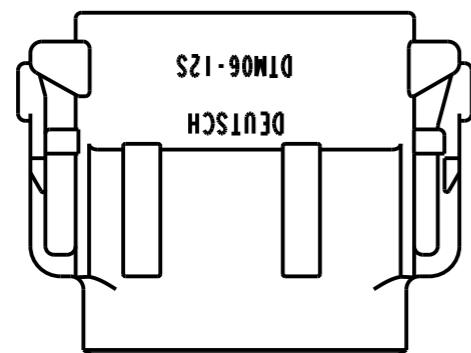

DTM06-12SA
KEY -A-
COLOR: GREY

DTM06-12SB
KEY -B-
COLOR: BLACK

DTM06-12SC
KEY -C-
COLOR: GREEN

DTM06-12SD
KEY -D-
COLOR: BROWN

THIS DRAWING IS A CONTROLLED DOCUMENT.

DIMENSIONS:
INCHES [mm]

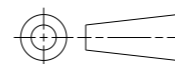

TOLERANCES UNLESS OTHERWISE SPECIFIED:

0 PLC	±
1 PLC	±
2 PLC	±
3 PLC	±.025 [0.64]
4 PLC	±
ANGLES	±0°30'0"



MATERIAL

FINISH

N/A

DWN A. APOSTOL 17APR2001

CHK D. MEYER 18APR2001

APVD R. REED 19APR2001

PRODUCT SPEC 108-151010

APPLICATION SPEC 114-151010

WEIGHT 12 g

CUSTOMER DRAWING

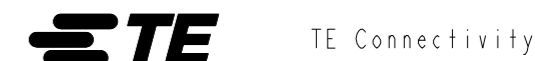

NAME
PLUG 12 CONTACTS, SIZE 20
A,B,C,D KEYS
DTM SERIES

SIZE	CAGE CODE	DRAWING NO	RESTRICTED TO
------	-----------	------------	---------------

A3	00779	DTM06-12SX	-
----	-------	------------	---

SCALE	SHEET	OF	REV
3:2	2	2	A